

# 300MHz to 11GHz Precision Dual RF Power Detector

## FEATURES

- Two Independent Temperature Compensated Schottky Diode RF Peak Detectors
- 45dB Channel-to-Channel Isolation at 2GHz
- Wide Input Frequency Range: 300MHz to 11GHz\*
- Wide Input Power Range: -32dBm to 12dBm
- Buffered Detector Outputs with Gain of 2x
- Adjustable  $V_{OUT}$  Starting Voltage
- Wide  $V_{CC}$  Range of 2.7V to 6V
- Low Operating Current: <math>500\mu A</math>/Channel
- Low Shutdown Current: <math>2\mu A</math>/Channel
- 4mm  $\times$  3mm DFN Package

## APPLICATIONS

- PA Forward and Reverse Power Monitor
- Dual PA Transmit Power Control
- 802.11a, b, g, 802.15, WiMAX
- PA Linearization
- Fixed Wireless Access
- RF Power Alarm
- Envelope Detector

## DESCRIPTION

The LTC<sup>®</sup>5533 is a dual channel RF power detector for RF applications operating in the 300MHz to 11GHz range. Two independent temperature compensated Schottky diode peak detectors and buffer amplifiers are combined in a small 4mm  $\times$  3mm DFN package.

The RF input voltage is peak detected using on-chip Schottky diodes. The detected voltage is buffered and supplied to the  $V_{OUT}$  pins. A power saving shutdown mode reduces current to less than  $2\mu A$ /channel. The initial output starting voltages can be precisely adjusted using the  $V_{OS}$  pins.

The LTC5533 operates with input power levels from -32dBm to 12dBm.

LT, LTC and LT are registered trademarks of Linear Technology Corporation. All other trademarks are the property of their respective owners.

\*Higher frequency operation is achievable with reduced performance. Consult factory for more information.

## TYPICAL APPLICATION

300MHz to 11GHz RF Power Detectors

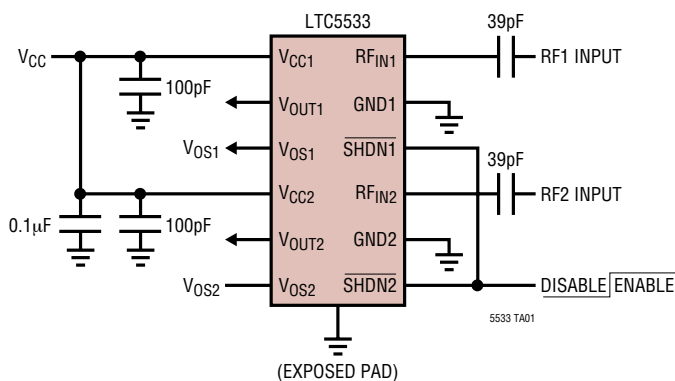

Output Voltage vs RF Input Power

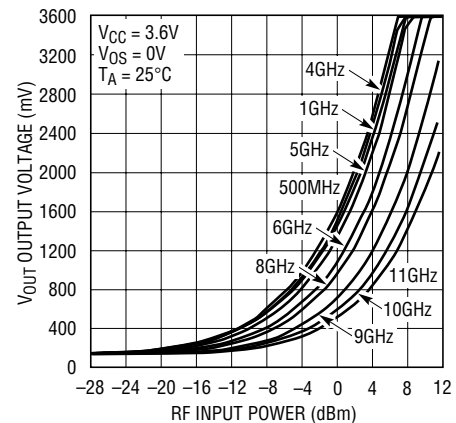

5533 TA02D

## ABSOLUTE MAXIMUM RATINGS

(Note 1)

$V_{CC1}$ ,  $V_{CC2}$ ,  $V_{OUT1}$ ,  $V_{OUT2}$ ,  $V_{OS1}$ ,  $V_{OS2}$  .....  $-0.3V$  to  $6.5V$   
 $RF_{IN1}$ ,  $RF_{IN2}$  Voltage ..... ( $V_{CC} \pm 1.25V$ ) to  $7V$   
 $RF_{IN1}$ ,  $RF_{IN2}$  Power (RMS) .....  $12dBm$   
 $SHDN1$ ,  $SHDN2$  Voltage to GND ..  $-0.3V$  to ( $V_{CC} + 0.3V$ )  
 $I_{VOUT1}$ ,  $I_{VOUT2}$  .....  $5mA$   
 Operating Temperature Range (Note 2) ..  $-40^{\circ}C$  to  $85^{\circ}C$   
 Maximum Junction Temperature .....  $125^{\circ}C$   
 Storage Temperature Range .....  $-65^{\circ}C$  to  $150^{\circ}C$

## PACKAGE/ORDER INFORMATION

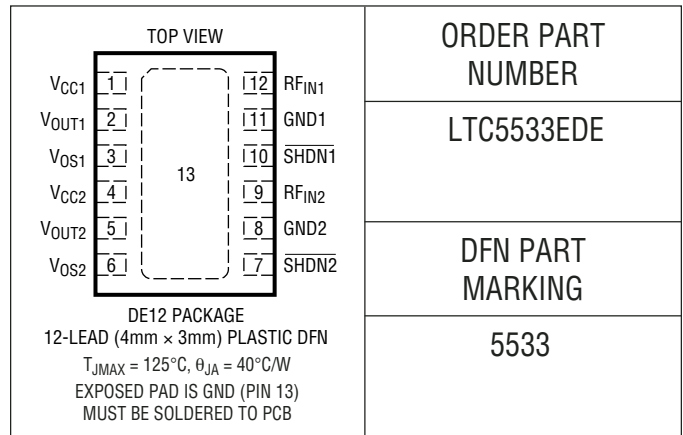

ORDER PART NUMBER

LTC5533EDE

DFN PART MARKING

5533

Consult LTC Marketing for parts specified with wider operating temperature ranges.

## ELECTRICAL CHARACTERISTICS

The ● denotes the specifications which apply over the full operating temperature range, otherwise specifications are at  $T_A = 25^{\circ}C$ .  $V_{CC} = 3.6V$ ,  $SHDN = V_{CC} = HI$ ,  $SHDN = 0V = LO$ , RF Input Signal is Off,  $V_{OS} = 0V$  and  $SHDN = HI$  unless otherwise noted. Limits below are for one channel unless otherwise noted.

PARAMETER	CONDITIONS	MIN	TYP	MAX	UNITS
$V_{CC}$ Operating Voltage		● 2.7		6	V
$I_{VCC}$ Operating Current	$I_{VOUT} = 0mA$	●	0.45	0.7	mA
$I_{VCC}$ Shutdown Current	$SHDN = LO$	●	0.01	2	$\mu A$
$V_{OUT}$ Start Voltage (No RF Input)	$R_{LOAD} = 2k$ , $V_{OS} = 0V$ $SHDN = LO$	● 85	110 to 150 1	170	mV mV
$V_{OUT}$ Output Current	$V_{OUT} = 1.75V$ , $V_{CC} = 2.7V$ , $\Delta V_{OUT} < 10mV$	● 2	4		mA
$V_{OUT}$ Enable Time	$SHDN = LO$ to HI, $C_{LOAD} = 33pF$ , $R_{LOAD} = 2k$	●	8	20	$\mu s$
$V_{OUT}$ Bandwidth	$C_{LOAD} = 33pF$ , $R_{LOAD} = 2k$ (Note 4)		2		MHz
$V_{OUT}$ Load Capacitance	(Note 6)	●		33	pF
$V_{OUT}$ Slew Rate	$V_{RFIN} = 1V$ Step, $C_{LOAD} = 33pF$ , $R_{LOAD} = 2k$ (Note 3)		3		V/ $\mu s$
$V_{OUT}$ Noise	$V_{CC} = 3V$ , Noise BW = 1.5MHz, 50 $\Omega$ RF Input Termination		1		mV <sub>P-P</sub>
$V_{OUT}$ Shutdown Resistance	Resistance Measured to Ground		280		$\Omega$
$V_{OS}$ Voltage Range		● 0		1	V
$V_{OS}$ Input Current	$V_{OS} = 1V$	●	-0.5	0.5	$\mu A$
$SHDN$ Voltage, Chip Disabled	$V_{CC} = 2.7V$ to $6V$	●		0.35	V
$SHDN$ Voltage, Chip Enabled	$V_{CC} = 2.7V$ to $6V$	●	1.4		V
$SHDN$ Input Current	$SHDN = 3.6V$	●	22	36	$\mu A$
$RF_{IN}$ Input Frequency Range			300 to 11000		MHz
$RF_{IN}$ Input Power Range	RF Frequency = 300MHz to 7GHz (Note 5, 6) $V_{CC} = 2.7V$ to $6V$		-32 to 12		dBm
$RF_{IN}$ AC Input Resistance	$f = 1000MHz$ , $P_{in} = -25dBm$		220		$\Omega$
$RF_{IN}$ Input Shunt Capacitance	$f = 1000MHz$ , $P_{in} = -25dBm$		0.65		pF
Channel to Channel Isolation	$f = 2GHz$		45		dB

**Note 1:** Absolute Maximum Ratings are those values beyond which the life of a device may be impaired.

**Note 2:** Specifications over the  $-40^{\circ}C$  to  $85^{\circ}C$  operating temperature range are assured by design, characterization and correlation with statistical process controls.

**Note 3:** The rise time at  $V_{OUT}$  is measured between 1.3V and 2.3V.

**Note 4:** Bandwidth is calculated based on the 10% to 90% rise time equation:  $BW = 0.35/\text{rise time}$ .

**Note 5:** RF performance is production tested at 1800MHz

**Note 6:** Guaranteed by design.

# TYPICAL PERFORMANCE CHARACTERISTICS (For one channel. $\overline{\text{SHDN}} = V_{CC}$ , unless otherwise specified.)

**Output Starting Voltage vs Supply Voltage (RF Input Signal Off,  $V_{OS} = 0V$ )**

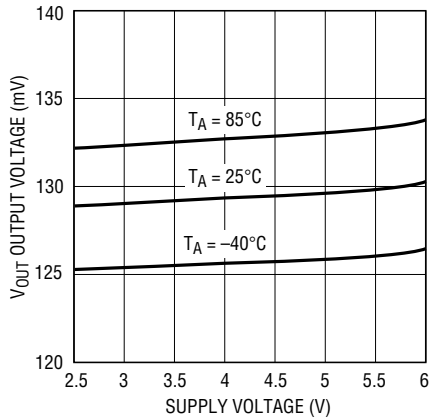

5533 G01

**Supply Current vs Supply Voltage (RF Input Signal Off,  $V_{OS} = 0V$ )**

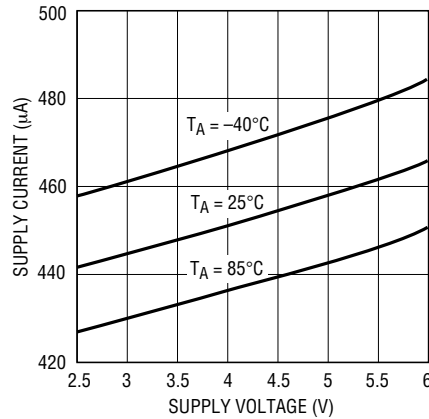

5533 G02

**Shutdown Current vs Supply Voltage (RF Input Signal Off,  $V_{OS} = 0V$ ,  $\overline{\text{SHDN}} = 0V$ )**

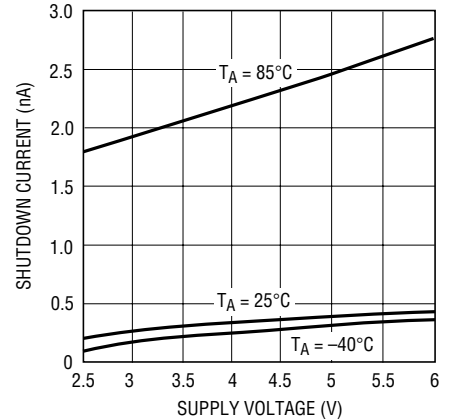

5533 G03

**Typical Detector Characteristics, 300MHz**

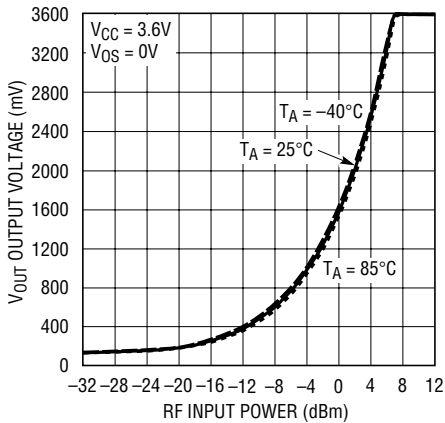

5533 G04

**Typical Detector Characteristics, 1GHz**

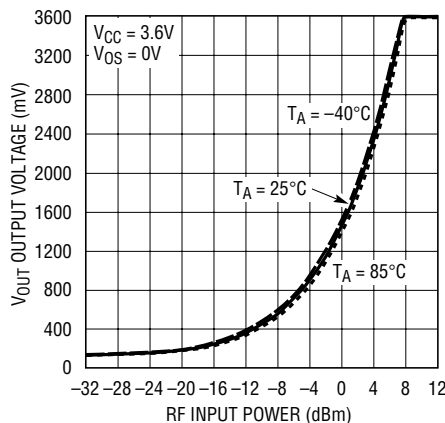

5533 G05

**Typical Detector Characteristics, 2GHz**

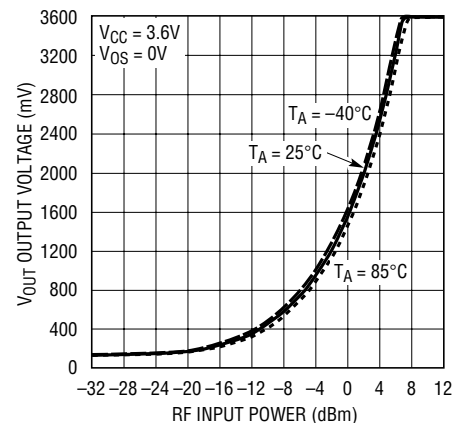

5533 G06

**Typical Detector Characteristics, 3GHz**

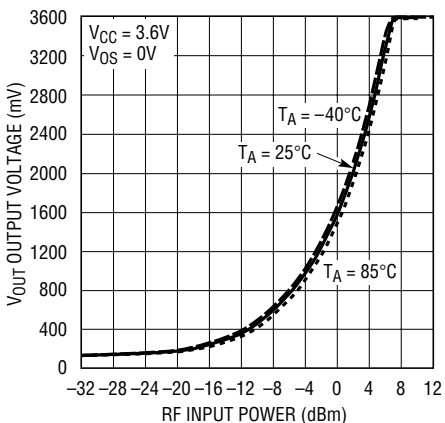

5533 G07

**Typical Detector Characteristics, 5GHz**

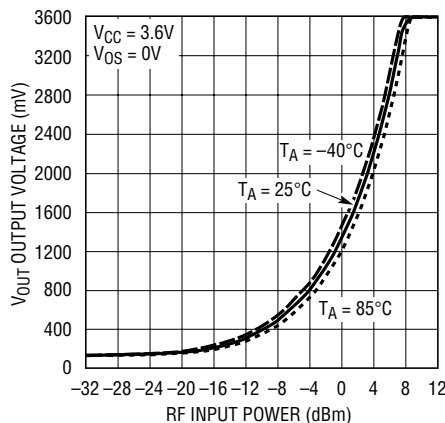

5533 G08

**Typical Detector Characteristics, 7GHz**

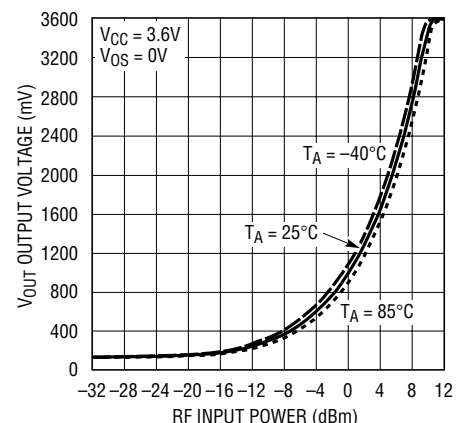

5533 G09

5533f

**TYPICAL PERFORMANCE CHARACTERISTICS** (For one channel.  $\overline{SHDN} = V_{CC}$ , unless otherwise specified.)

**$V_{OUT}$  Slope vs RF Input Power at 300MHz**

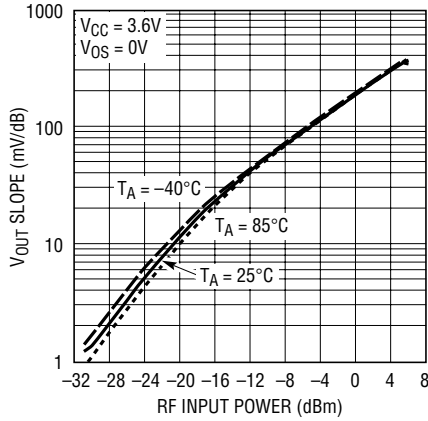

5533 G10

**$V_{OUT}$  Slope vs RF Input Power at 1GHz**

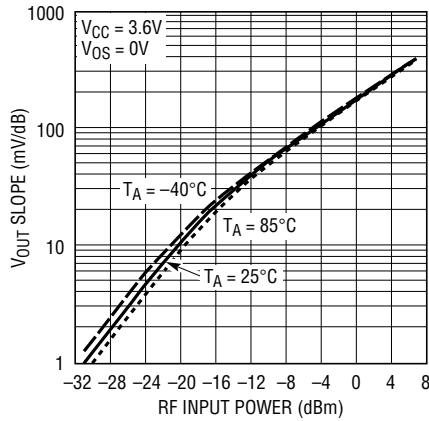

5533 G11

**$V_{OUT}$  Slope vs RF Input Power at 2GHz**

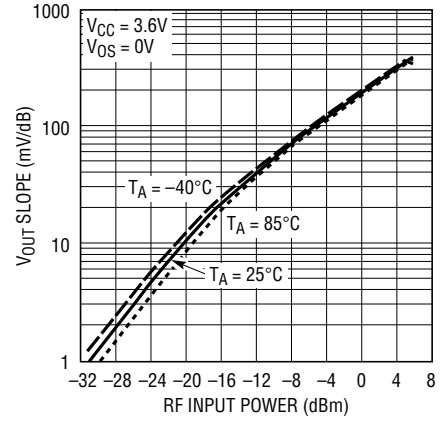

5533 G12

**$V_{OUT}$  Slope vs RF Input Power at 3GHz**

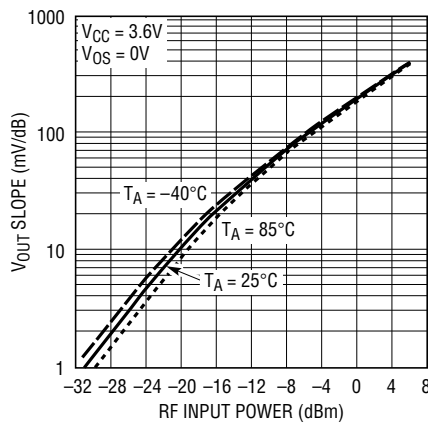

5533 G13

**$V_{OUT}$  Slope vs RF Input Power at 5GHz**

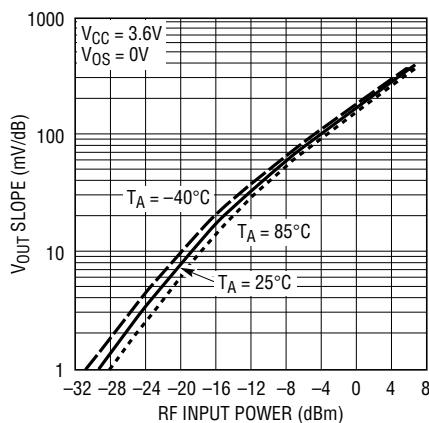

5533 G14

**$V_{OUT}$  Slope vs RF Input Power at 7GHz**

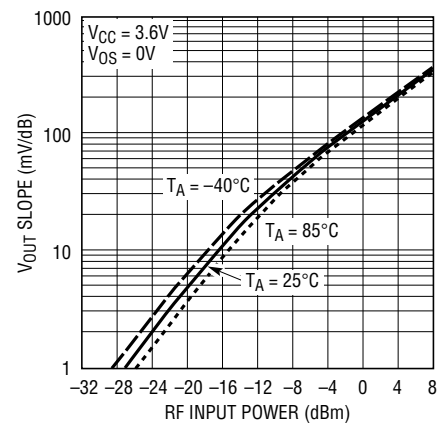

5533 G15

**$V_{OUT}$  Variation Relative to 25°C vs RF Input Power at 300MHz**

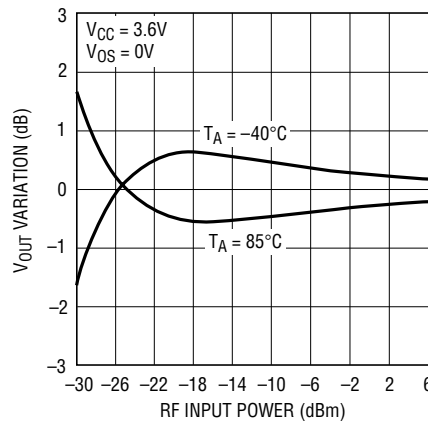

5533 G16

**$V_{OUT}$  Variation Relative to 25°C vs RF Input Power at 1GHz**

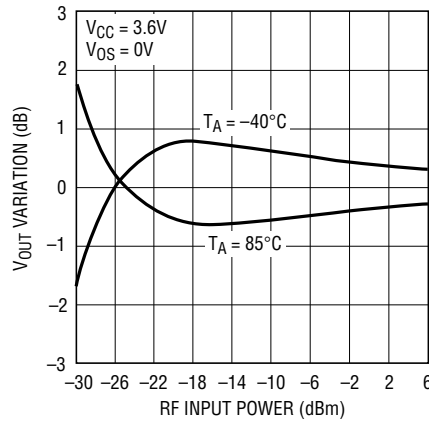

5533 G17

**$V_{OUT}$  Variation Relative to 25°C vs RF Input Power at 2GHz**

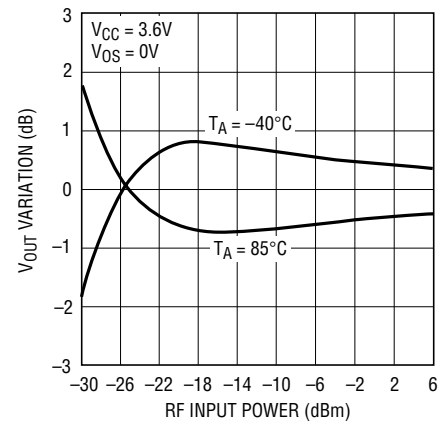

5533 G18

**TYPICAL PERFORMANCE CHARACTERISTICS** (For one channel.  $\overline{\text{SHDN}} = V_{CC}$ , unless otherwise specified.)

**$V_{OUT}$  Variation Relative to 25°C vs RF Input Power at 3GHz**

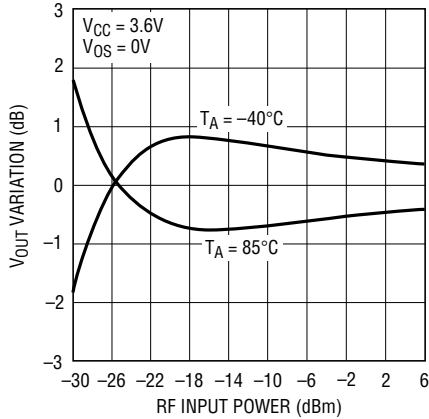

5533 G19

**$V_{OUT}$  Variation Relative to 25°C vs RF Input Power at 5GHz**

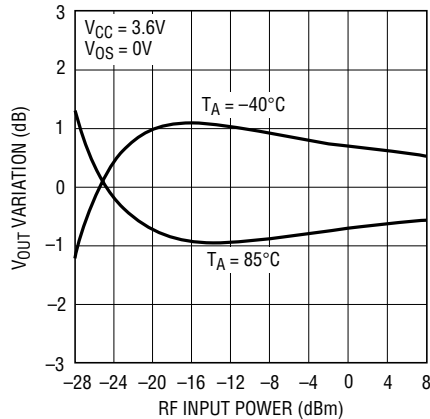

5533 G20

**$V_{OUT}$  Variation Relative to 25°C vs RF Input Power at 7GHz**

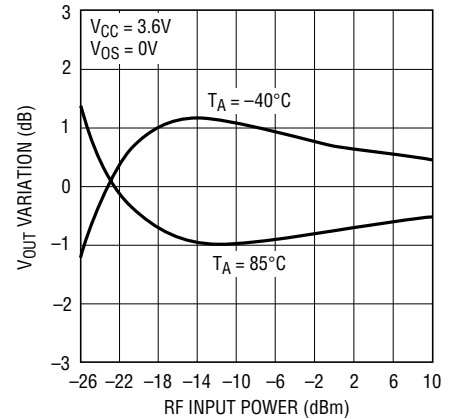

5533 G21

**Example  $V_{OUT1} - V_{OUT2}$  Mismatch with No RF Signal Input**

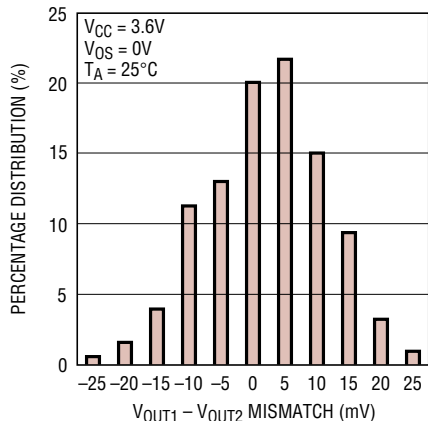

5533 G22

**Example  $V_{OUT1} - V_{OUT2}$  Mismatch with -14dBm RF Signal Input at 1.8GHz**

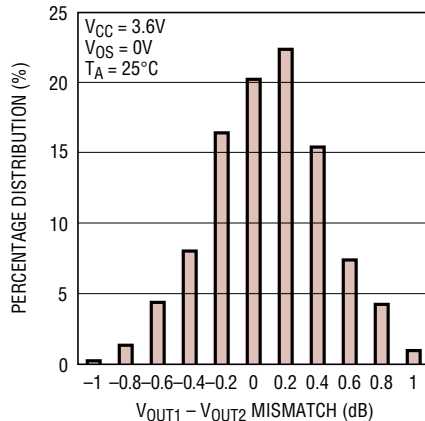

5533 G23

**$V_{OUT}$  vs RF Input Power and  $V_{CC}$  Supply Voltage,  $f_{RF} = 2GHz$**

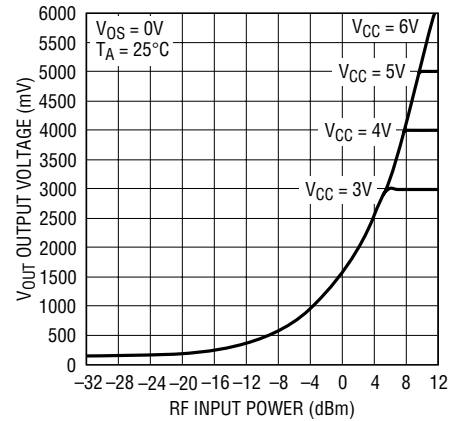

5533 G24

**$V_{OUT}$  vs RF Input Power and  $V_{OS}$ ,  $f_{RF} = 2GHz$**

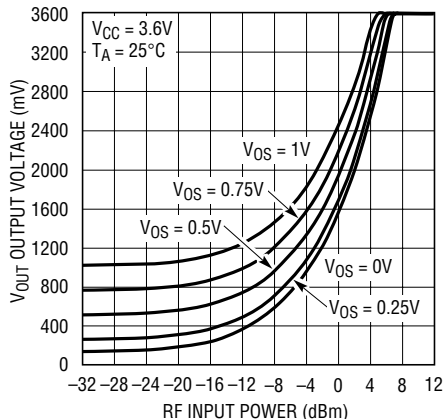

5533 G25

**Channel-to-Channel Isolation vs RF Input Frequency**

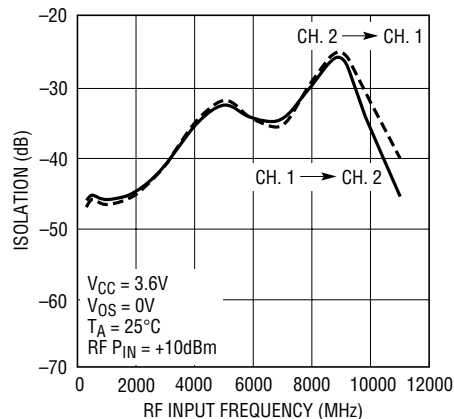

5533 G26

**Output Delay vs RF Input Power**

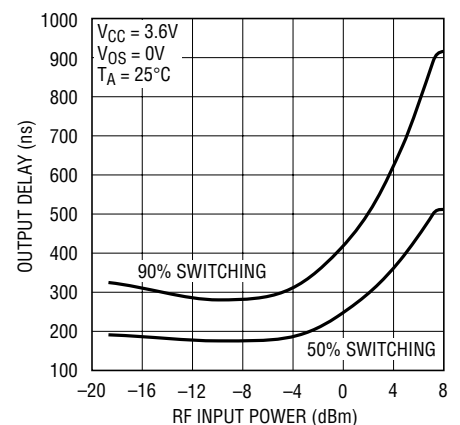

5533 G27

## TYPICAL PERFORMANCE CHARACTERISTICS

RF<sub>IN</sub> Input Impedance (P<sub>in</sub> = 0dBm, V<sub>CC</sub> = 3.6V, T<sub>A</sub> = 25°C)

FREQUENCY (GHz)	RESISTANCE (Ω)	REACTANCE (Ω)
0.30	290.45	-136.22
0.50	234.41	-162.54
0.70	178.25	-170.53
0.90	137.31	-159.89
1.10	109.17	-147.57
1.30	86.30	-136.18
1.50	68.65	-121.74
1.70	57.48	-107.60
1.90	49.79	-96.72
2.10	43.56	-86.70
2.30	38.67	-77.91
2.50	34.82	-70.13
2.70	31.68	-62.86
2.90	29.13	-56.01
3.10	27.17	-49.83
3.30	25.73	-44.24
3.50	24.56	-39.74
3.70	23.18	-35.35
3.90	22.31	-30.62
4.10	20.73	-26.88
4.30	19.88	-22.31
4.50	19.40	-18.23
4.70	19.05	-14.25
4.90	19.08	-10.21
5.10	19.55	-6.30
5.30	20.85	-2.84
5.50	21.94	-1.49
5.70	20.60	-0.07
5.90	19.29	2.99
6.10	18.69	6.61
6.30	18.53	10.39
6.50	18.74	14.35
6.70	19.79	17.91
6.90	19.75	20.77
7.00	19.99	22.47

S11 Forward Reflection  
Impedance

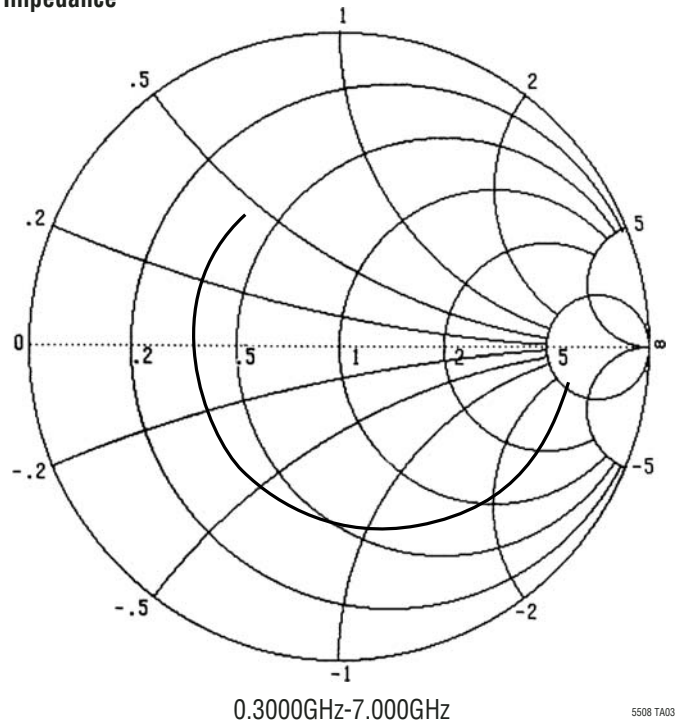

## TYPICAL PERFORMANCE CHARACTERISTICS

RF<sub>IN</sub> Input Impedance (P<sub>in</sub> = -25dBm, V<sub>CC</sub> = 3.6V, T<sub>A</sub> = 25°C)

FREQUENCY (GHz)	RESISTANCE (Ω)	REACTANCE (Ω)
0.30	216.45	-76.47
0.50	190.63	-98.28
0.70	161.98	-112.03
0.90	133.17	-111.53
1.10	113.08	-109.05
1.30	94.55	-107.08
1.50	75.33	-98.50
1.70	63.52	-88.19
1.90	55.19	-80.05
2.10	48.64	-72.23
2.30	43.73	-64.81
2.50	39.71	-58.31
2.70	36.47	-52.27
2.90	33.69	-46.77
3.10	31.61	-41.25
3.30	29.78	-36.61
3.50	28.27	-32.39
3.70	26.63	-28.12
3.90	26.12	-23.97
4.10	24.20	-20.75
4.30	23.28	-16.69
4.50	22.60	-12.77
4.70	22.21	-9.08
4.90	22.15	-5.24
5.10	22.61	-1.58
5.30	23.90	1.53
5.50	24.97	2.62
5.70	23.51	4.00
5.90	22.25	6.94
6.10	21.57	10.62
6.30	21.43	14.02
6.50	21.69	17.77
6.70	22.68	21.24
6.90	22.81	24.21
7.00	23.07	25.56

S11 Forward Reflection  
Impedance

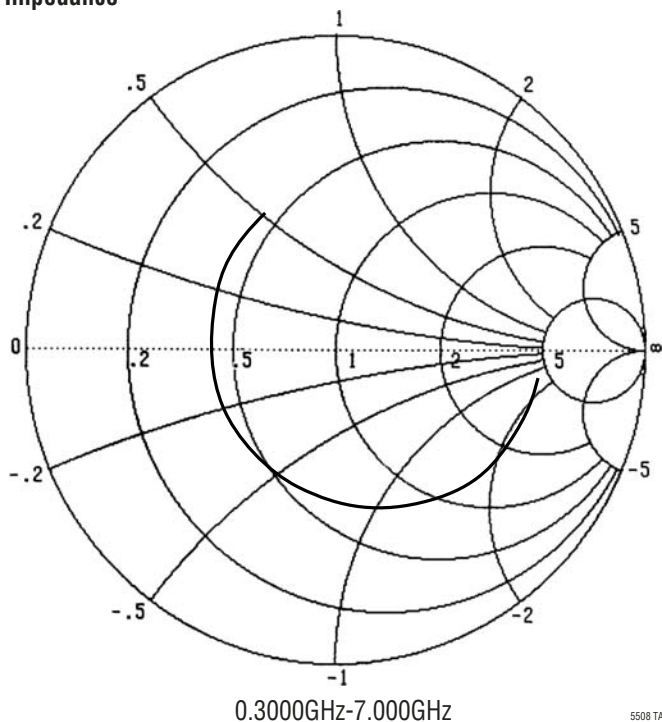

5508 TA04

## PIN FUNCTIONS

**V<sub>CC1</sub>, V<sub>CC2</sub> (Pins 1, 4):** Power Supply Voltage, 2.7V to 6V. V<sub>CC</sub> should be bypassed appropriately with ceramic capacitors.

**V<sub>OUT1</sub>, V<sub>OUT2</sub> (Pins 2, 5):** Detector Outputs.

**V<sub>OS1</sub>, V<sub>OS2</sub> (Pins 3, 6):** V<sub>OUT</sub> Offset Voltage Adjustments. These pins adjust the starting V<sub>OUT</sub> voltage when no RF signal is present. For V<sub>OS</sub> from 0V to 130mV, V<sub>OUT</sub> is unaffected by V<sub>OS</sub>. For V<sub>OS</sub> > 130mV, V<sub>OUT</sub> is the sum of V<sub>OS</sub> plus the detected RF signal.

**SHDN1, SHDN2 (Pin 10, 7):** Shutdown Inputs. A logic low on the SHDN pin places the corresponding detector in shutdown mode. A logic high enables the detector. SHDN

has an internal 160k pulldown resistor to ensure that the detector is shutdown when no SHDN input is applied. In shutdown V<sub>OUT</sub> is connected to ground via a 280Ω resistor. Channels can be shut down independently.

**GND1, GND2 (Pins 11, 8):** Ground.

**RF<sub>IN1</sub>, RF<sub>IN2</sub> (Pins 12, 9):** RF Input Voltage. Referenced to V<sub>CC</sub>. A coupling capacitor must be used to connect to the RF signal source. These pins have internal 500Ω terminations, Schottky diode detectors and peak detector capacitors.

**Exposed Pad (Pin13):** Ground.

## BLOCK DIAGRAM (One Channel)

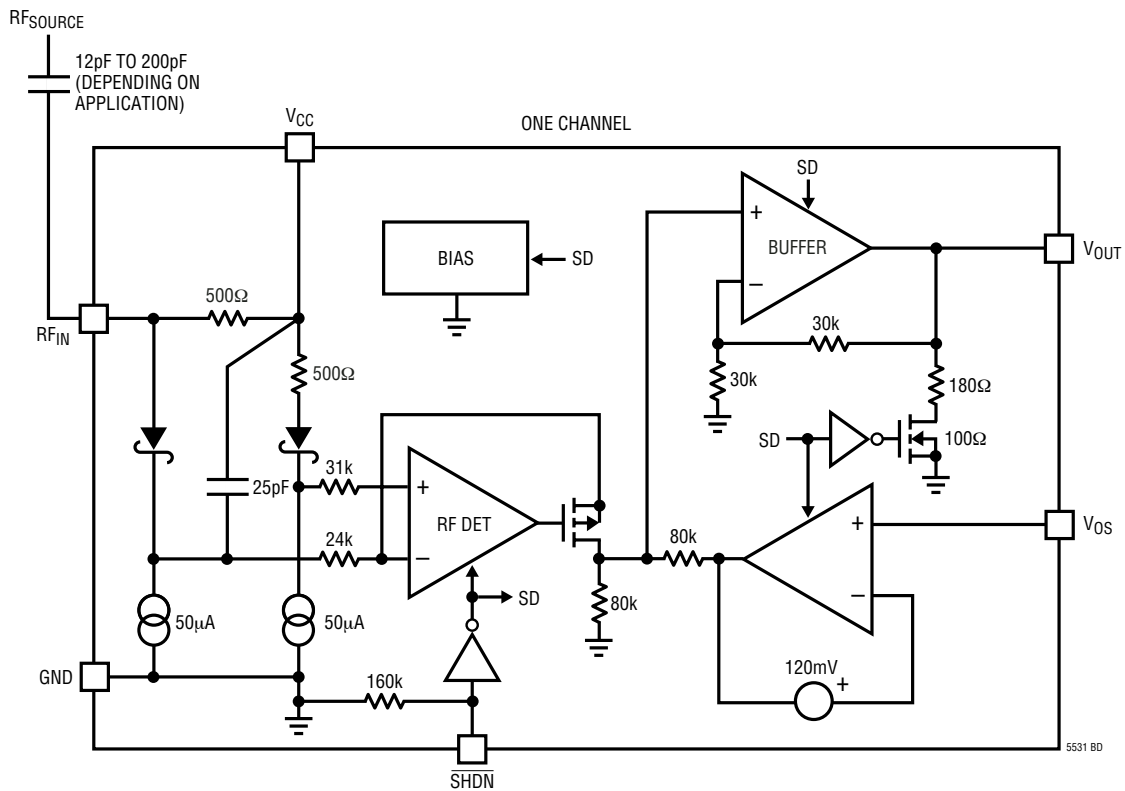



## APPLICATIONS INFORMATION

### Operation

The LTC5533 contains two RF detector dice in one package forming two independent RF detector channels. Each channel provides RF power detection over frequencies ranging from 300MHz to 11GHz. Channel functions include an internal frequency compensated buffer amplifier with the gain set to 2x, an RF Schottky diode peak detector and level shift amplifier to convert the RF input signal to low frequency and a delay circuit to avoid voltage transients at  $V_{OUT}$  when powering up. The LTC5533 has both shutdown and starting voltage adjustment capabilities.

### Buffer Amplifiers

The output buffer amplifiers are capable of supplying typically 4mA into a load. These amplifiers have bandwidths of 2MHz and a fixed internal gain of two.

The  $V_{OS}$  inputs control the DC input voltages to the buffer amplifiers.  $V_{OS}$  must be connected to ground if the DC output voltage is not to be changed. The buffers are initially trimmed to approximately 130mV with  $V_{OS}$  connected to ground.

The  $V_{OS}$  pins are used to change the initial  $V_{OUT}$  starting voltage. This function enables the LTC5533 outputs to

span the input range of a variety of analog-to-digital converters.  $V_{OUT}$  will not change until  $V_{OS}$  exceeds 130mV. The voltage at  $V_{OUT}$  for  $V_{OS} > 130mV$  and with no RF signal present is:

$$V_{OUT} = V_{OS}$$

$V_{OUT}$  will track  $V_{OS}$  above 130mV.

### RF Detectors

The internal RF Schottky diode peak detectors and level shift amplifiers convert the RF input signals to a low frequency signal. The detectors demonstrate excellent efficiency and linearity over a wide range of input power. The Schottky diodes are biased at about 55 $\mu$ A and drive 25pF internal peak detector capacitors.

### Applications

The LTC5533 can be used as a self-standing signal strength measuring receiver for a wide range of input signals from -32dBm to 12dBm for frequencies from 300MHz to 11GHz. Operation at higher frequencies is achievable with reduced performance. Consult factory for more information. Figure 1 plots the output voltage as a function of RF input power of an 11GHz CW input signal.

Demo Board Schematic

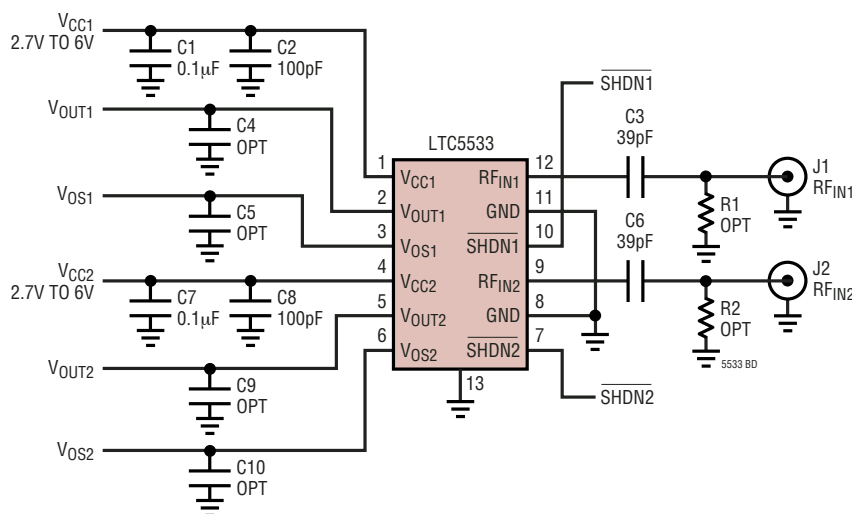

APPLICATIONS INFORMATION

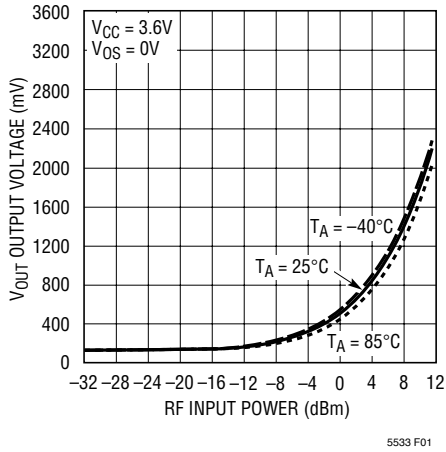

Figure 1. Typical Detector Characteristics, 11GHz

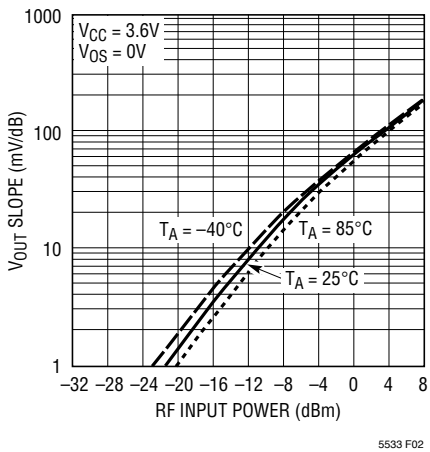

Figure 2. V<sub>OUT</sub> Slope vs RF Input Power at 11GHz

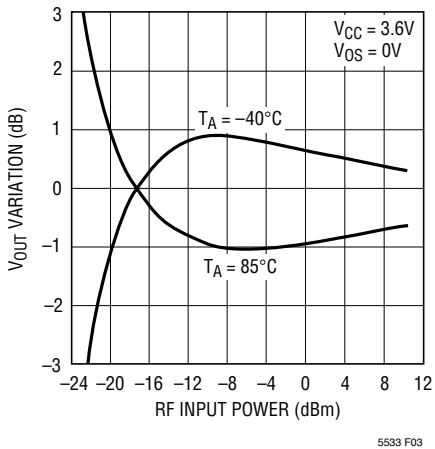

Figure 3. V<sub>OUT</sub> Variation at -40°C and at 85°C vs RF Input Power at 11GHz, Normalized to Room Temperature (25°C) Results.

Figure 2 shows the corresponding slope of the 11GHz response, and Figure 3 shows the variation of the output voltage vs RF input power at -40°C and 85°C, normalized to the room temperature (25°C) results.

The LTC5533 can be used as a demodulator for AM and ASK modulated signals with data rates up to 2MHz. Depending on specific application needs, the detector outputs can be split between two branches, providing AC-coupled data (or audio) output and a DC-coupled RSSI output for signal strength measurements and AGC.

The LTC5533 can also be used for RF power detection and control. Figure 4 is an example of an LTC5533 used for dual band mobile phone transmitter power control.

The LTC5533 consists of two separate RF detector dice packaged together. Consequently, detector-to-detector isolation is good—typically 45dB at 2GHz. Output matching is good, but not precise. The characterization plots in the Typical Performance Characteristics show that the typical output voltage mismatch is within ±25mV with no RF input signal present. With -14dBm RF input signal, the typical equivalent mismatch is within ±1dB.

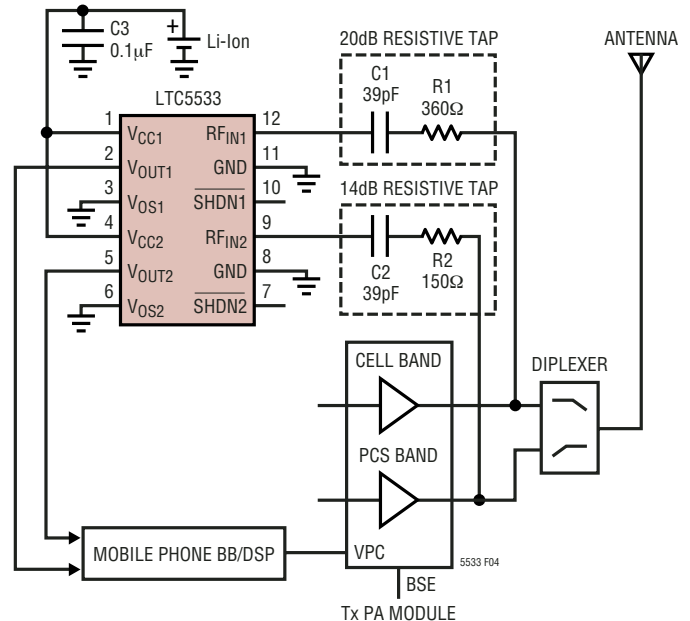
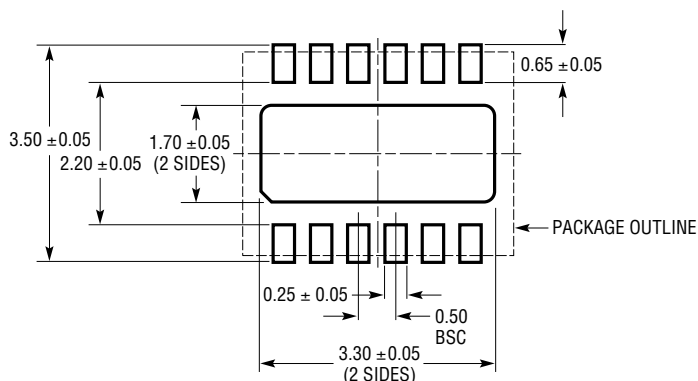

Figure 4. Dual Band Mobile Phone Transmitter Power Control with LTC5533

# PACKAGE DESCRIPTION

## DE Package 12-Lead Plastic DFN (4mm × 3mm) (Reference LTC DWG # 05-08-1695)



RECOMMENDED SOLDER PAD PITCH AND DIMENSIONS

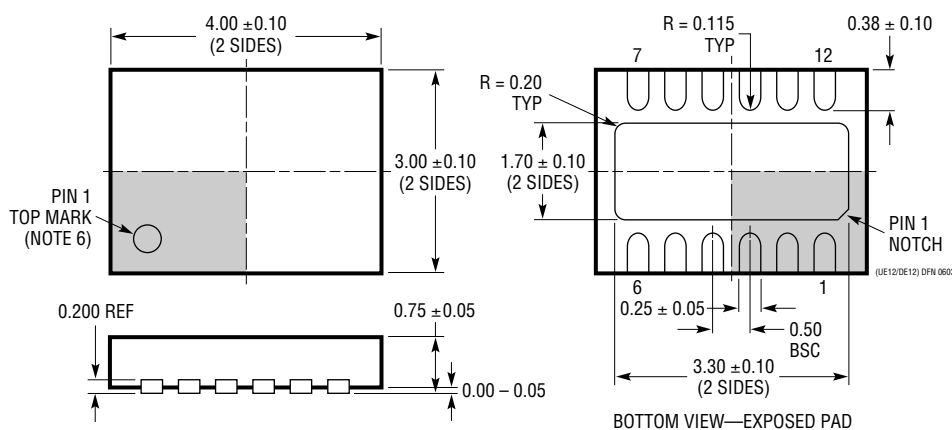

NOTE:

1. DRAWING PROPOSED TO BE A VARIATION OF VERSION (WGED) IN JEDEC PACKAGE OUTLINE M0-229
2. DRAWING NOT TO SCALE
3. ALL DIMENSIONS ARE IN MILLIMETERS
4. DIMENSIONS OF EXPOSED PAD ON BOTTOM OF PACKAGE DO NOT INCLUDE MOLD FLASH. MOLD FLASH, IF PRESENT, SHALL NOT EXCEED 0.15mm ON ANY SIDE
5. EXPOSED PAD SHALL BE SOLDER PLATED
6. SHADED AREA IS ONLY A REFERENCE FOR PIN 1 LOCATION ON THE TOP AND BOTTOM OF PACKAGE

## RELATED PARTS

PART NUMBER	DESCRIPTION	COMMENTS
<b>Infrastructure</b>		
LT <sup>®</sup> 5511	High Linearity Upconverting Mixer	RF Output to 3GHz, 17dBm IIP3, Integrated LO Buffer
LT5512	DC-3GHz High Signal Level Downconverting Mixer	DC to 3GHz, 21dBm IIP3, Integrated LO Buffer
LT5514	Ultralow Distortion, IF Amplifier/ADC Driver with Digitally Controlled Gain	850MHz Bandwidth, 47dBm OIP3 at 100MHz, 10.5dB to 33dB Gain Control Range
LT5515	1.5GHz to 2.5GHz Direct Conversion Quadrature Demodulator	20dBm IIP3, Integrated LO Quadrature Generator
LT5516	0.8GHz to 1.5GHz Direct Conversion Quadrature Demodulator	21.5dBm IIP3, Integrated LO Quadrature Generator
LT5517	40MHz to 900MHz Direct Conversion Quadrature Demodulator	21dBm IIP3, Integrated LO Quadrature Generator
LT5519	0.7GHz to 1.4GHz High Linearity Upconverting Mixer	17.1dBm IIP3, 50Ω Single Ended RF and LO Ports
LT5520	1.3GHz to 2.3GHz High Linearity Upconverting Mixer	15.9dBm IIP3, 50Ω Single Ended RF and LO Ports
LT5521	3.7GHz Very High Linearity Mixer	24.2dBm IIP3 at 1.95GHz, 12.5dB NF, -42dBm LO Leakage
LT5522	600MHz to 2.7GHz High Linearity Downconverting Mixer	4.5V to 5.25V Supply, 25dBm IIP3 at 900MHz, NF = 12.5dB, 50Ω Single-Ended RF and LO Ports
LT5524	Low Power, Low Distortion ADC Driver with Digitally Programmable Gain	450MHz Bandwidth, 40dBm OIP3, 4.5dB to 27dB Gain Control Range
LT5525	0.9GHz to 2.5GHz High Linearity, Low Power Downconverting Mixer	17.6dBm IIP3 at 1.9GHz, On-Chip 50Ω RF and LO Matching, I <sub>CC</sub> = 28mA
LT5526	Broadband High Linearity, Low Power Downconverting Mixer	16.5dBm IIP3 at 0.9GHz, 11dB NF at 0.9GHz, I <sub>CC</sub> = 28mA
LT5528	1.6GHz to 2.45GHz High Linearity Direct Quadrature Modulator	21.8dBm OIP3 at 2GHz, -159dBm/Hz, Noise Floor, All Ports 50Ω Matched, Single-Ended RF and LO Ports
<b>RF Power Detectors</b>		
LT5504	800MHz to 2.7GHz RF Measuring Receiver	80dB Dynamic Range, Temperature Compensated, 2.7V to 5.25V Supply
LTC5505	300MHz to 3GHz RF Power Detectors	LTC5505-1: -28dBm to 18dBm Range, LTC5505-2: -32dBm to 12dBm Range, Temperature Compensated, 2.7V to 6V Supply
LTC5507	100kHz to 1000MHz RF Power Detector	-34dBm to 14dBm Range, Temperature Compensated, 2.7V to 6V Supply
LTC5508	300MHz to 7GHz RF Power Detector	-32dBm to 12dBm Range, Temperature Compensated, SC70 Package
LTC5509	300MHz to 3GHz RF Power Detector	36dB Dynamic Range, Temperature Compensated, SC70 Package
LTC5530	300MHz to 7GHz Precision RF Power Detector	Precision V <sub>OUT</sub> Offset Control, Shutdown and Adjustable Gain
LTC5531	300MHz to 7GHz Precision RF Power Detector	Precision V <sub>OUT</sub> Offset Control, Shutdown and Adjustable Offset
LTC5532	300MHz to 7GHz Precision RF Power Detector	Precision V <sub>OUT</sub> Offset Control, Adjustable Gain and Offset
LT5534	50MHz to 3GHz RF Power Detector	60dB Dynamic Range, Temperature Compensated, SC70 Package
LTC5535	300MHz to 7GHz Precision RF Detector with 12MHz Amplifier	Precision V <sub>OUT</sub> Offset Control, Adjustable Gain and Offset
LTC5536	600MHz to 7GHz Precision RF Detector With Fast Comparator Output	-26dBm to 12dBm Range, 2mA Supply Current at 2V to 6V Supply, Latch Enable Output
<b>RF Power Controllers</b>		
LTC4400	SOT-23 RF PA Controller	Multiband GSM/DCS/GPRS Phones, 45dB Dynamic Range, 450kHz Loop BW
LTC4401	SOT-23 RF PA Controller	Multiband GSM/DCS/GPRS Phones, 45dB Dynamic Range, 250kHz Loop BW
LTC4402	Multiband RF Power Controller	Multiband GSM/GPRS/EDGE Mobile Phones LTC4402-1: Single Channel Output Control LTC4402-2: Dual Channel Output Control
LTC4403	RF Power Controller for EDGE/TDMA	Multiband GSM/GPRS/EDGE Mobile Phones, 250kHz Loop BW