



Innovative **Technology**
for a **Connected** World

ThermaTEC™ Series HT3,12,F2,3030 Thermoelectric Modules



The ThermoTEC™ Series of thermoelectric modules (TEMs) are designed to operate under cycling conditions or high temperature applications.

This product line is available in multiple configurations and is ideal for applications that require both heating and cooling mode (reverse polarity) or power generation. Assembled with proprietary solder construction, Bismuth Telluride semiconductor material and thermally conductive Aluminum Oxide ceramics, the ThermoTEC™ Series is designed for higher current and larger heat-pumping applications.

FEATURES

- Thermal Cycling Durability
- Power Cycling Reliability
- Precise Temperature Control
- Strong Lead Attachment
- RoHS Compliant
- Continuous Operation at High Temperatures

APPLICATIONS

- Analytical Instrumentation
- PCR Cyclers
- Thermal Test Sockets
- Electronic Enclosure Cooling
- Chillers (Liquid Cooling)
- Power Generation

PERFORMANCE SPECIFICATIONS

Hot Side Temperature (°C)	25°C	50°C
Qmax (Watts)	24.7	27.2
Delta Tmax (°C)	63	75
I _{max} (Amps)	2.9	2.9
V _{max} (Volts)	14.5	16.4
Module Resistance (Ohms)	4.65	5.24

SUFFIX	THICKNESS (PRIOR TO TINNING)	FLATNESS & PARALLELISM	HOT FACE	COLD FACE	Lead Length
11	0.126" ± 0.005"	0.002" / 0.0035"	Lapped	Lapped	6.0
TA	0.126" ± 0.001"	0.001" / 0.001"	Lapped	Lapped	6.0"
TB	0.126" ± 0.0005"	0.0005" / 0.0005"	Lapped	Lapped	6.0"

SEALING OPTION

SUFFIX	SEALANT	COLOR	TEMP RANGE	DESCRIPTION
R	RTV	White	-60 to 204 °C	Non-corrosive, silicone adhesive sealant
E	Epoxy	Black	-55 to 150 °C	Low density syntactic foam epoxy encapsulant

global solutions: local support™

Americas: +1 888.246.9050

Europe: +46.31.420530

Asia: +86.755.2714.1166

clv.customerpos@lairdtech.com

www.lairdtech.com

ThermaTEC™ Series HT3,12,F2,3030

Thermoelectric Modules

Performance Curves at $T_h = 25^\circ\text{C}$

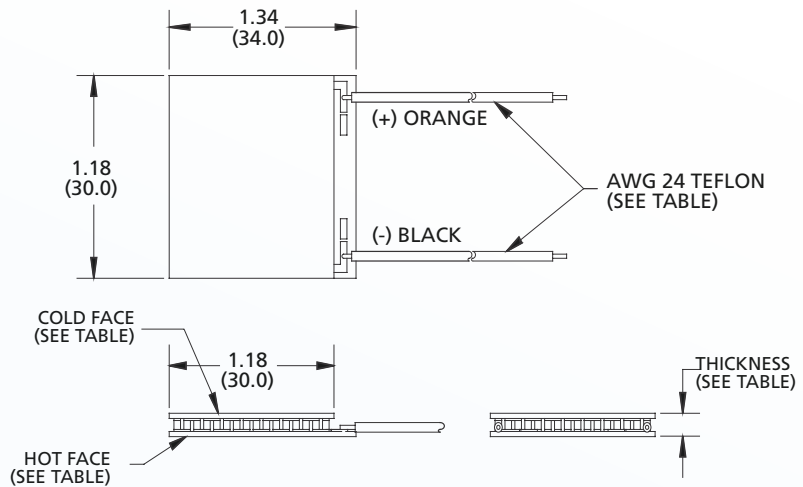
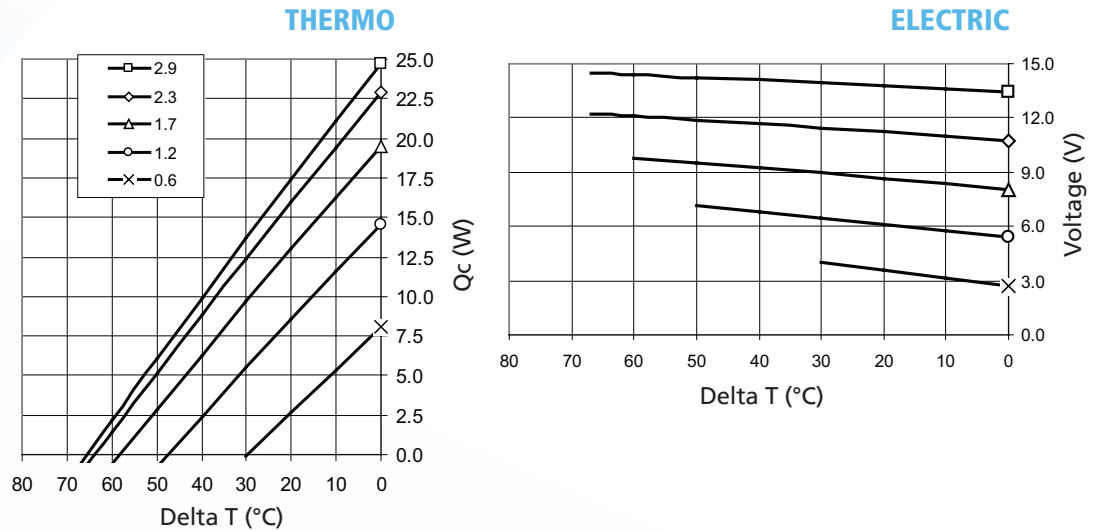

Ceramic Material: Alumina (Al_2O_3)
 Solder Construction: 271°C , Proprietary

OPERATING TIPS

- Max Operating Temperature: 175°C
- Do not exceed I_{max} or V_{max} when operating module
- Reference assembly guidelines for recommended installation

THR-DS-HT3,12,F2,3030 0509

Any information furnished by Laird Technologies and its agents is believed to be accurate and reliable. Responsibility for the use and application of Laird Technologies materials rests with the end user since Laird Technologies and its agents cannot be aware of all potential uses. Laird Technologies makes no warranties as to the fitness, merchantability, or suitability of any Laird Technologies materials or products for any specific or general uses. Laird Technologies shall not be liable for incidental or consequential damages of any kind. All Laird Technologies products are sold pursuant to the Laird Technologies terms and conditions of sale in effect from time to time, a copy of which will be furnished upon request. For further information please visit our website at www.lairdtech.com Alternatively contact: sales@lairdtech.com. Bluetooth® is a trademark owned by Bluetooth SIG, Inc., USA and licensed to Laird Technologies.