

## DETAILS

<b>Product Number</b>	CA13307_LAURA-O-WAS-PIN
<b>Family</b>	Laura
<b>Type</b>	Assembly
<b>Color</b>	white
<b>Diameter</b>	21,6 x 21,6 mm
<b>Height</b>	13,1 mm
<b>Style</b>	square
<b>Optic Material</b>	PMMA
<b>Holder Material</b>	
<b>Fastening</b>	pin, tape
<b>Status</b>	production ready
<b>ROHS Compliant</b>	Yes
<b>Date Updated</b>	3/06/2013



## OPTICAL PROPERTIES

LED	Viewing Angle	Light Beam	Efficiency	cd/lm	Connector
XP-G	Asymmetric degOval		84 %	2.600	-
XP-E	Asymmetric degOval		84 %	3.000	-
XB-D	Asymmetric degOval		83 %	2.500	-
XT-E	Asymmetric degOval		83 %	2.500	-
XP-G2	asymmetric degOval		83 %	2.900	-
LUXEON Rebel	Asymmetric degOval		87 %	3.100	-
LUXEON A	Asymmetric degOval		84 %	2.300	-
NCSxx19A	Asymmetric degOval		83 %	2.500	-
NVSxx19A	Asymmetric degOval		82 %	2.200	-
NCSxx19B	asymmetric degOval		82 %	3.000	-
Oslon Square EC	Asymmetric degOval		84 %	2.400	-
Oslon SSL 80	Asymmetric degOval		83 %	2.600	-
Oslon SSL 150	Asymmetric degOval		84 %	3.100	-

D

C

B

A

4

4

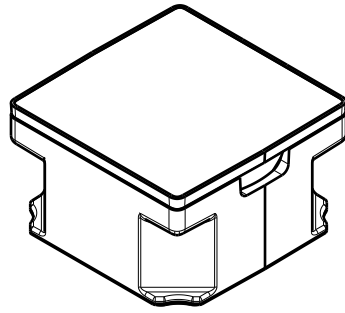

Isometric view

3

3

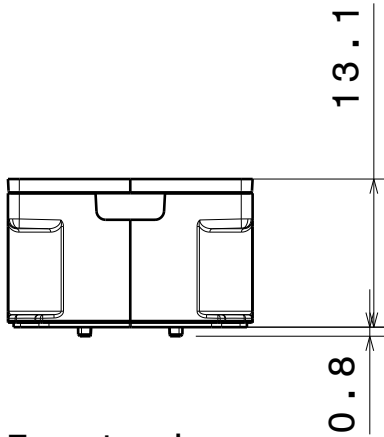

Front view

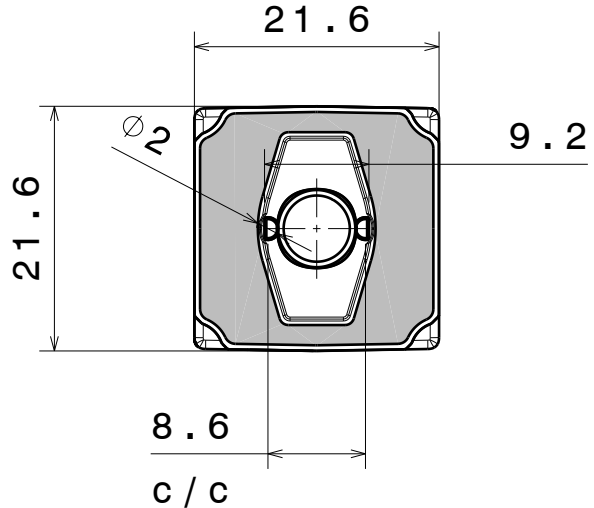

Bottom view

2

2

Tolerances if not otherwise shown  
 According to DIN ISO 2768-1  
 Linear measures:  
 Up to 30mm class M, otherwise class C.  
 According to DIN ISO 2768-2  
 Form and position: class L

**LEDiL** Ledil Oy  
 Salorankatu 10  
 FIN 24240 SALO  
 Finland

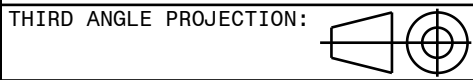

DRAWING TITLE  
**LAURA-WAS-PIN-TAPE**

This drawing is the property of LEDiL Oy. It may not be reproduced, copied or communicated without a written agreement with LEDiL Oy."

SIZE	PART NUMBER		
A4	-		
SCALE	3:2	WEIGHT	-
		SHEET	1/1

1

1

D

A

Luminaire: Ledil Oy CP13308&CA13307\_LAURA-O-WAS Eff. 84%  
Lamps: 1 x Cree XP-G 70lm@250mA

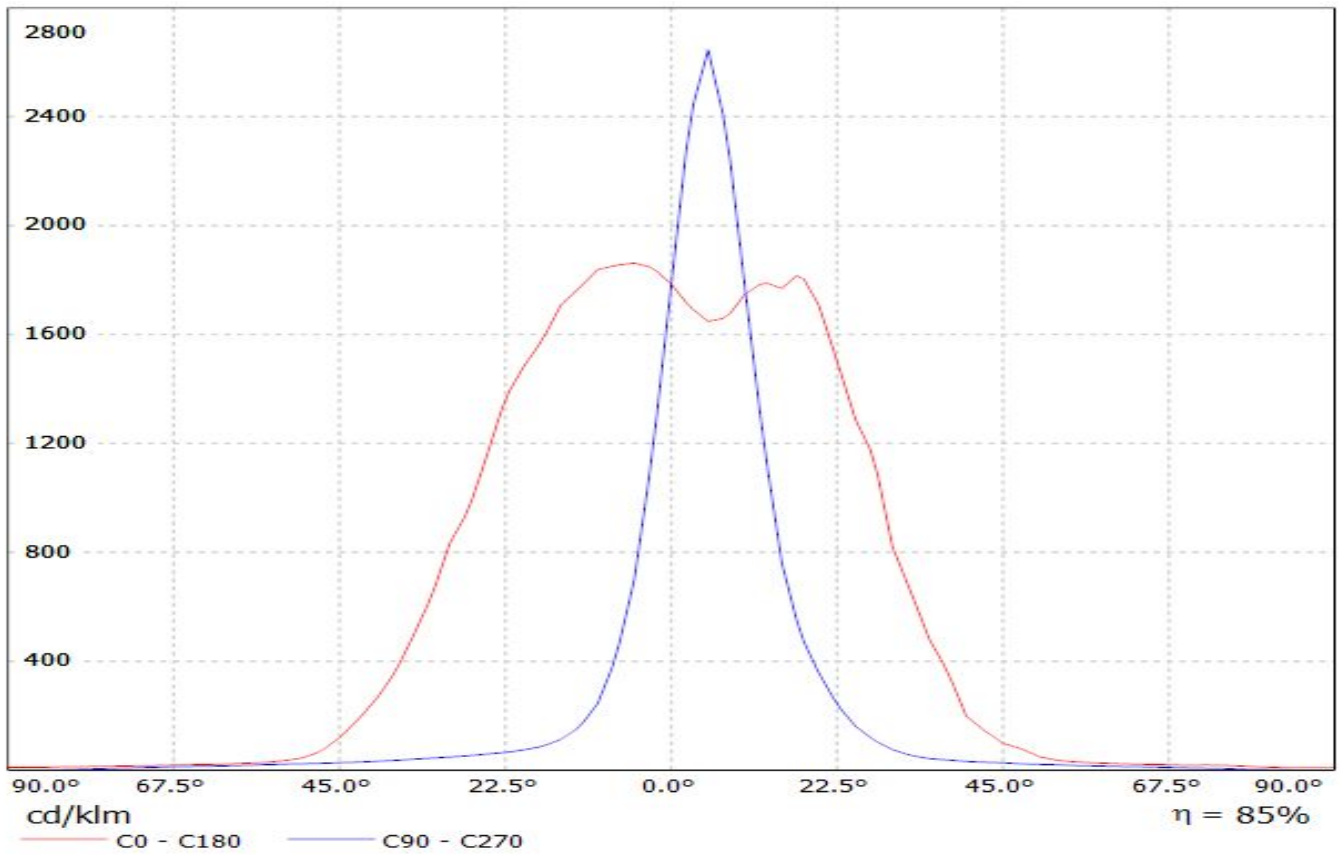

Luminaire: Ledil Oy CP13308&CA13307\_LAURA-O-WAS (Cree XP-E 70lm @ 250mA) Efficiency=84%  
Lamps: 1 x Cree XP-E 70lm @ 250mA

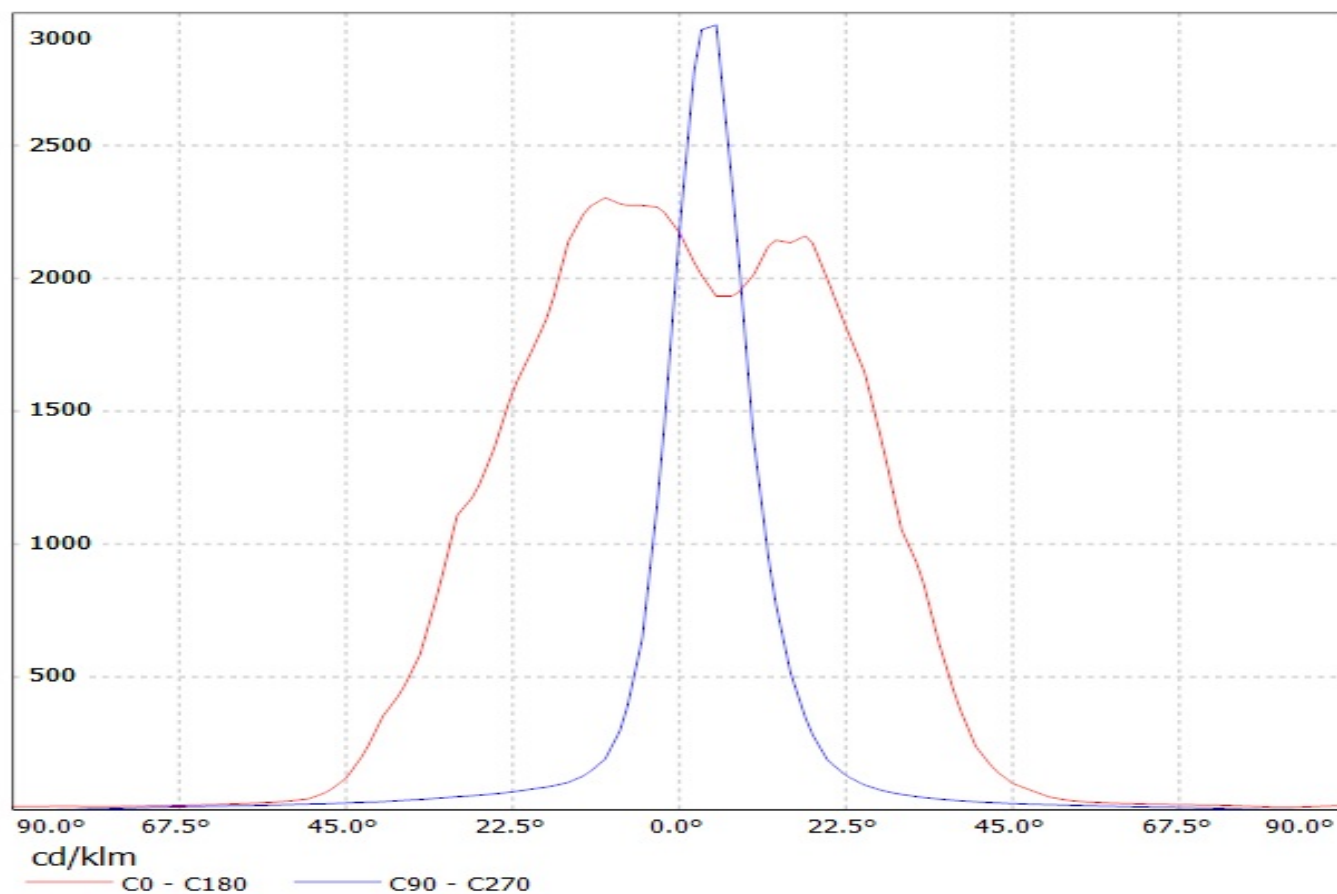

Luminaire: Ledil Oy CP13311&CA13312\_LAURA-SS-WAS (Cree XB-D 94lm @ 250mA) Efficiency=83%  
Lamps: 1 x Cree XB-D 94lm @ 250mA

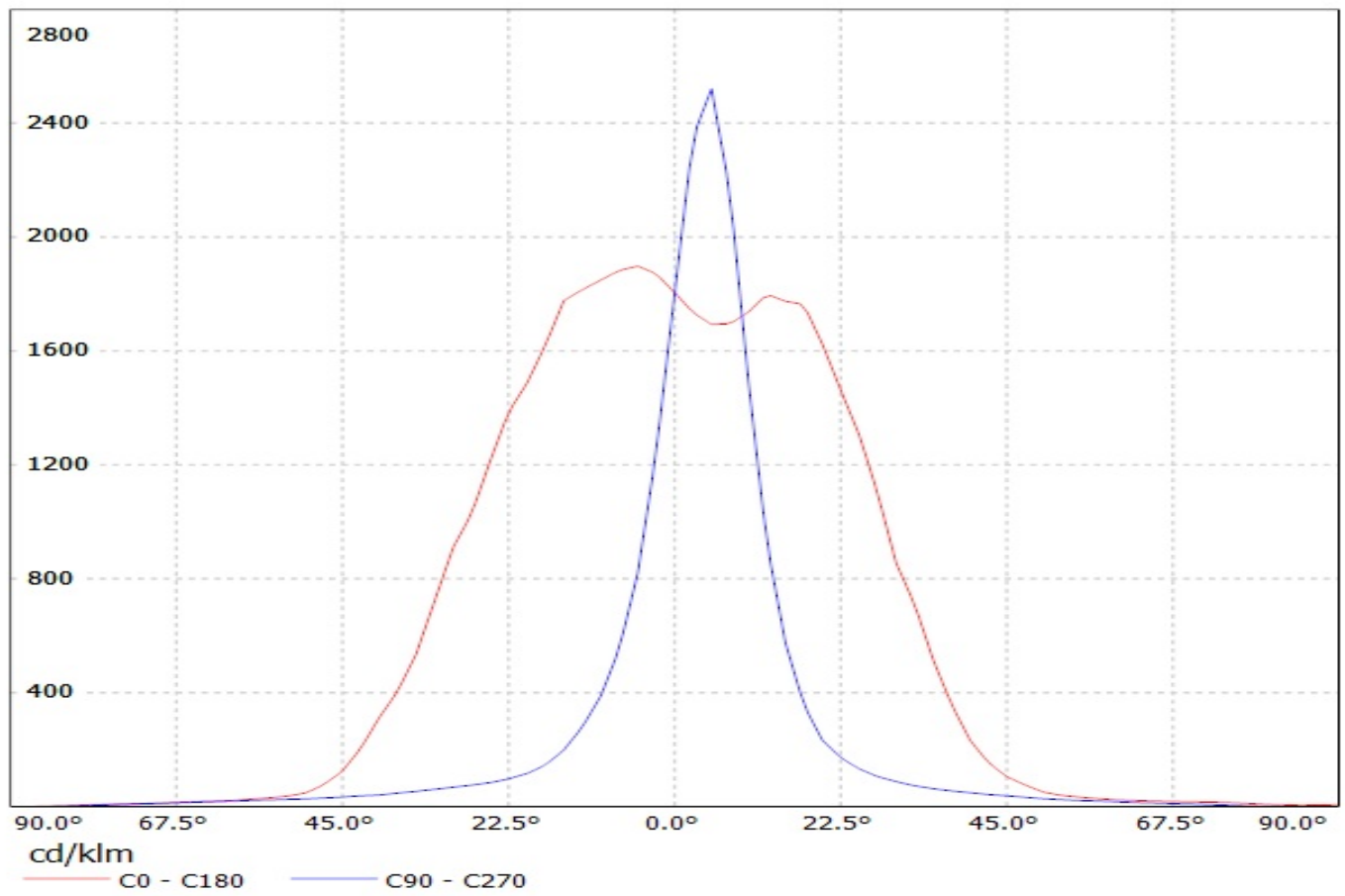

Luminaire: Ledil Oy CP13308&CA13307\_LAURA-O-WAS (Cree XT-E 100lm @ 250mA) Efficiency=83%  
Lamps: 1 x Cree XT-E 100lm @ 250mA

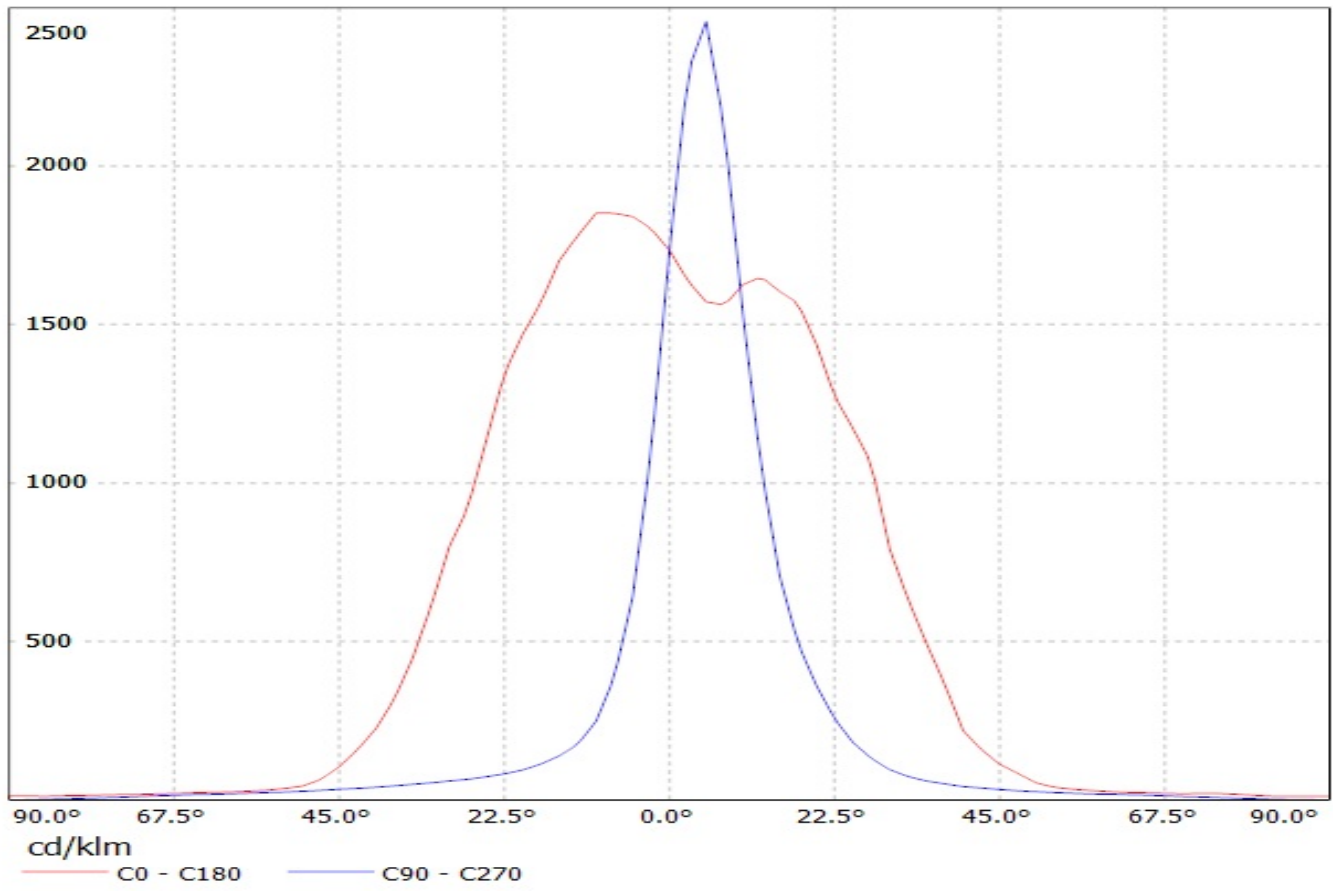

Luminaire: LEDil Oy CA13307\_LAURA-O-WAS-PIN\_(XP-G2) Efficiency=83%  
Lamps: 1 x Cree XP-G2 (XPGBWT-L1-0000-00FE4) 101lm @ 250mA CCT=6600K P=0.7W I=250mA

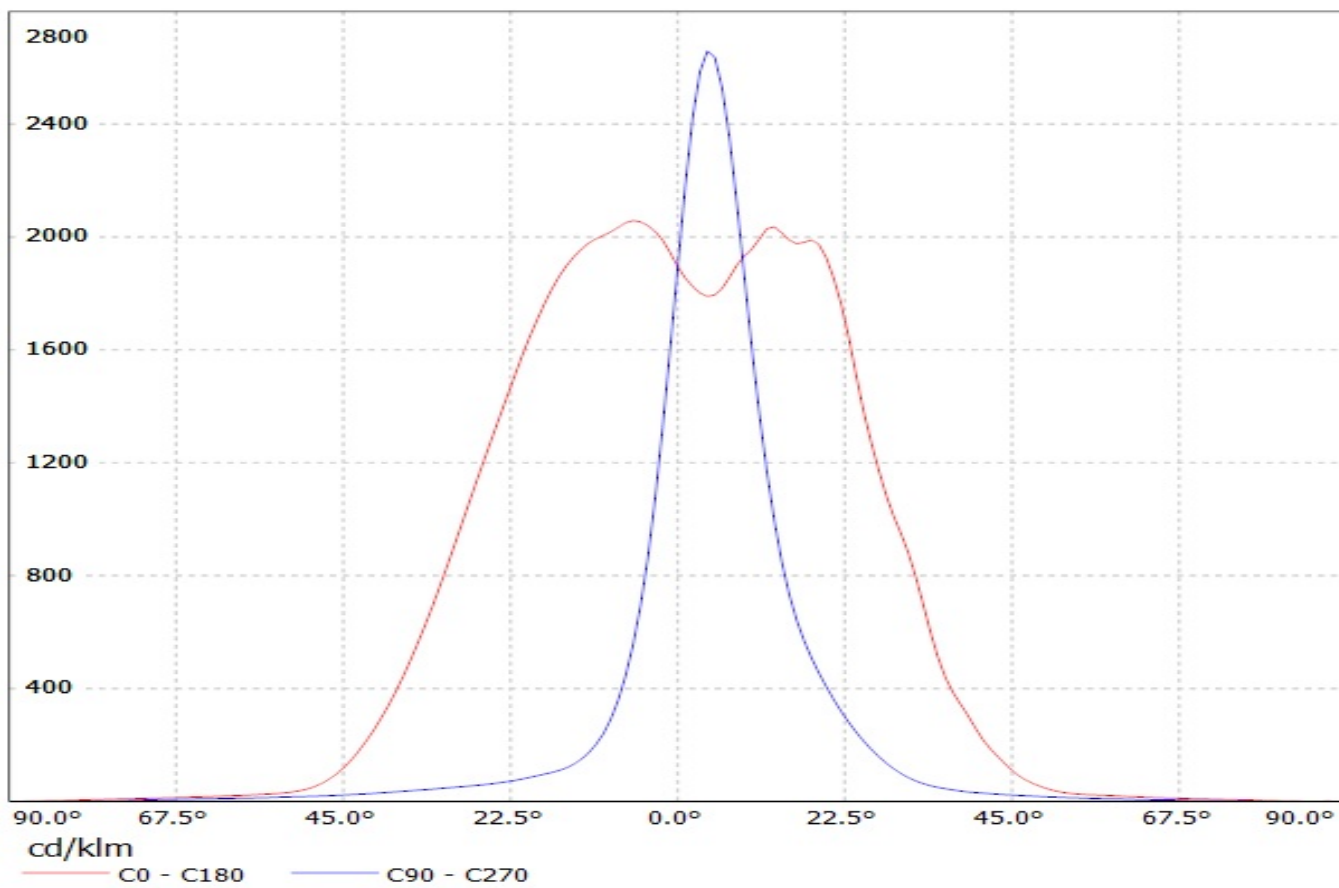

Luminaire: Ledil Oy CP13308\_LAURA-O-WAS (Luxeon Rebel 80lm @ 250mA) Efficiency=87%  
Lamps: 1 x Luxeon Rebel 80lm @ 250mA

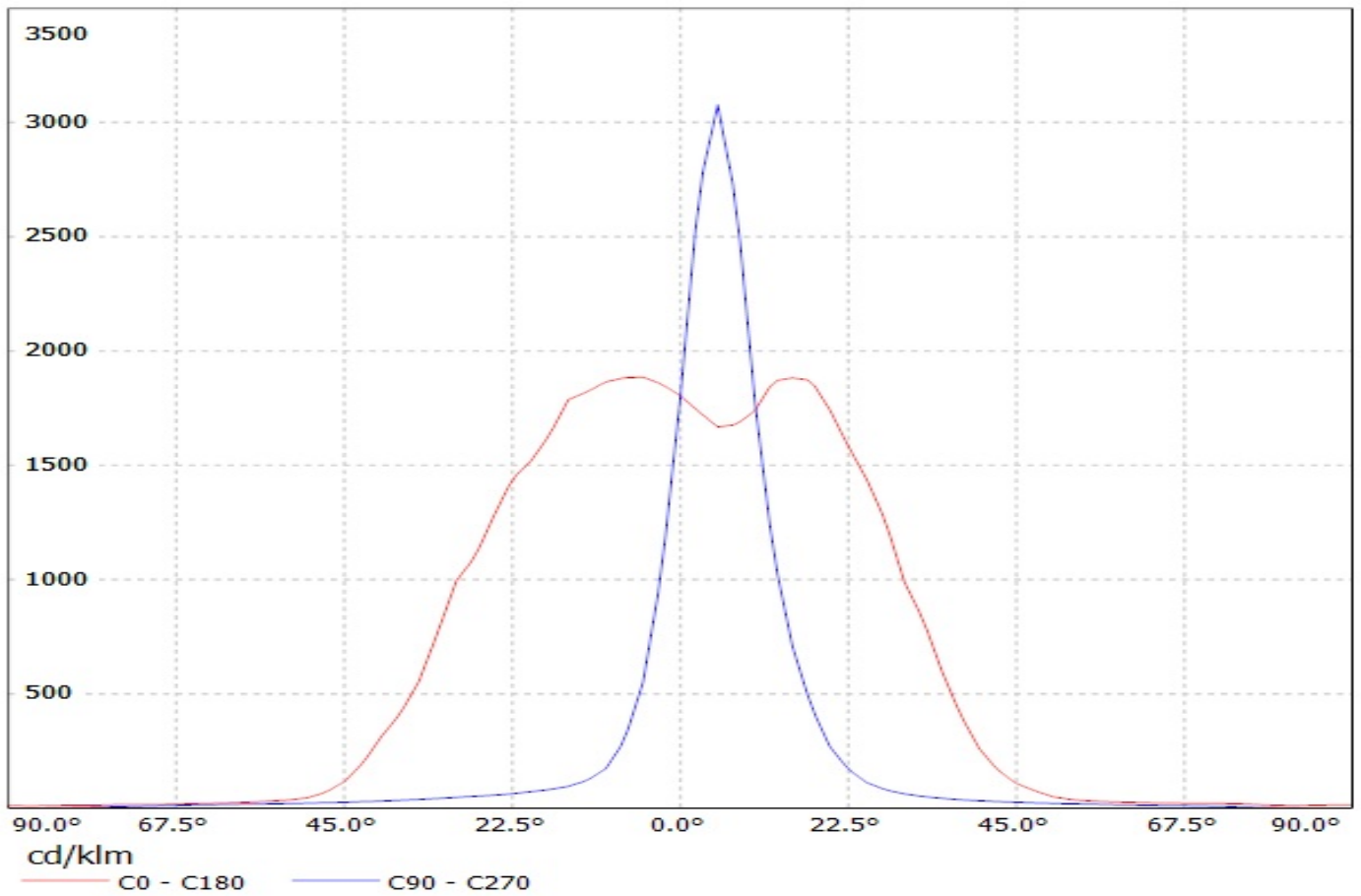



Luminaire: Ledil Oy CP13308&CA13307\_LAURA-O-WAS (Luxeon A 64lm @ 250mA) Efficiency=84%  
Lamps: 1 x Luxeon A 64lm @ 250mA

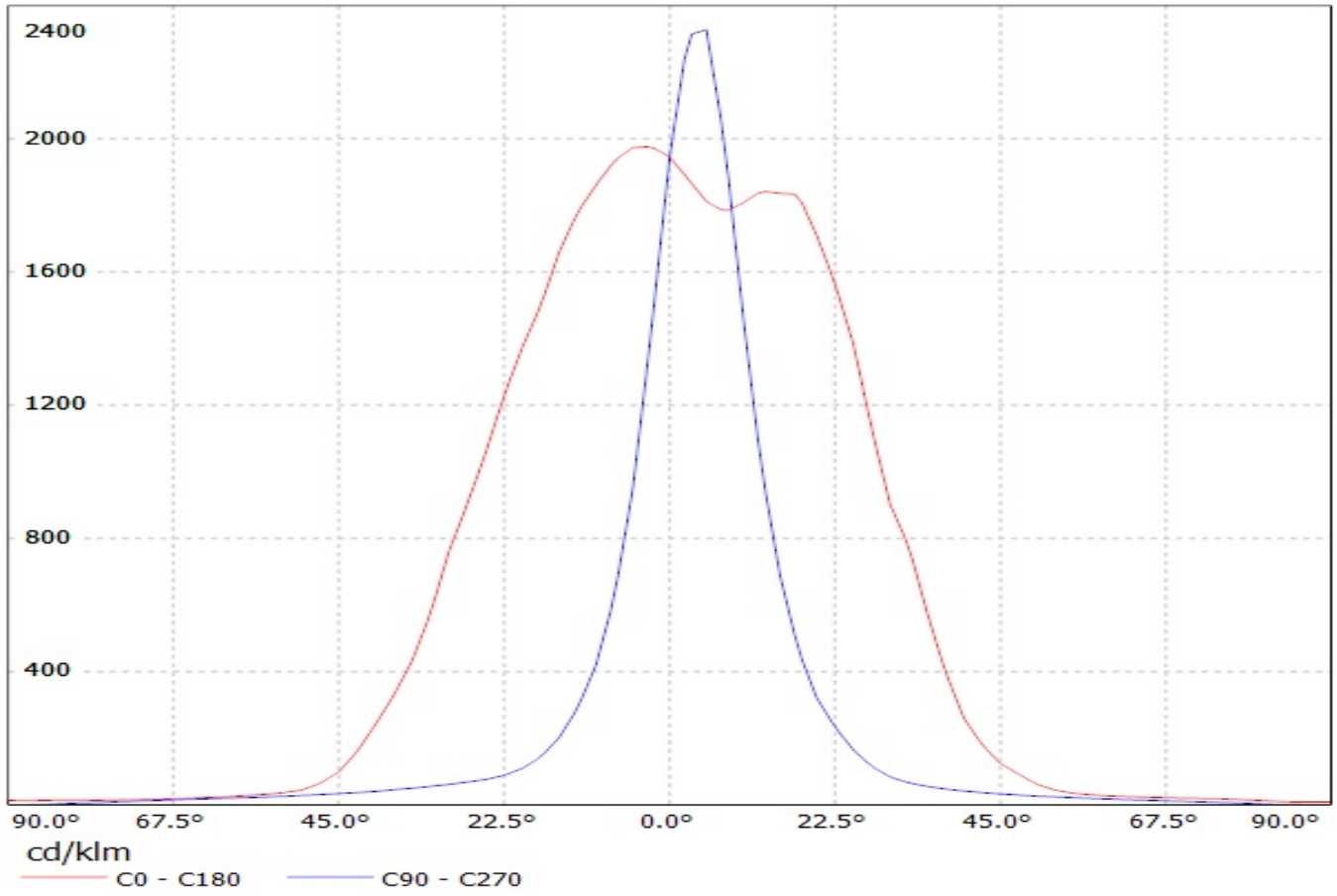

Luminaire: Ledil Oy CP13308&CA13307\_LAURA-O-WAS (Nichia NCS19 95lm @ 250mA) Efficiency=83%  
Lamps: 1 x Nichia NCS19 95lm @ 250mA

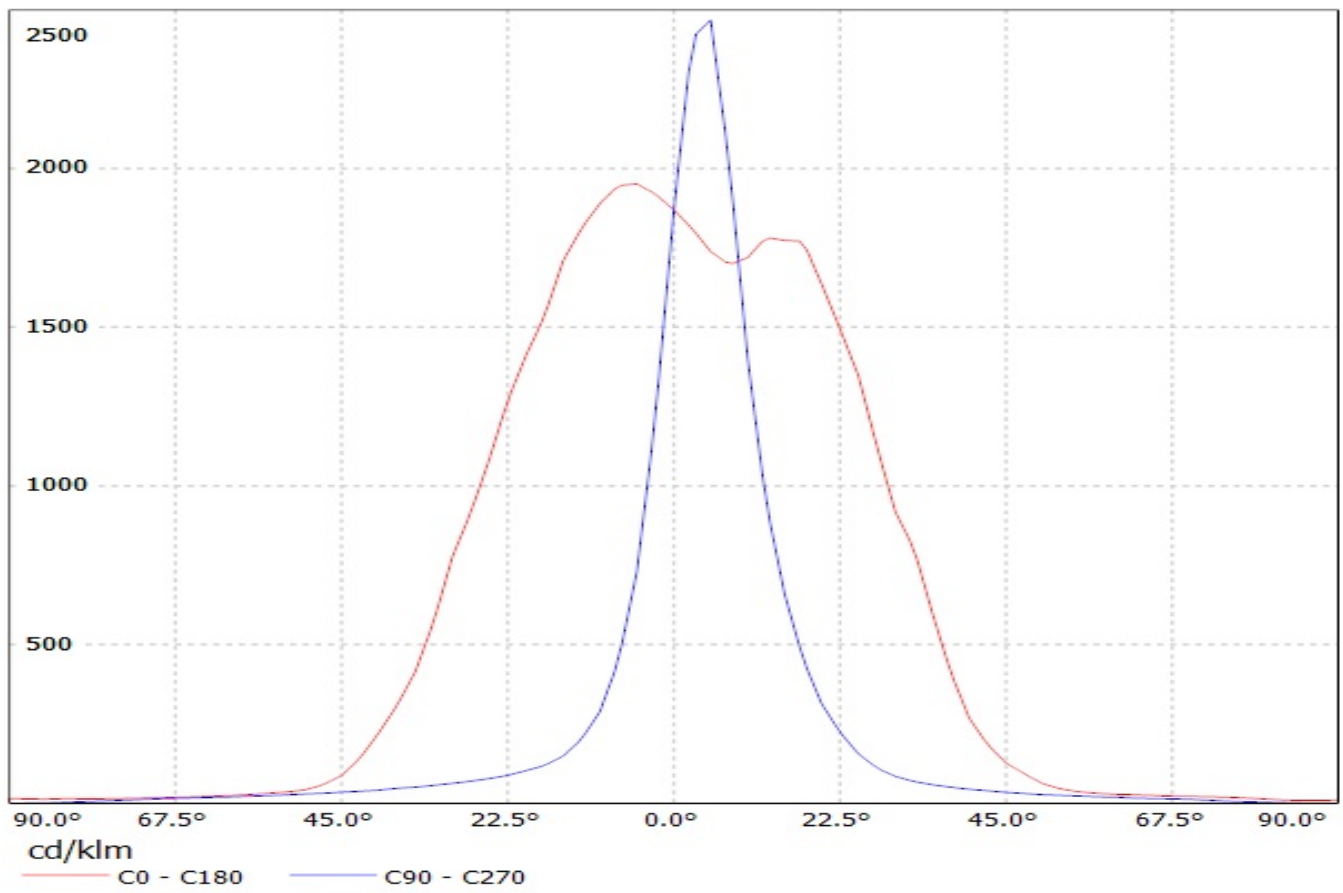

Luminaire: Ledil Oy CP13308&CA13307\_LAURA-O-WAS (Nichia NVS19lm @ 250mA) Efficiency=82%  
Lamps: 1 x Nichia NVS19lm @ 250mA

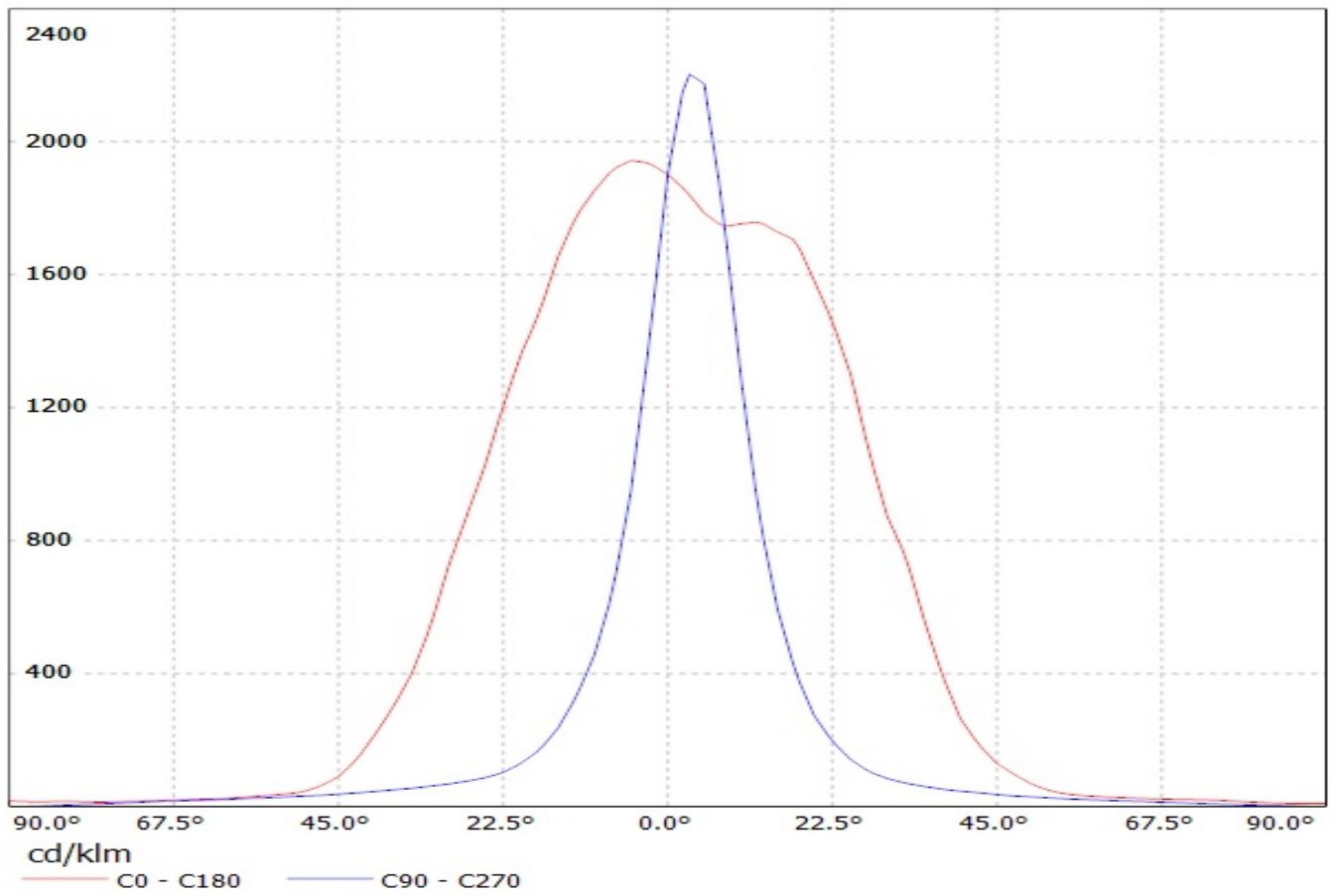

Luminaire: LEDil Oy CA13307\_LAURA-O-WAS-PIN\_(NCSxx19B) Efficiency=82%  
Lamps: 1 x Nichia NCSxx19B (NCSL119E) 90.5lm @ 250mA CCT=3300K P=0.8W I=250mA

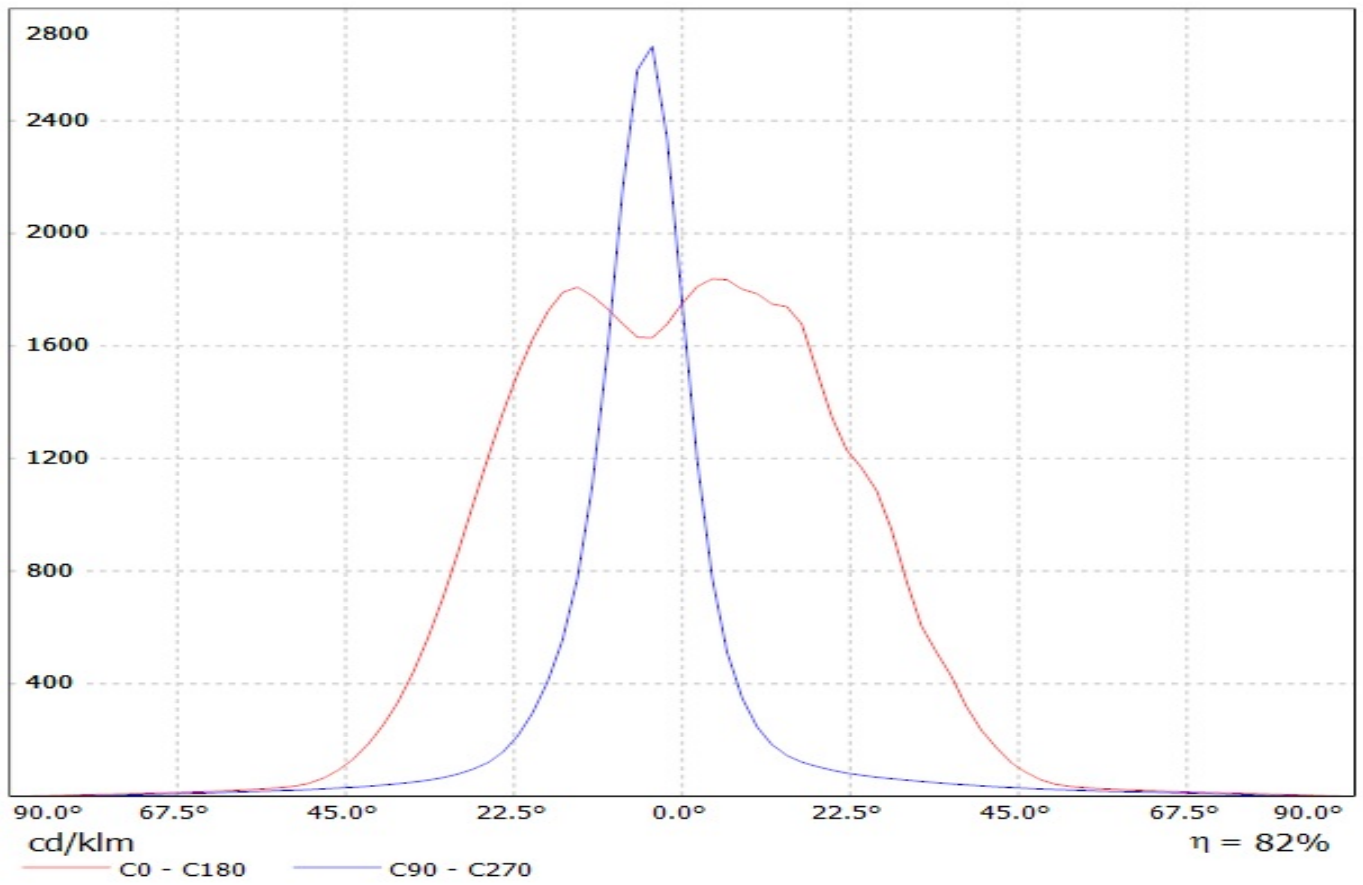

Luminaire: Ledil Oy CP13308&CA13307\_LAURA-O-WAS (Osram Square EC 53lm @ 250mA) Efficiency=84%  
Lamps: 1 x Osram Square EC 53lm @ 250mA

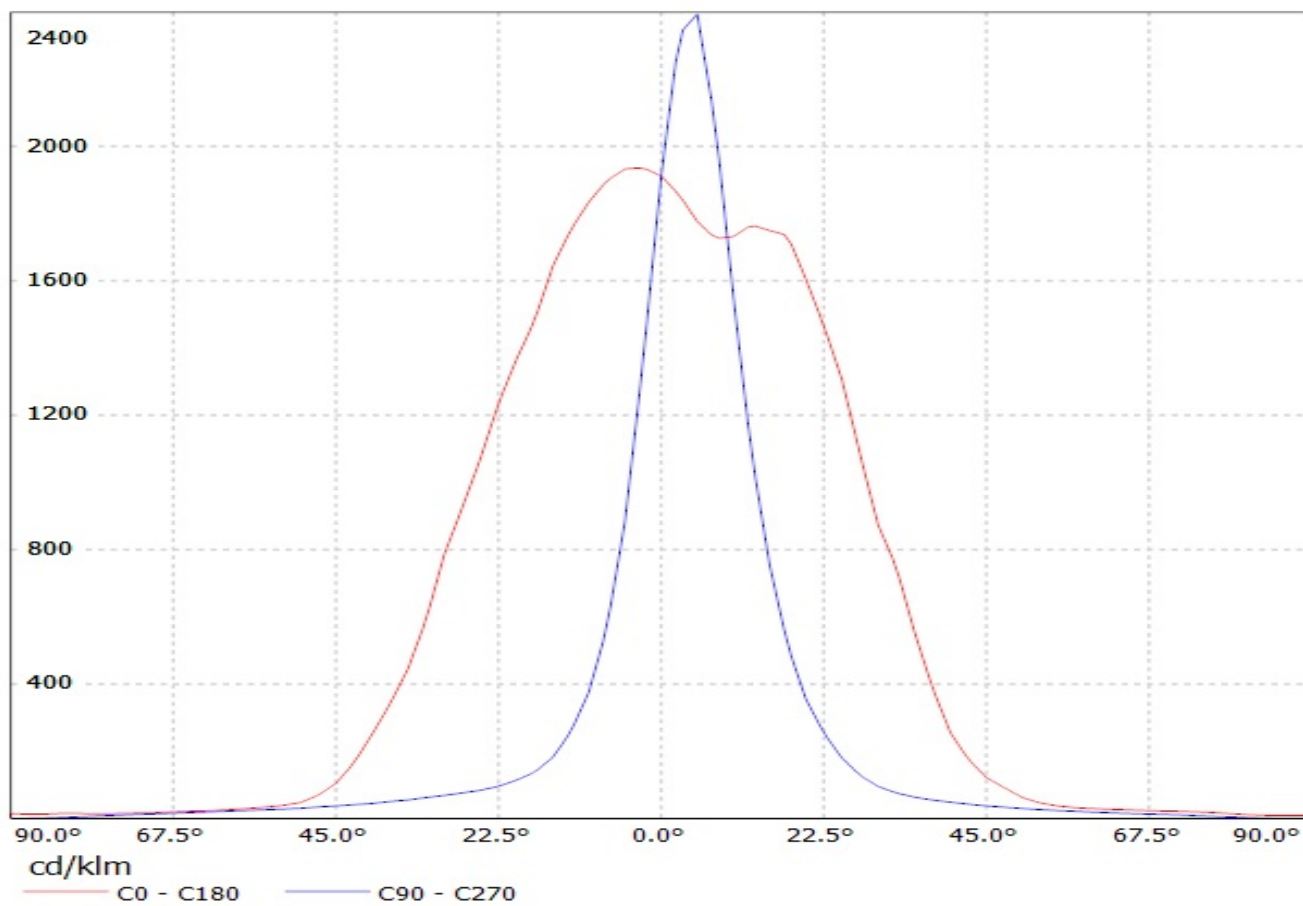

Luminaire: Ledil Oy CP13308&CA13307\_LAURA-O-WAS (Osram Oslon 80deg 79lm @ 250mA) Efficiency=83%  
Lamps: 1 x Osram Oslon 80deg 79lm @ 250mA

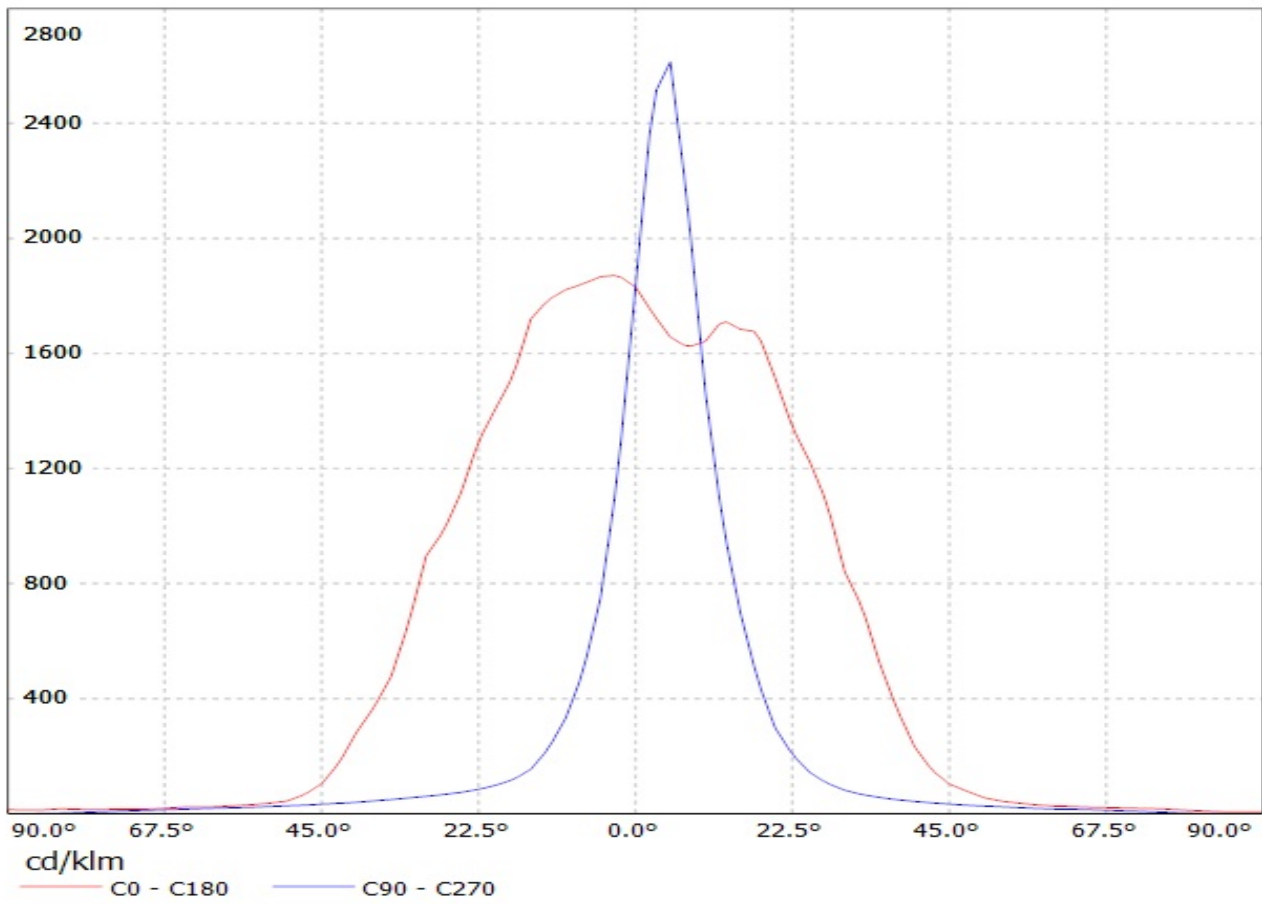

Luminaire: Ledil Oy CP13308&CA13307\_LAURA-O-WAS-OSL150 (Osram oslon 150deg 95lm @ 250mA) Efficiency=84%  
Lamps: 1 x Osram oslon 150deg 95lm @ 250mA

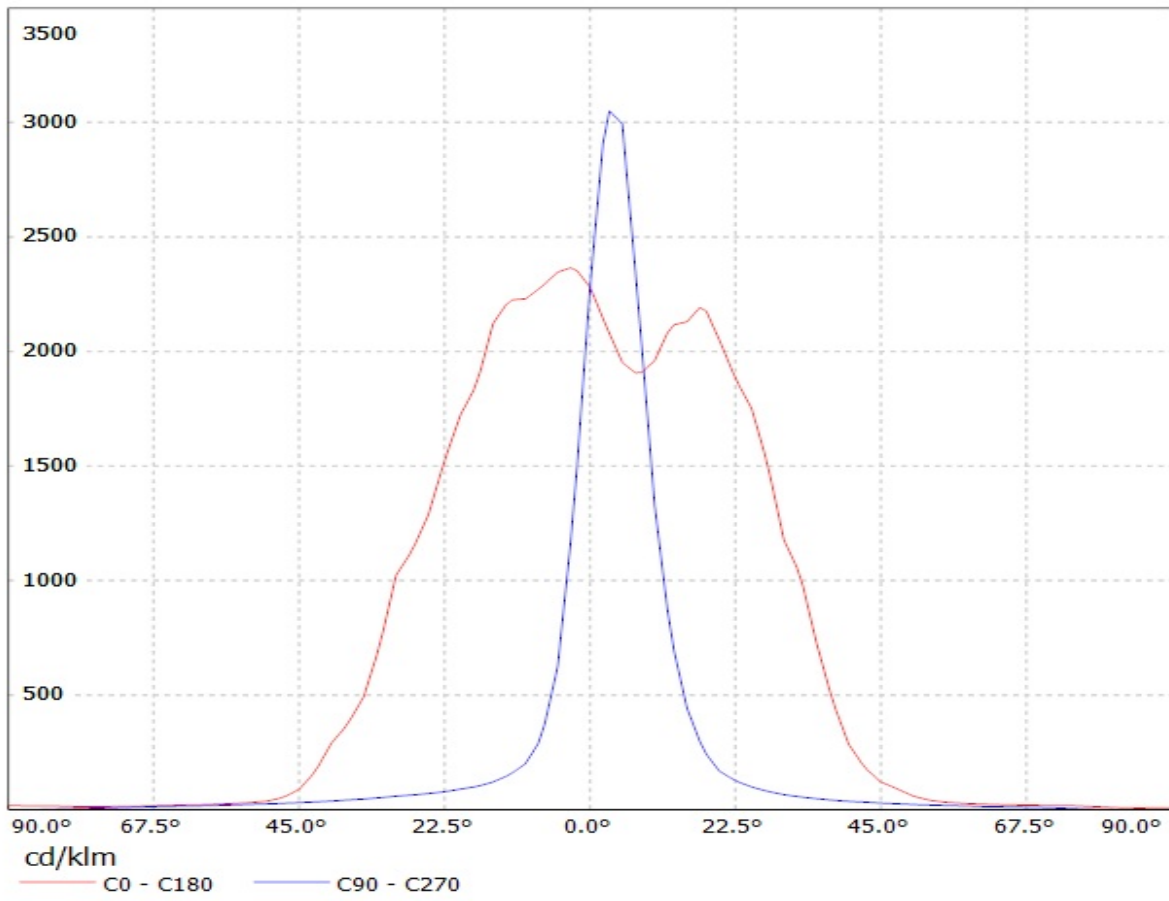

Luminaire: Ledil Oy CP13308&CA13307\_LAURA-O-WAS Eff. 84%  
Lamps: 1 x Cree XP-G 70lm@250mA

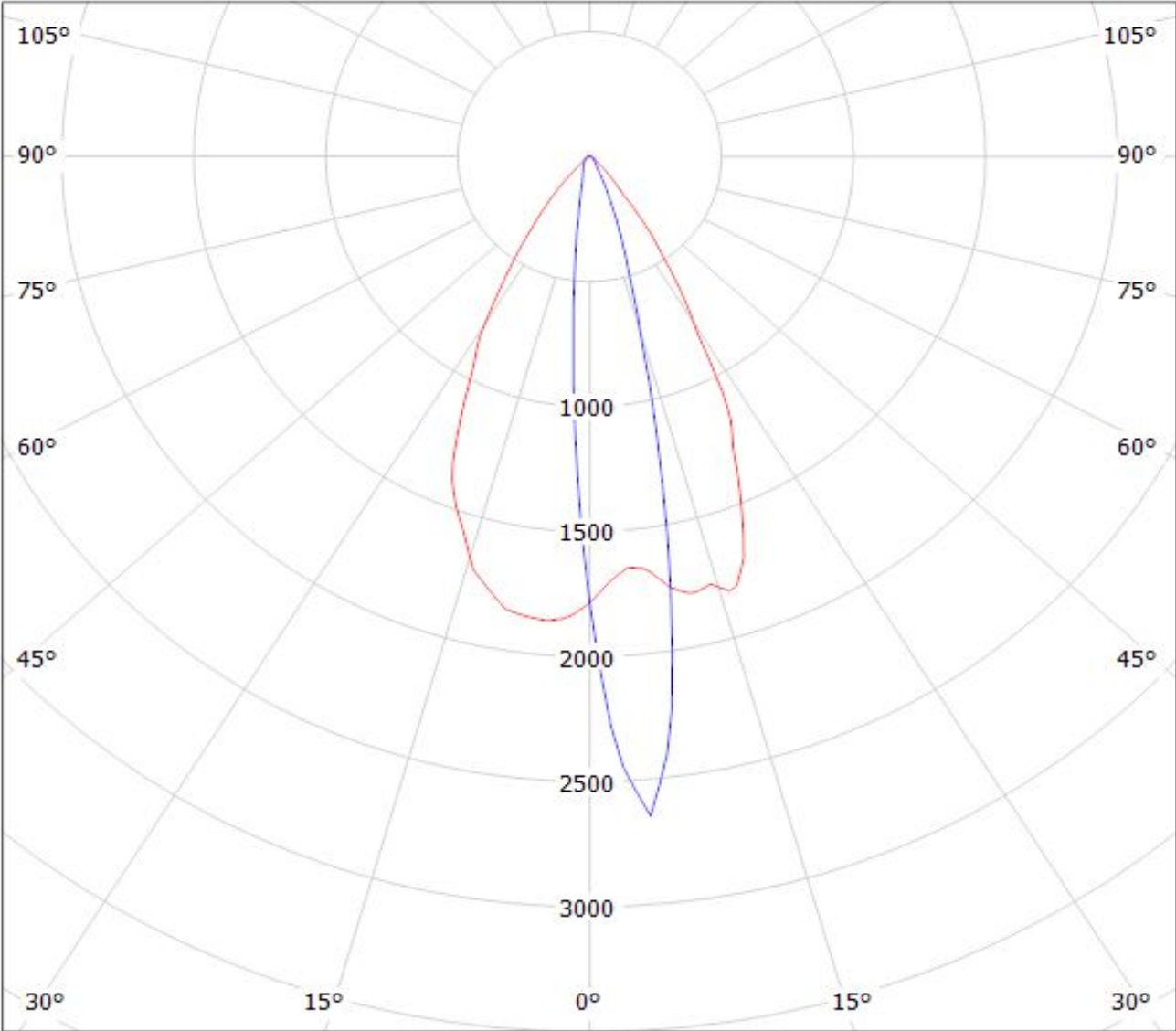

cd/klm

— C0 - C180    — C90 - C270

$\eta = 85\%$



Luminaire: Ledil Oy CP13308&CA13307\_LAURA-O-WAS (Cree XP-E 70lm @ 250mA) Efficiency=84%  
Lamps: 1 x Cree XP-E 70lm @ 250mA

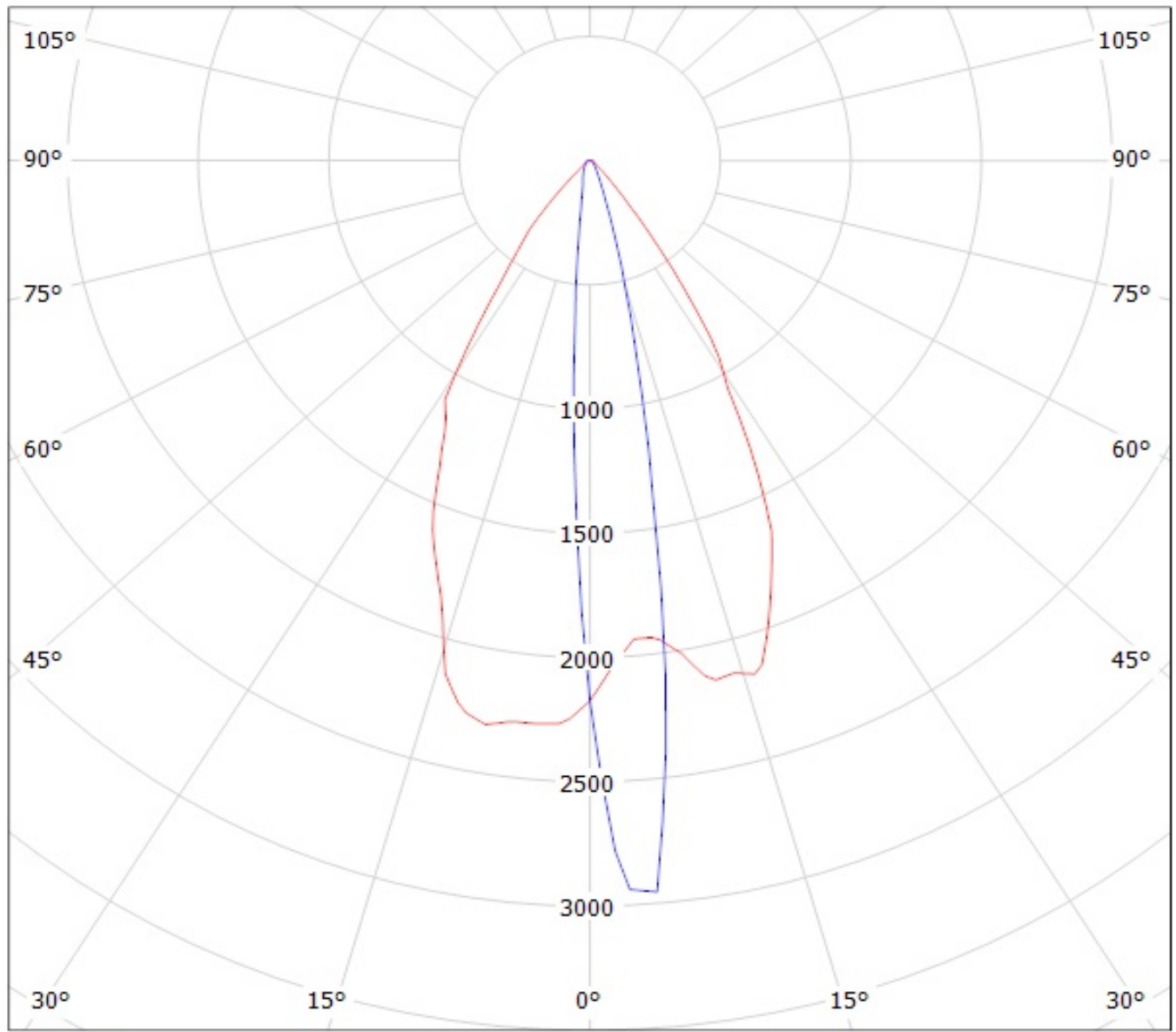

cd/klm  
— C0 - C180    — C90 - C270

Luminaire: Ledil Oy CP13311&CA13312\_LAURA-SS-WAS (Cree XB-D 94lm @ 250mA) Efficiency=83%  
Lamps: 1 x Cree XB-D 94lm @ 250mA

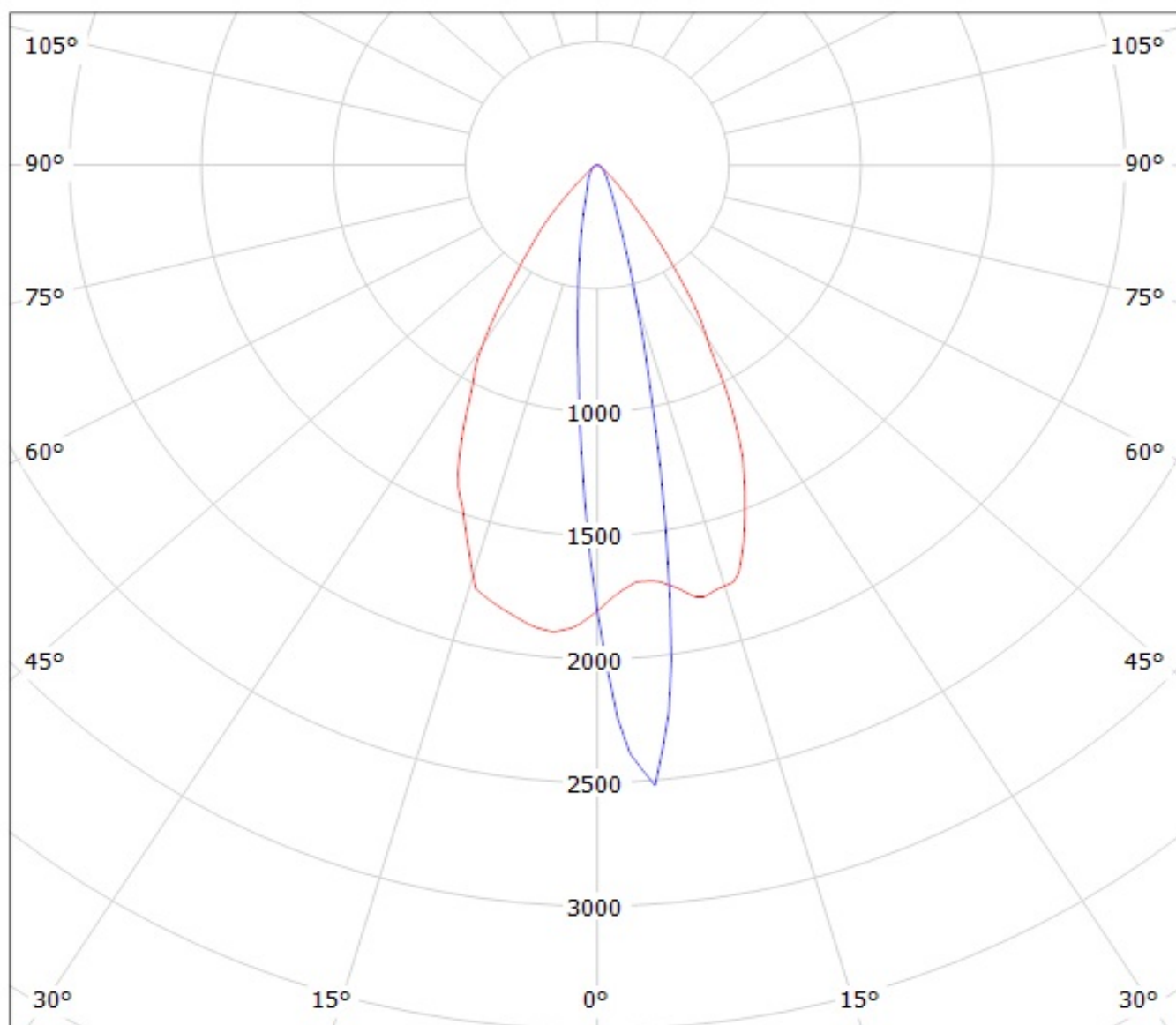

cd/klm

— C0 - C180

— C90 - C270

Luminaire: Ledil Oy CP13308&CA13307\_LAURA-O-WAS (Cree XT-E 100lm @ 250mA) Efficiency=83%  
Lamps: 1 x Cree XT-E 100lm @ 250mA

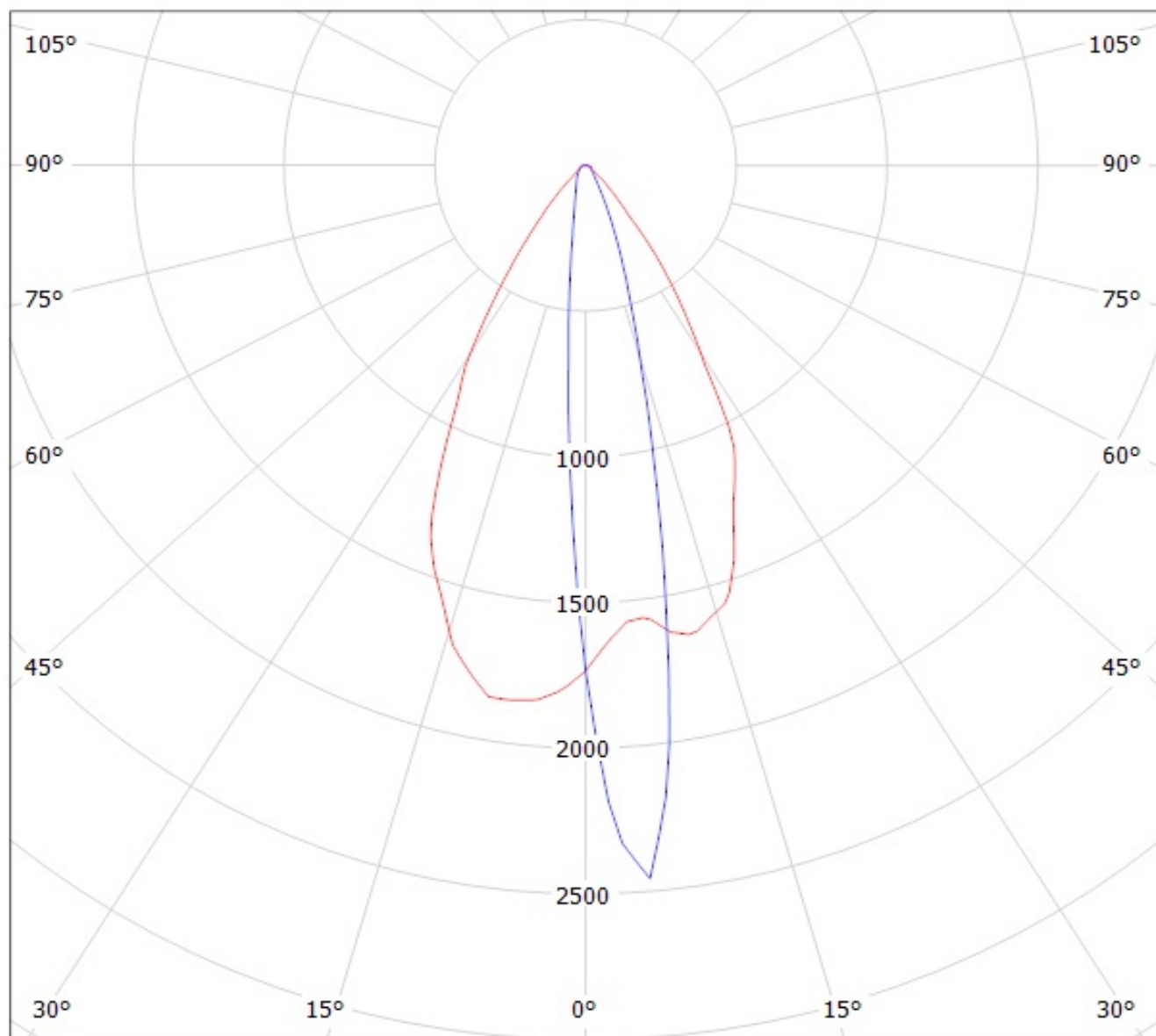

cd/klm

— C0 - C180

— C90 - C270

Luminaire: LEDil Oy CA13307\_LAURA-O-WAS-PIN\_(XP-G2) Efficiency=83%  
Lamps: 1 x Cree XP-G2 (XPGBWTL1-0000-00FE4) 101lm @ 250mA CCT=6600K P=0.7W I=250mA

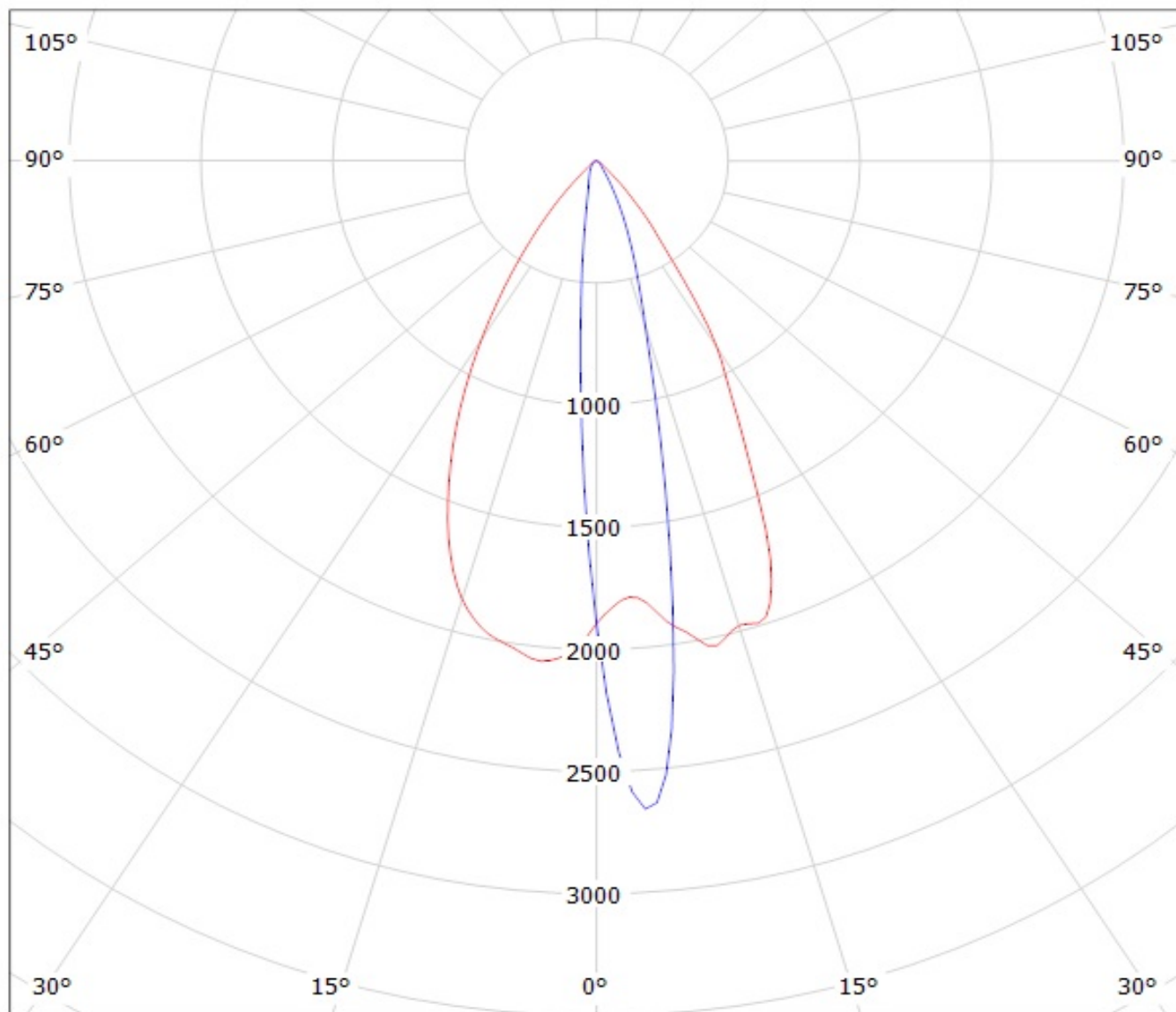

cd/klm

— C0 - C180    — C90 - C270

Luminaire: Ledil Oy CP13308\_LAURA-O-WAS (Luxeon Rebel 80lm @ 250mA) Efficiency=87%  
Lamps: 1 x Luxeon Rebel 80lm @ 250mA

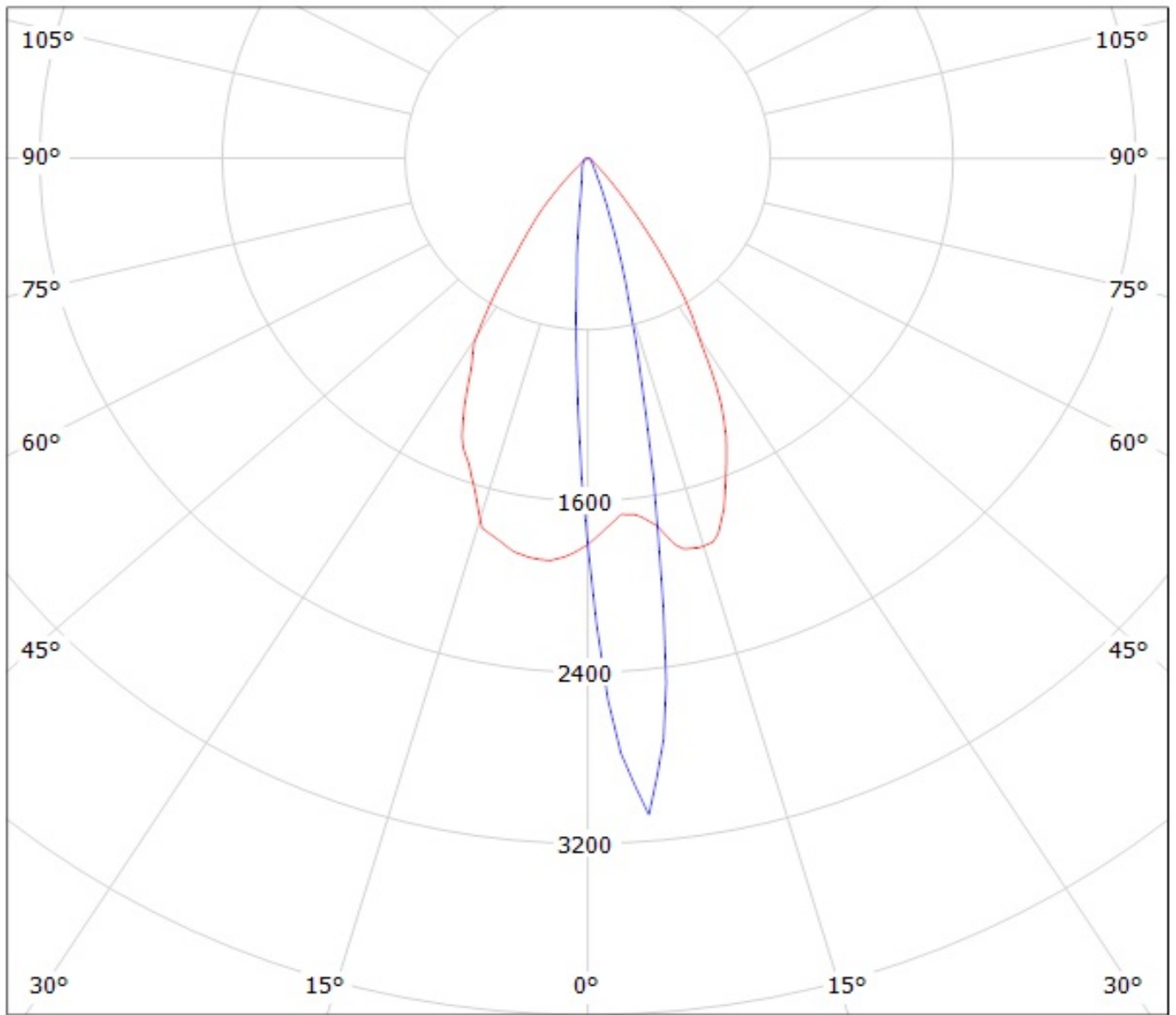

cd/klm  
— C0 - C180    — C90 - C270

Luminaire: Ledil Oy CP13308&CA13307\_LAURA-O-WAS (Luxeon A 64lm @ 250mA) Efficiency=84%  
Lamps: 1 x Luxeon A 64lm @ 250mA

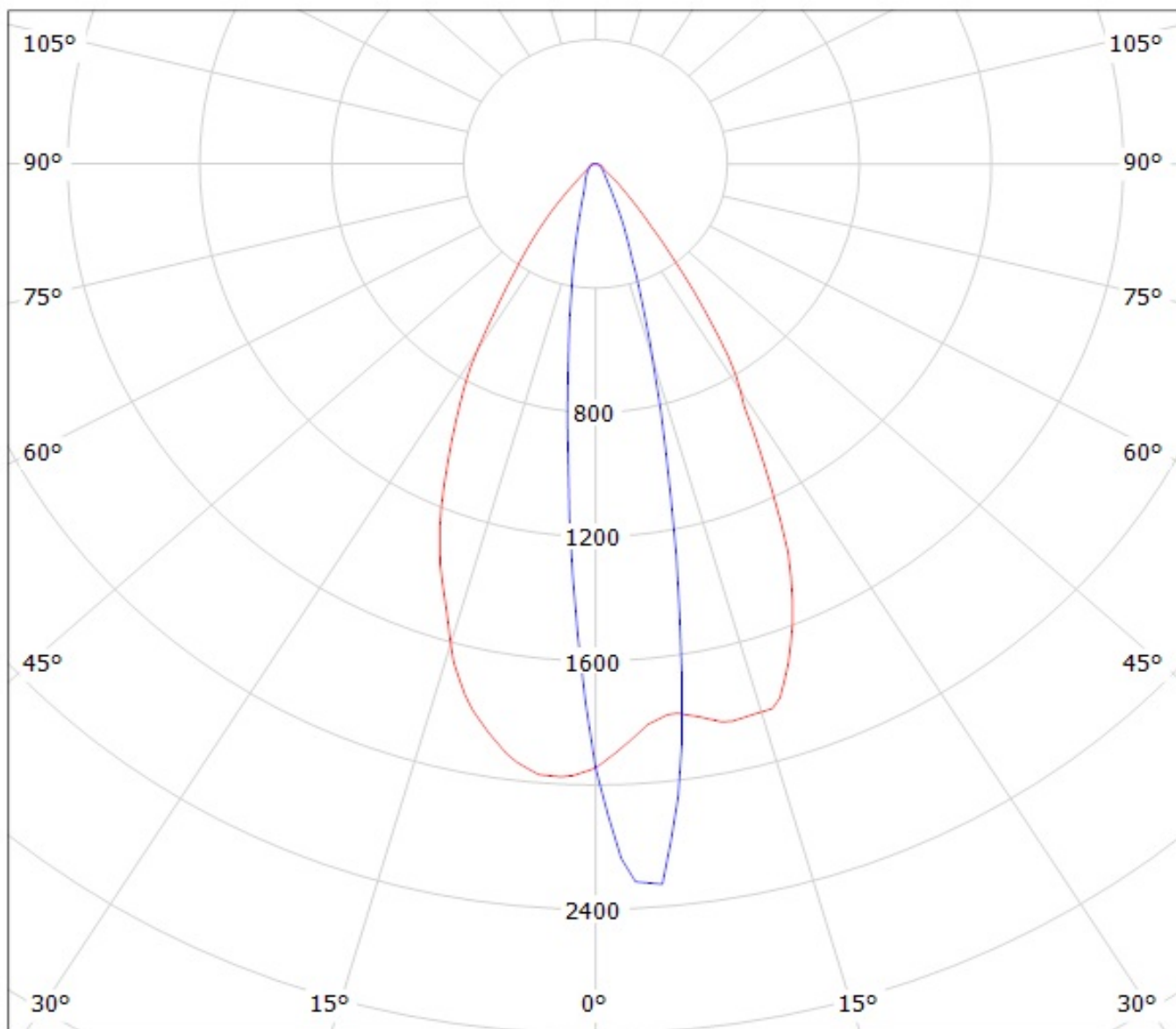

cd/klm

— C0 - C180    — C90 - C270

Luminaire: Ledil Oy CP13308&CA13307\_LAURA-O-WAS (Nichia NCS19 95lm @ 250mA) Efficiency=83%  
Lamps: 1 x Nichia NCS19 95lm @ 250mA

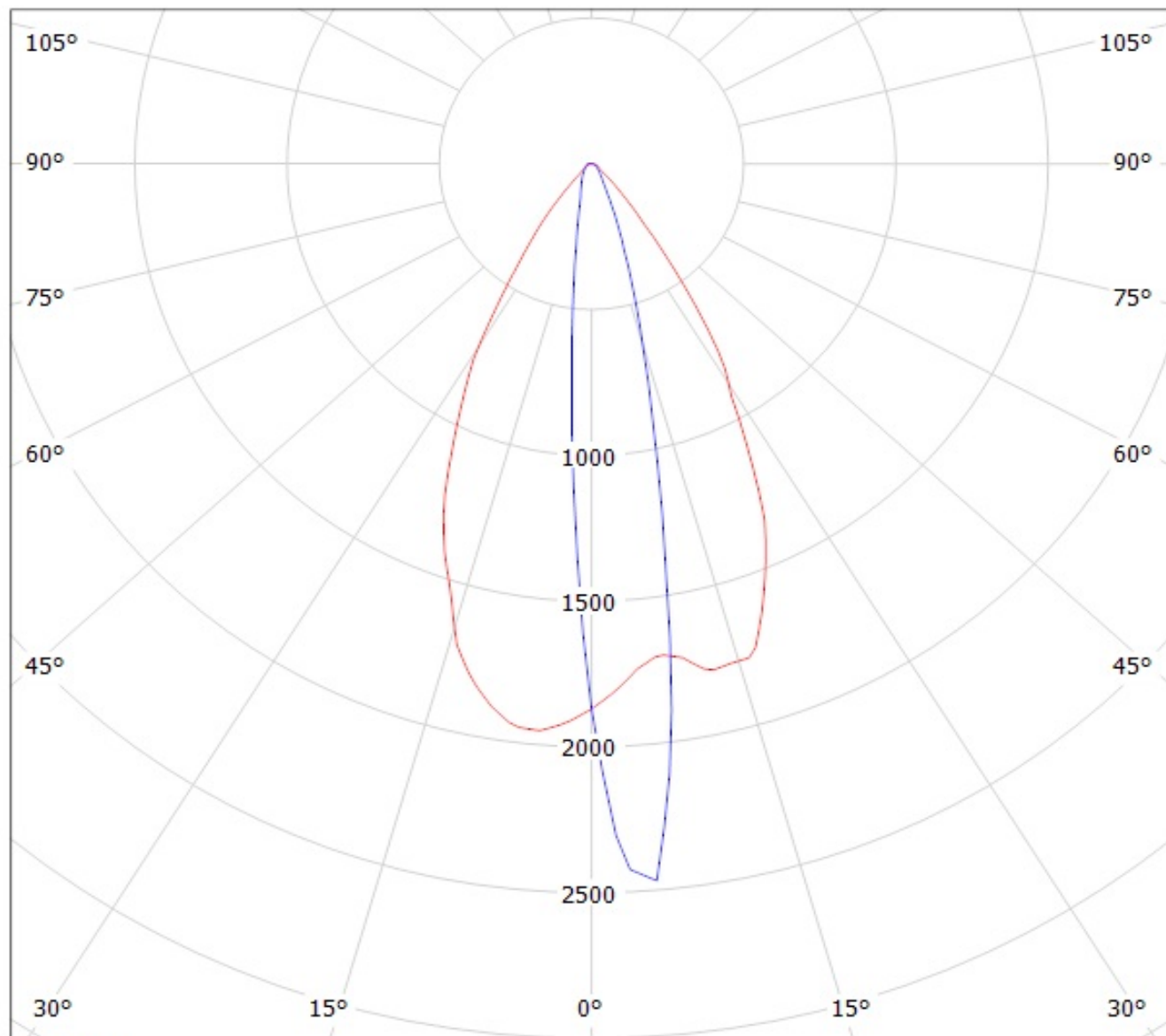

cd/klm

— C0 - C180

— C90 - C270

Luminaire: Ledil Oy CP13308&CA13307\_LAURA-O-WAS (Nichia NVS19lm @ 250mA) Efficiency=82%  
Lamps: 1 x Nichia NVS19lm @ 250mA

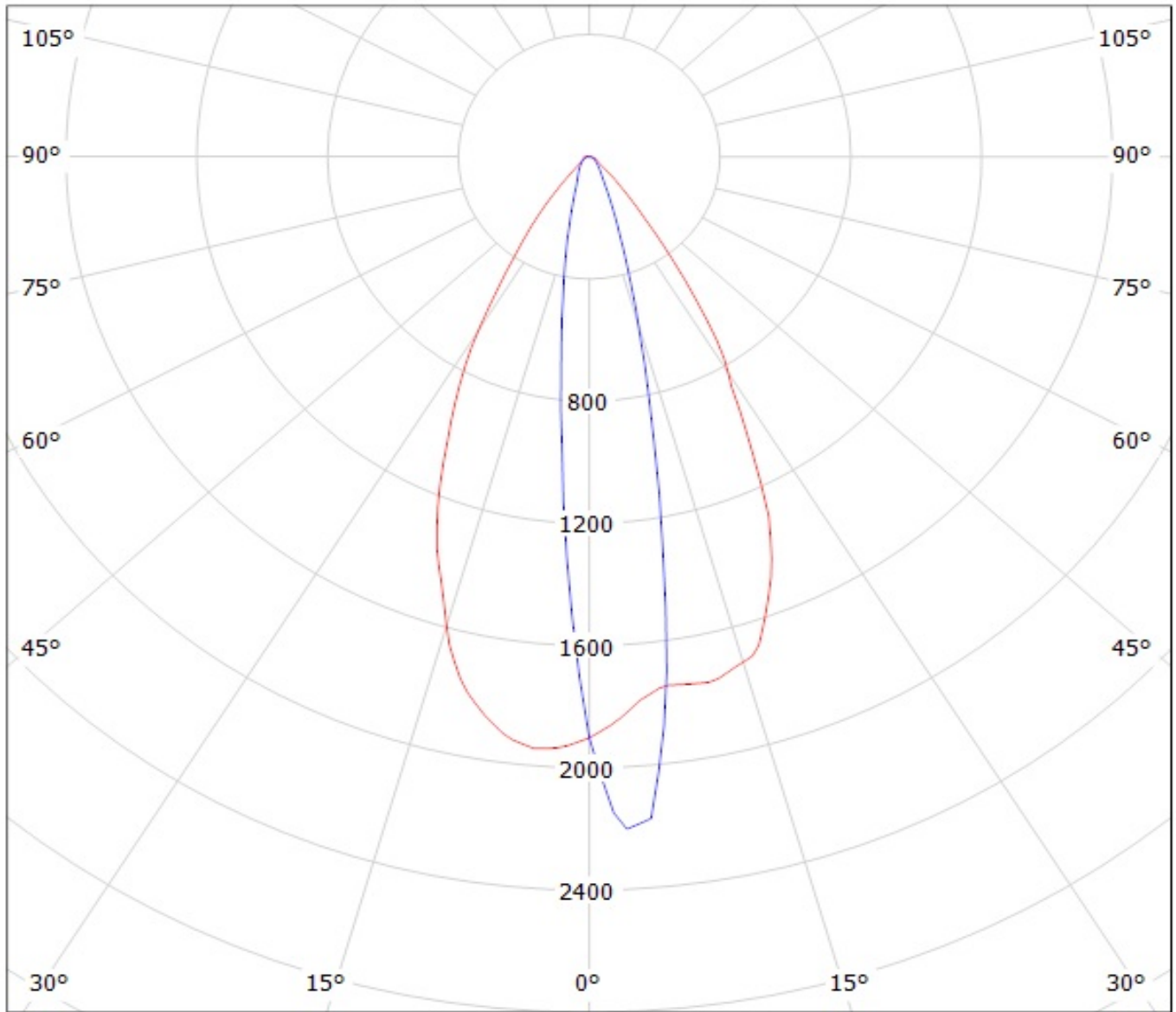

cd/klm

— C0 - C180    — C90 - C270



Luminaire: LEDil Oy CA13307\_LAURA-O-WAS-PIN\_(NCSxx19B) Efficiency=82%  
Lamps: 1 x Nichia NCSxx19B (NCSL119E) 90.5lm @ 250mA CCT=3300K P=0.8W I=250mA

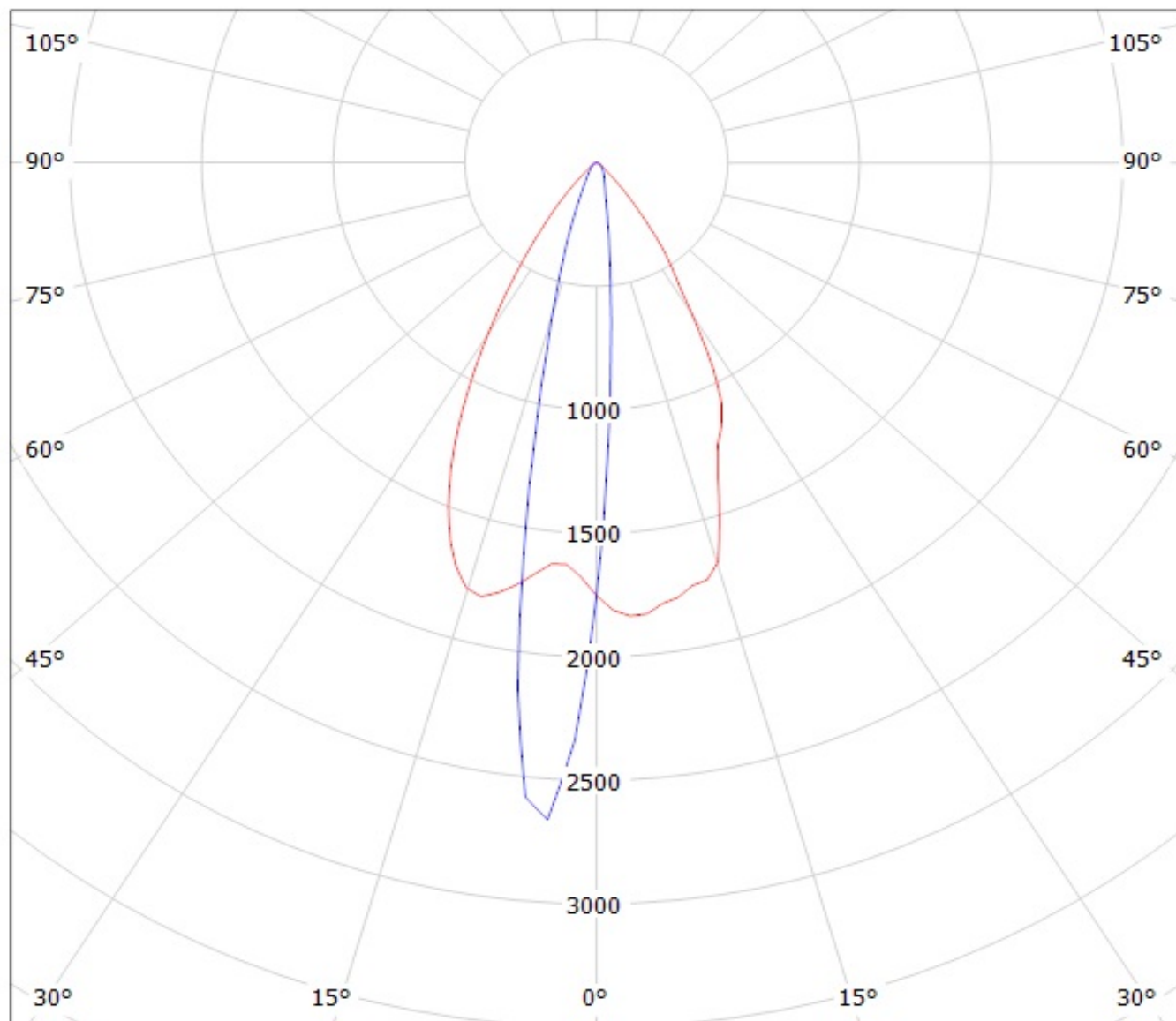

cd/klm

— C0 - C180

— C90 - C270

Luminaire: Ledil Oy CP13308&CA13307\_LAURA-O-WAS (Osram Square EC 53lm @ 250mA) Efficiency=84%  
Lamps: 1 x Osram Square EC 53lm @ 250mA

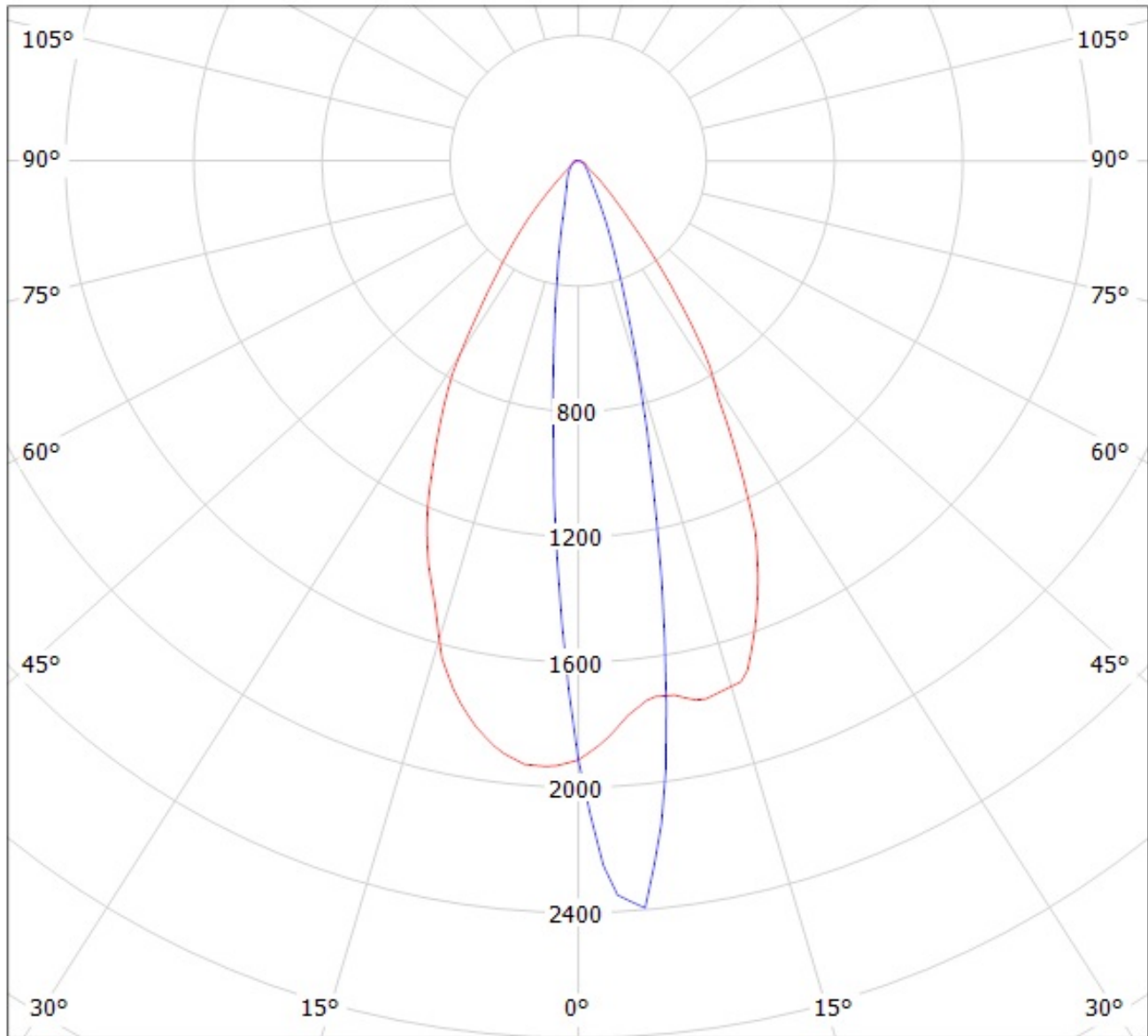

cd/klm

— C0 - C180    — C90 - C270

Luminaire: Ledil Oy CP13308&CA13307\_LAURA-O-WAS (Osram Oslon 80deg 79lm @ 250mA) Efficiency=83%  
Lamps: 1 x Osram Oslon 80deg 79lm @ 250mA

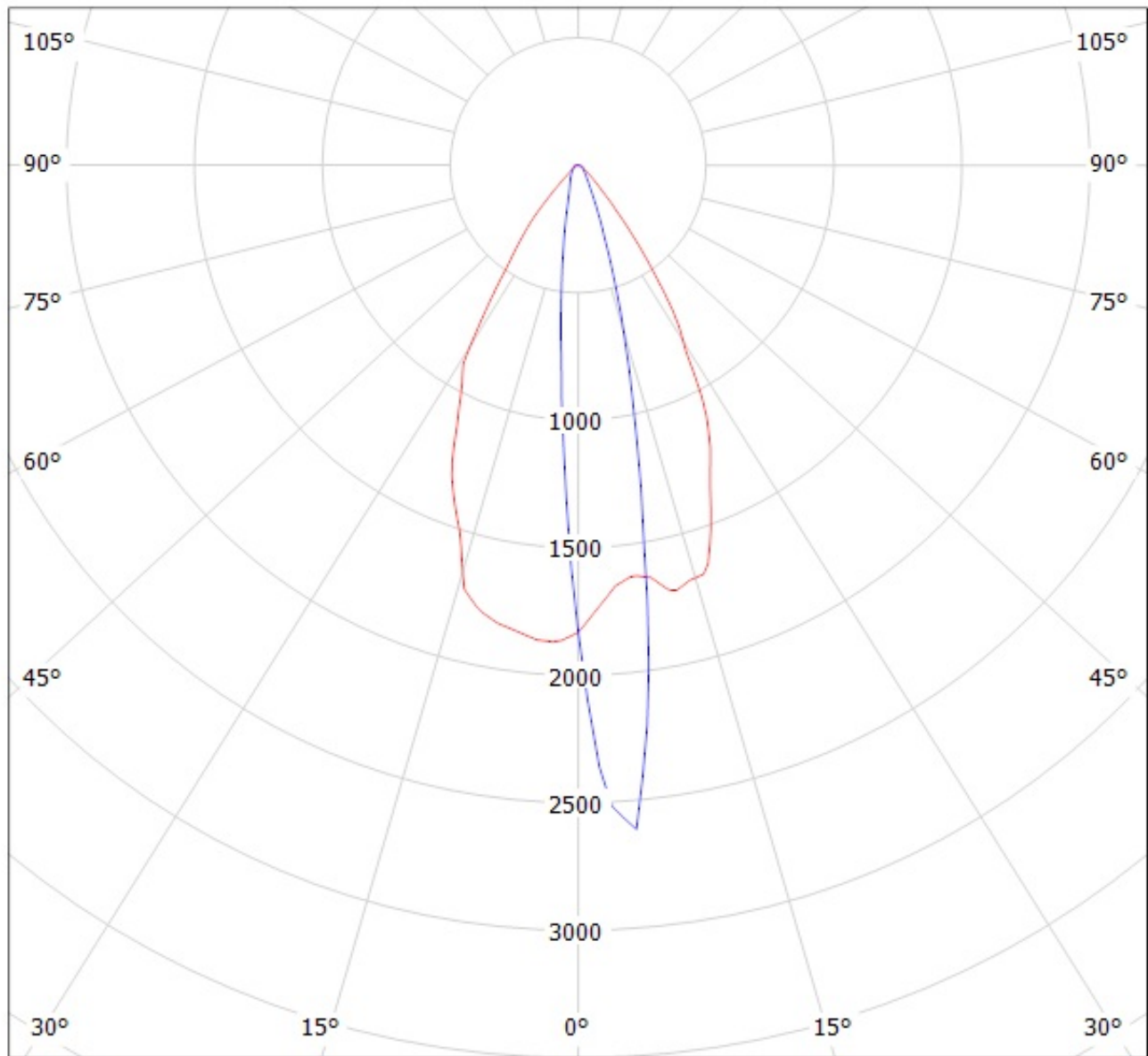

cd/klm  
— C0 - C180 — C90 - C270

Luminaire: Ledil Oy CP13308&CA13307\_LAURA-O-WAS-OSL150 (Osram oslon 150deg 95lm @ 250mA) Efficiency=84%  
Lamps: 1 x Osram oslon 150deg 95lm @ 250mA

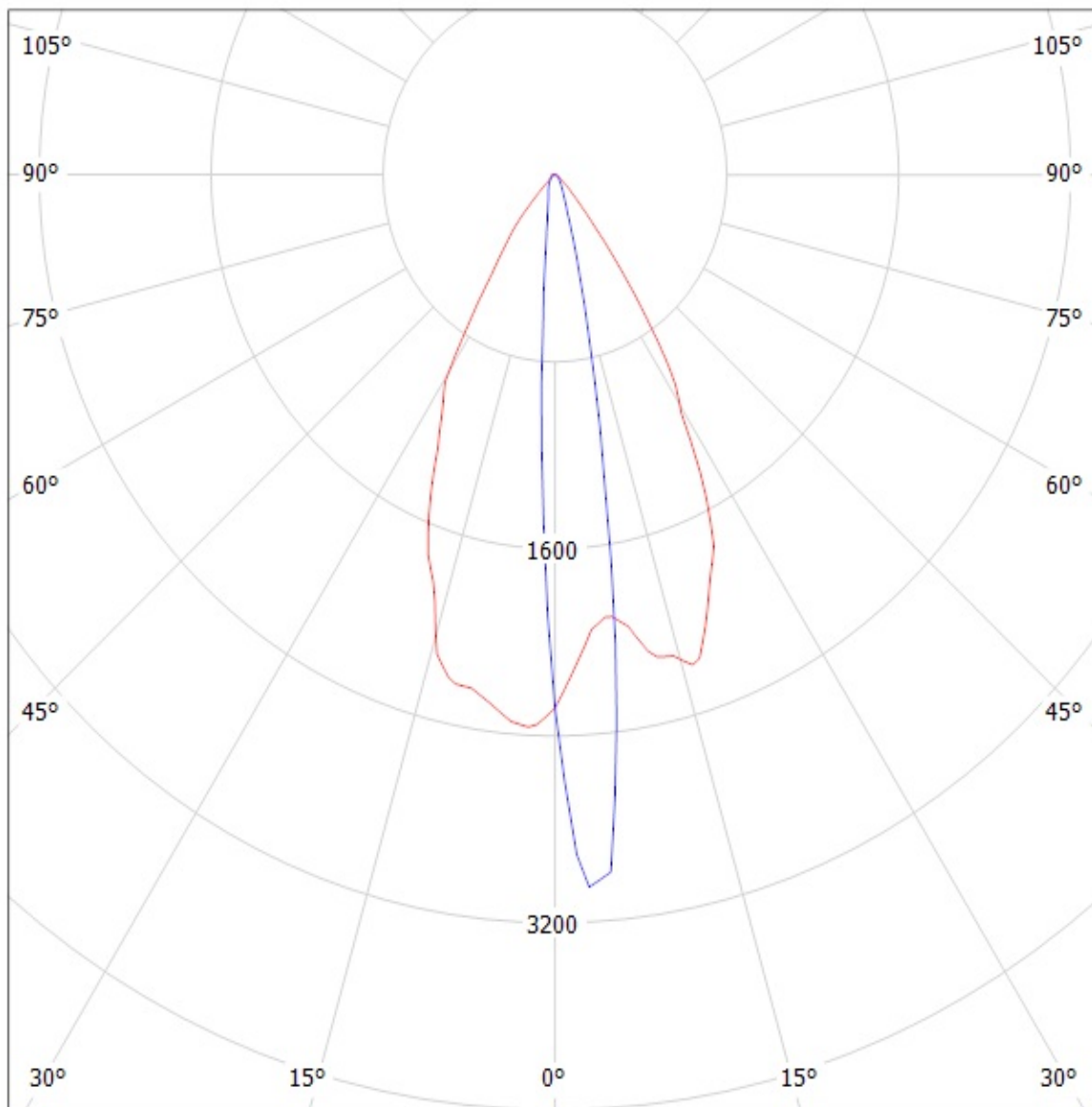

cd/klm

— C0 - C180 — C90 - C270

**NOTE: The typical divergence will be changed by different color, chip size and chip position tolerance. The typical total divergence is the full angle measured where the luminous intensity is half of the peak value.**