

JF2 EVK User Manual

1v0300987 Rev.1 – 2012-11-16



APPLICABILITY TABLE

PRODUCT
JF2



SPECIFICATIONS SUBJECT TO CHANGE WITHOUT NOTICE

Notice

While reasonable efforts have been made to assure the accuracy of this document, Telit assumes no liability resulting from any inaccuracies or omissions in this document, or from use of the information obtained herein. The information in this document has been carefully checked and is believed to be entirely reliable. However, no responsibility is assumed for inaccuracies or omissions. Telit reserves the right to make changes to any products described herein and reserves the right to revise this document and to make changes from time to time in content hereof with no obligation to notify any person of revisions or changes. Telit does not assume any liability arising out of the application or use of any product, software, or circuit described herein; neither does it convey license under its patent rights or the rights of others.

It is possible that this publication may contain references to, or information about Telit products (machines and programs), programming, or services that are not announced in your country. Such references or information must not be construed to mean that Telit intends to announce such Telit products, programming, or services in your country.

Copyrights

This instruction manual and the Telit products described in this instruction manual may be, include or describe copyrighted Telit material, such as computer programs stored in semiconductor memories or other media. Laws in the Italy and other countries preserve for Telit and its licensors certain exclusive rights for copyrighted material, including the exclusive right to copy, reproduce in any form, distribute and make derivative works of the copyrighted material. Accordingly, any copyrighted material of Telit and its licensors contained herein or in the Telit products described in this instruction manual may not be copied, reproduced, distributed, merged or modified in any manner without the express written permission of Telit. Furthermore, the purchase of Telit products shall not be deemed to grant either directly or by implication, estoppel, or otherwise, any license under the copyrights, patents or patent applications of Telit, as arises by operation of law in the sale of a product.

Computer Software Copyrights

The Telit and 3rd Party supplied Software (SW) products described in this instruction manual may include copyrighted Telit and other 3rd Party supplied computer programs stored in semiconductor memories or other media. Laws in the Italy and other countries preserve for Telit and other 3rd Party supplied SW certain exclusive rights for copyrighted computer programs, including the exclusive right to copy or reproduce in any form the copyrighted computer program. Accordingly, any copyrighted Telit or other 3rd Party supplied SW computer programs contained in the Telit products described in this instruction manual may not be copied (reverse engineered) or reproduced in any manner without the express written permission of Telit or the 3rd Party SW supplier. Furthermore, the purchase of Telit products shall not be deemed to grant either directly or by implication, estoppel, or otherwise, any license under the copyrights, patents or patent applications of Telit or other 3rd Party supplied SW, except for the normal non-exclusive, royalty free license to use that arises by operation of law in the sale of a product.



Usage and Disclosure Restrictions

License Agreements

The software described in this document is the property of Telit and its licensors. It is furnished by express license agreement only and may be used only in accordance with the terms of such an agreement.

Copyrighted Materials

Software and documentation are copyrighted materials. Making unauthorized copies is prohibited by law. No part of the software or documentation may be reproduced, transmitted, transcribed, stored in a retrieval system, or translated into any language or computer language, in any form or by any means, without prior written permission of Telit

High Risk Materials

Components, units, or third-party products used in the product described herein are NOT fault-tolerant and are NOT designed, manufactured, or intended for use as on-line control equipment in the following hazardous environments requiring fail-safe controls: the operation of Nuclear Facilities, Aircraft Navigation or Aircraft Communication Systems, Air Traffic Control, Life Support, or Weapons Systems (High Risk Activities"). Telit and its supplier(s) specifically disclaim any expressed or implied warranty of fitness for such High Risk Activities.

Trademarks

TELIT and the Stylized T Logo are registered in Trademark Office. All other product or service names are the property of their respective owners.

Copyright © Telit Communications S.p.A. 2012.



Contents

1. Introduction	7
1.1. Scope.....	7
1.2. Audience.....	7
1.3. Contact Information, Support	7
1.4. Text Conventions	8
1.5. Related Documents.....	8
2. Preparing for theJupiter-F2	9
What is Necessary	9
2.1. Installing the USB Drivers	9
2.2. Installing SiRFLive	9
3. Jupiter-F2 Evaluation Kit	10
3.1. What’s in the Box.....	10
3.2. Jupiter Evaluation Board.....	11
3.2.1. Switch Configuration	12
4. Step-by-Step: First Time Running the Jupiter-F2 Evaluation Board	13
4.1. Step-by-Step: First Time Connection.....	13
5. Jupiter-F2 on SiRFLive	15
5.1. Main Interface.....	15
5.2. Connecting To the Jupiter-F2	15
5.3. SiRFLive Windows	17
5.4. Receiver Commands.....	21
6. Battery Function on JF2	28
7. 5Hz Function on JF2	29
7.1. NMEA Messages.....	29
7.1.1. Enable 5Hz Update NMEA	29
7.2. One Socket Protocol (OSP) Messages.....	30
7.2.1. Enable 5Hz Update OSP	30
7.2.2. MID 136 – Mode Control	31



8. APPENDIX32

8.1. Flashing the Jupiter-F2 32

8.2. Going into Boot Mode and Hibernate Mode..... 33

8.3. Internal LNA and Antenna 33

9. Document History35



1. Introduction

1.1. Scope

Scope of this document is to give an overview of the Evaluation kit of the GPS standalone module JF2.

1.2. Audience

This document is intended for customers who are evaluating one or more products in the applicability table.

1.3. Contact Information, Support

For general contact, technical support, to report documentation errors and to order manuals, contact Telit Technical Support Center (TTSC) at:

TS-EMEA@telit.com
TS-NORTHAMERICA@telit.com
TS-LATINAMERICA@telit.com
TS-APAC@telit.com

Alternatively, use:

<http://www.telit.com/en/products/technical-support-center/contact.php>

For detailed information about where you can buy the Telit modules or for recommendations on accessories and components visit:

<http://www.telit.com>

To register for product news and announcements or for product questions contact Telit Technical Support Center (TTSC).

Our aim is to make this guide as helpful as possible. Keep us informed of your comments and suggestions for improvements.

Telit appreciates feedback from the users of our information.



1.4. Text Conventions



Danger – This information MUST be followed or catastrophic equipment failure or bodily injury may occur.



Caution or Warning – Alerts the user to important points about integrating the module, if these points are not followed, the module and end user equipment may fail or malfunction.



Tip or Information – Provides advice and suggestions that may be useful when integrating the module.

All dates are in ISO 8601 format, i.e. YYYY-MM-DD.

1.5. Related Documents

- JF2 HW User Guide,
- JF2 Product Description,



NOTE:

- To prevent ESD and EOS damage, a properly grounded ESD wrist strap should be worn when working inside the EVK.
- Do not alter switch positions while USB power is applied.
- Do not short the RF signal to ground if the antenna voltage is installed. Damage to the EVK may result.

NOTE:

Always follow ESD safety precautions when utilizing the Jupiter-F2 evaluation kit. For additional information on the Jupiter-F2, ask your sales representative for additional manuals, datasheets, support, etc.



2. Preparing for theJupiter-F2

What is Necessary

To use the Jupiter-F2 Evaluation kit, you will need:

- FTDI USB Drivers
- SiRFLive2.0 and above or
- SiRFDemo
- A PC with a USB port that fulfills the minimum software requirements:
 - Windows XP
 - .NET Framework 2.0
 - This will be automatically installed by the SiRFLive package if necessary (internet connection is required).
- A programmed/flashed Jupiter-F2 evaluation device.
 - SiRFlash_402 and above if needed to flash the Jupiter-F2 device.
 - GSD4e v4.1.0-P1 firmware to be flashed on the Jupiter-F2 device if needed.

2.1. Installing the USB Drivers

Before connecting the Jupiter-F2 Evaluation Kit, install the necessary USB drivers.

- 1 Double-click the USB driver executable and follow the directions to install the USB drivers.

2.2. Installing SiRFLive

NOTE SiRFLive does not work on 64-bit OS machine at this time!

Minimum PC requirements:

- Pentium CPU 2 GHz
- 1 GB of RAM
- 100 MB hard drive

Recommended

- 2 GB of RAM
- 1280 x 1024 screen resolution



Ensure that all previous installation versions of SiRFLive have been uninstalled before installing any newer versions!

Install the current SiRFLive with the attached installer. Follow the installer directions until finished. Users should allow SiRFLive to install to the default location – C:\Program Files\SiRF\SiRFLive, but it can be changed if necessary.



3. Jupiter-F2 Evaluation Kit

3.1. What's in the Box

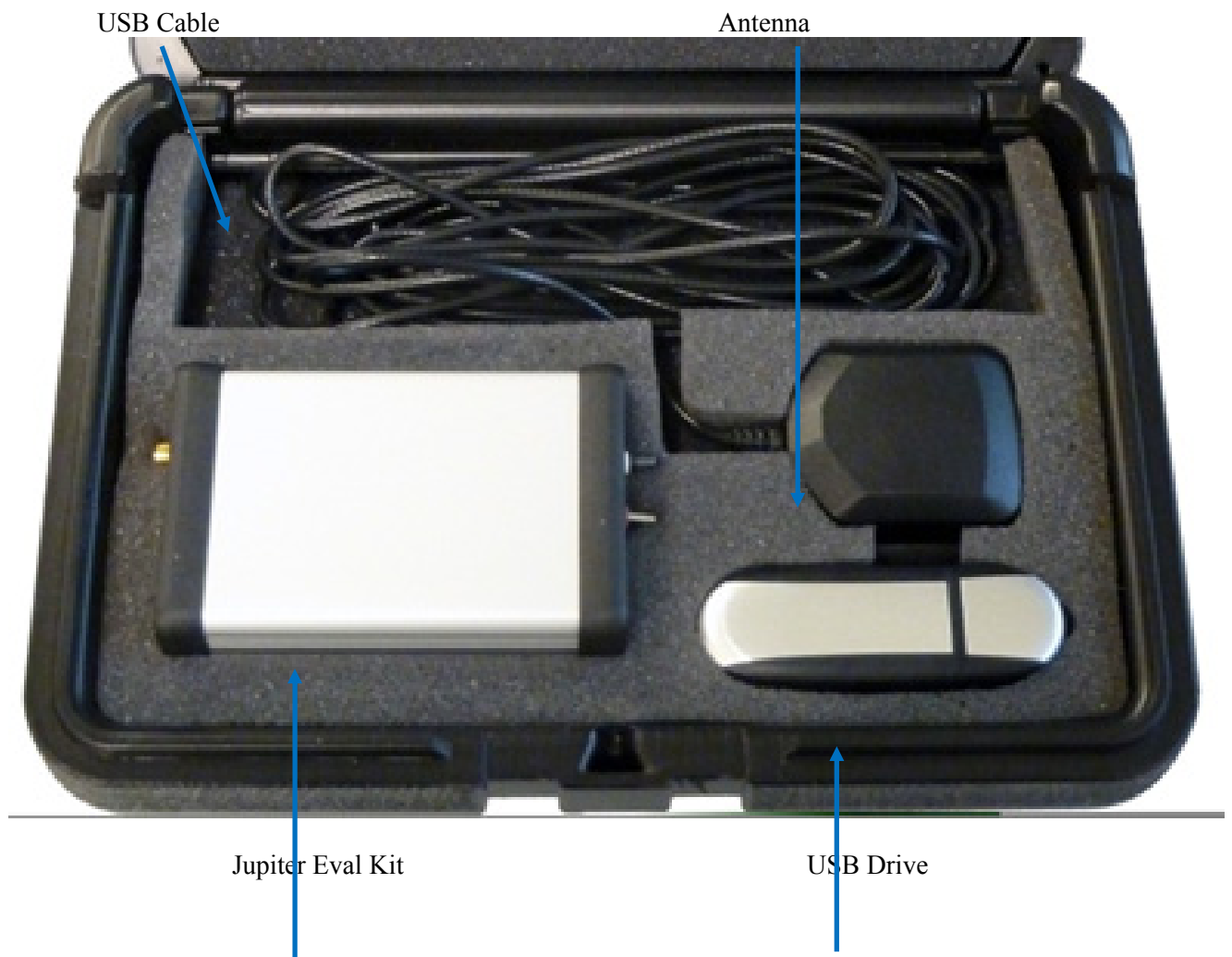

3.2. Jupiter Evaluation Board

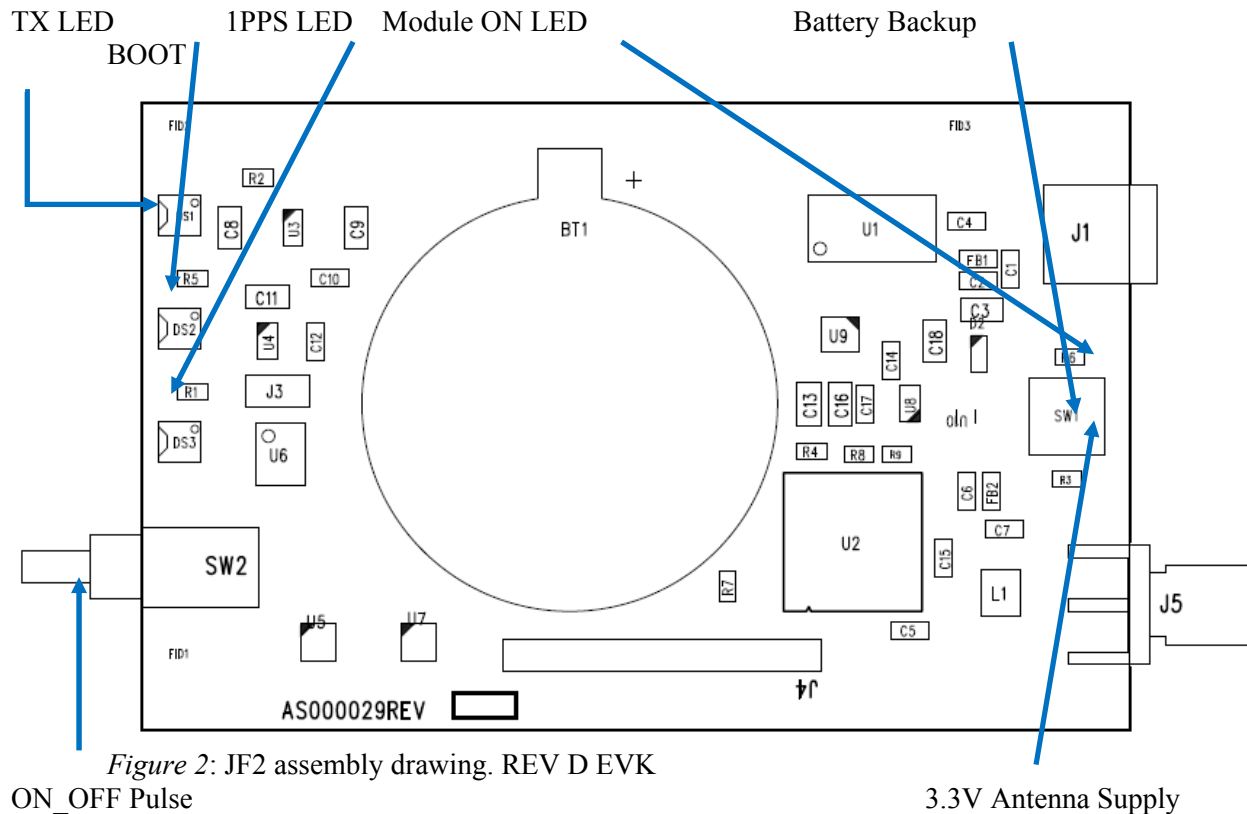
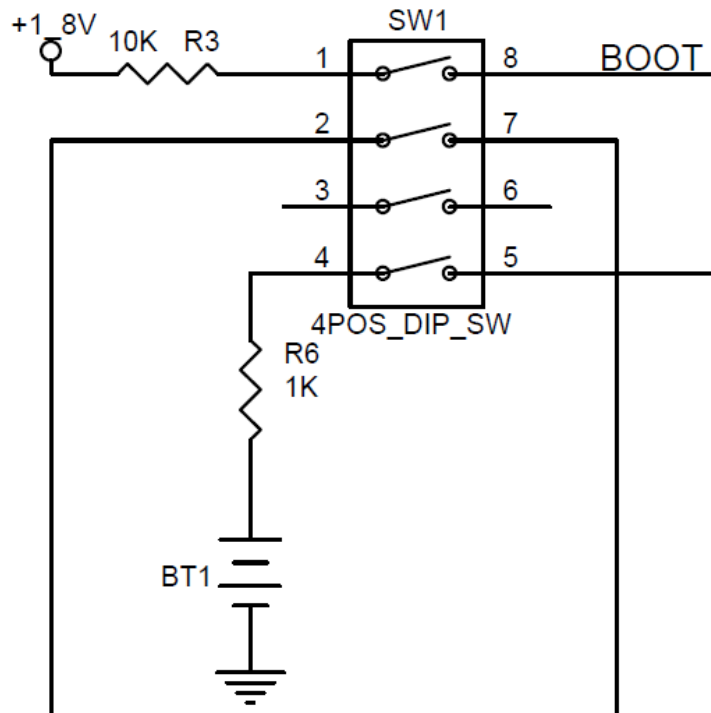

Figure 2: JF2 assembly drawing. REV D EVK

<u>Item</u>	<u>Function</u>
TX LED	LED that is tied to the USB to UART bridge TX line. The LED blinks whenever there is activity on the TX line.
1PPS LED	LED that pulses ON at ¼ a second and OFF at ¾ a second, indicating a fix with the receiver.
Module ON LED	LED indicating that the module is on. Led is tied to the SYSTEM_ON pin out of the Jupiter-F2.
ON_OFF Pulse	Pushbutton that sends a 1.8V voltage pulse to the ON_OFF input of the Jupiter-F2 module.
3.3V Antenna Supply	2 of SW1 pressed down provides a 3.3V output to an active antenna (depress if connecting a passive antenna).
BOOT Pin	1 of SW1 pressed down will pull the BOOT high, putting the module into internal BOOT mode for firmware flashing
Battery Backup Pin	4 of SW1 pressed down will utilize a 3V lithium battery installed on BT1. Refer to Section 5 on how to properly utilize a battery with the JF2.



3.2.1. Switch Configuration



	1	2	4
Normal GPS	(BOOT)	(Active Ant)	(Battery)
w/ provided Active Antenna no Battery	NO	YES	NO
w/ Passive Antenna no Battery	NO	NO	NO
w/ Active Antenna and Battery	NO	YES	YES
w/ Passive Antenna and Battery	NO	NO	YES
Flashing the GPS	YES	N/A	N/A

For Dip SW1



4. Step-by-Step: First Time Running the Jupiter-F2 Evaluation Board

The Jupiter-F2 evaluation board defaults to *hibernate mode* as soon as the USB is connected. It is important to understand the different power states in order to be in the correct mode for the desired operation.

4.1. Step-by-Step: First Time Connection

1. Before connecting the evaluation board, ensure that the USB drivers have been installed.
2. As soon as the evaluation board is connected to the PC, it will be detected and installed.

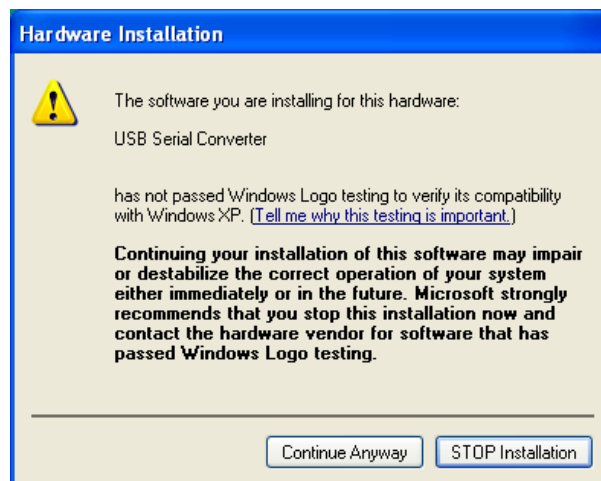

Figure 3: USB installation, select “Continue Anyway” to proceed.

3. After the evaluation board has been installed, check the “Device Manager” window for the evaluation board COM port number. This information is needed for use with the GPS tools.



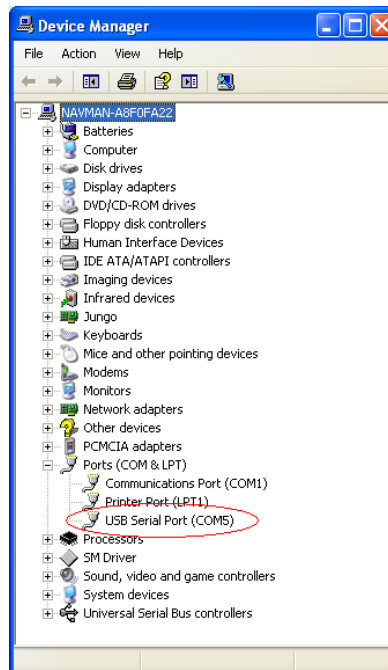

Figure 4: In this case, the COM port is assigned as COM5

1. At first application of power (connecting of USB), the evaluation board should default to *hibernate mode*. The **Module ON LED** should be unlit.
2. Depress position 1 of SW1 (**BOOT Pin**).
3. Press the **ON/OFF** pulse button to bring the unit into *Full Power Mode*.
4. The *Full Power Mode* will be indicated by the **Module ON LED**.
5. Connect the provided GPS Active Antenna. NOTE: The evaluation kit is outputting 3.3V to the antenna. For a passive antenna, position 2 of SW1 needs to be depressed.
6. Place the GPS Active Antenna to where it has a clear view of open sky.
7. The evaluation board can now be manipulated with the provided GPS tools (SiRFLive or SiRFDemo).
8. Refer to [Chapter 4: Jupiter-F2 on SiRFLive](#) for using the JF2 on SiRFLive.



5. Jupiter-F2 on SiRFLive

Launch the SiRFLive application.



5.1. Main Interface

After launching SiRFLive, first notice the application’s main interface.

File Receiver Features AGPS Window Help

Figure 5: Main Menu Bar



Figure 6: Main Tool Bar

5.2. Connecting To the Jupiter-F2

The user can utilize either the *Main Menu Bar* or the *Main Tool Bar*.

5.2.1.1. Main Menu Bar

Under the option “Receiver” on the *Main Menu Bar*, there is a selection “Connect. . .” This will open the Receiver settings for connection.

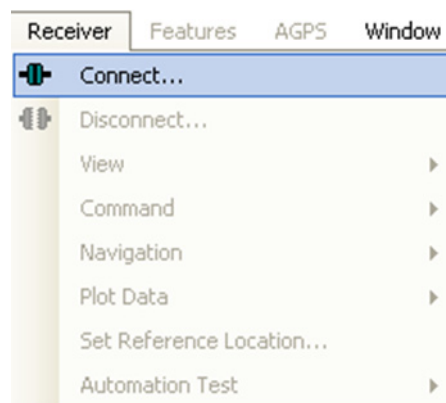

Figure 7: Connect to Receiver



5.2.1.2. Main Tool Bar



Select the “Receiver Settings” button



Or the “Connect” button



5.2.1.3. Rx Port Settings

Select the GSD4e Product Family, RS232/USB, and the Correct COM Port.

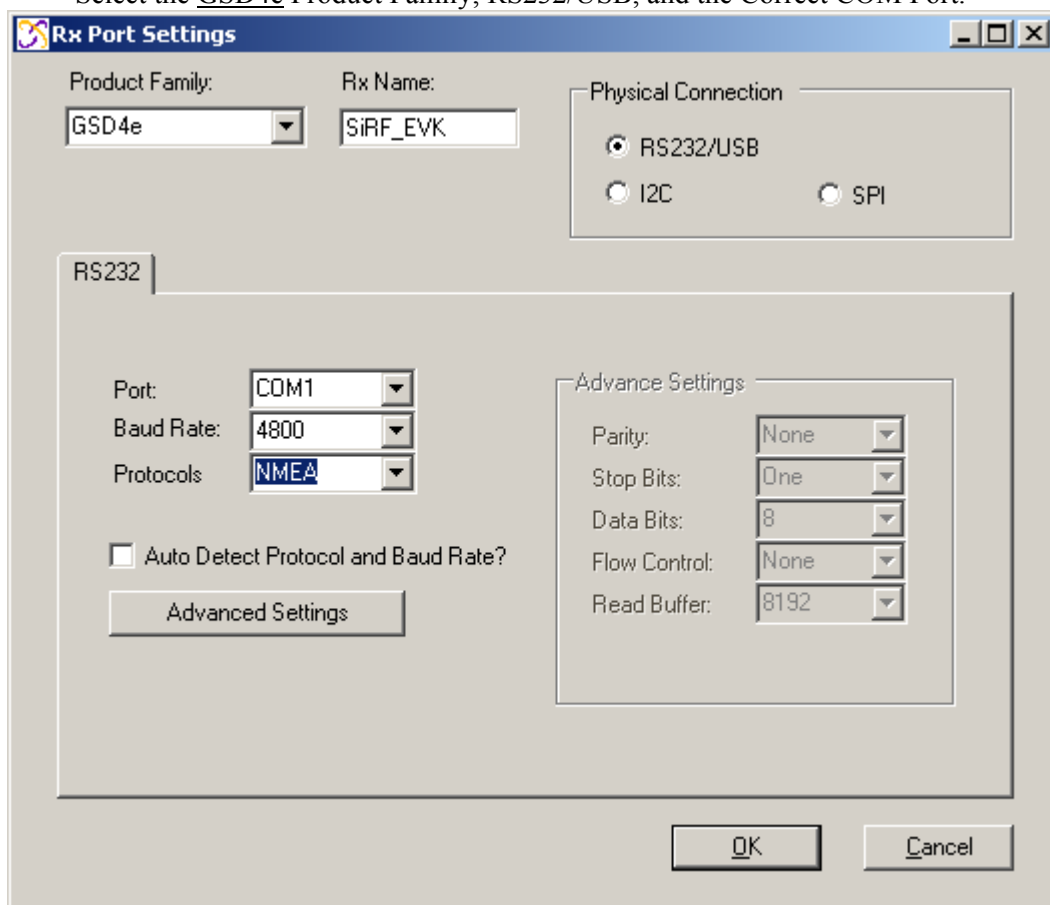

Figure 8: The Rx Port Connection Window



Default Baud rate for NMEA is 4800, and 115200 for OSP.

5.3.1.3. Debug View



(main tool bar icon)

Shows the communication messages with the receiver.

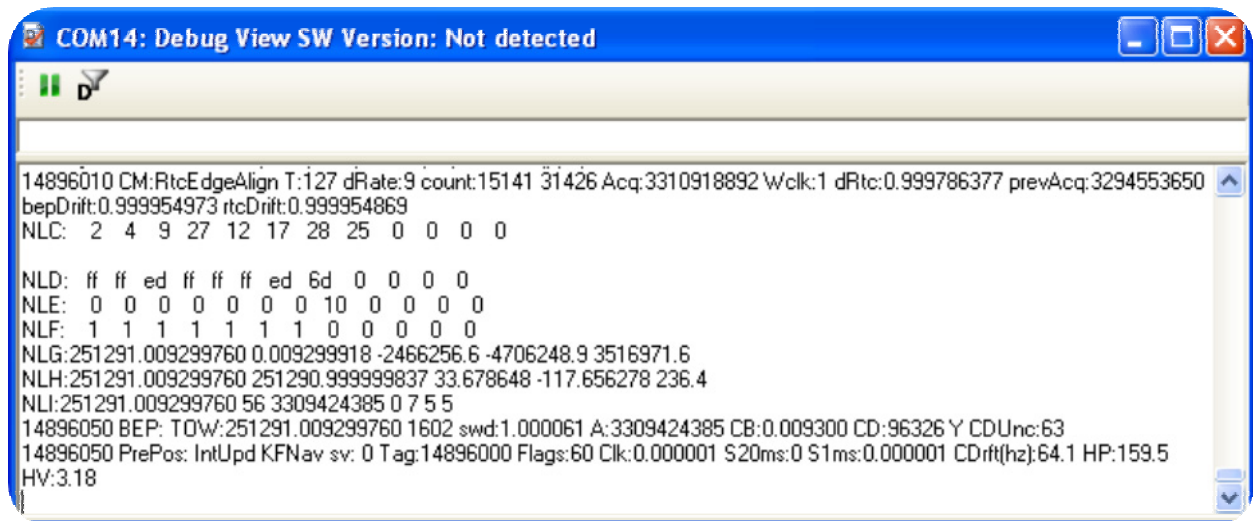

Figure 11: Debug view with One Socket Protocol messages.



5.3.1.4. Location View



(main tool bar icon)

Displays more detailed information regarding the UTC, TOW, Latitude, Longitude, Altitude, etc.

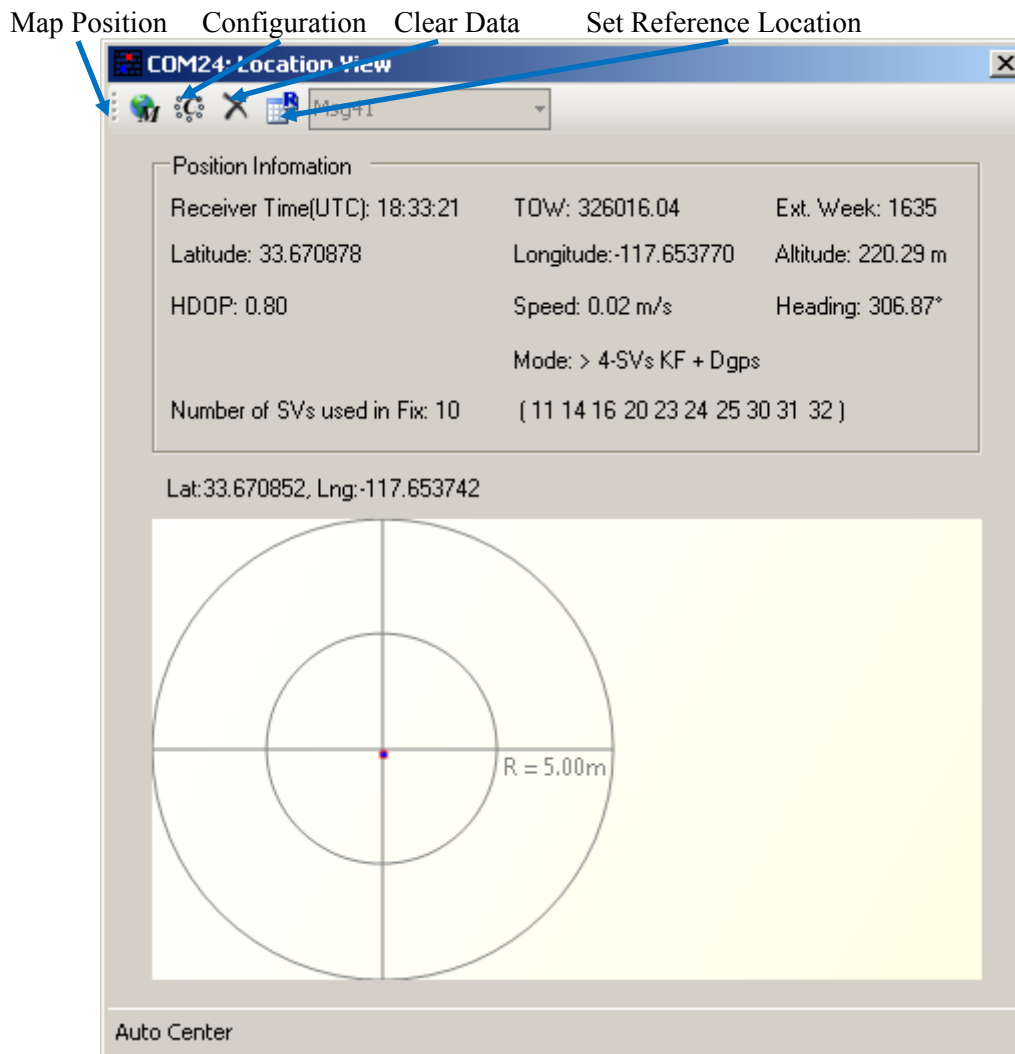

Figure 12: Location view



Map position button requires Internet access to work.

5.4. Receiver Commands

Most of the Receiver Commands can be accessed through the *Main Menu Bar* under “Receiver” > “Command.” There are also shortcuts on the *Main Tool Bar* which will be covered in this section.

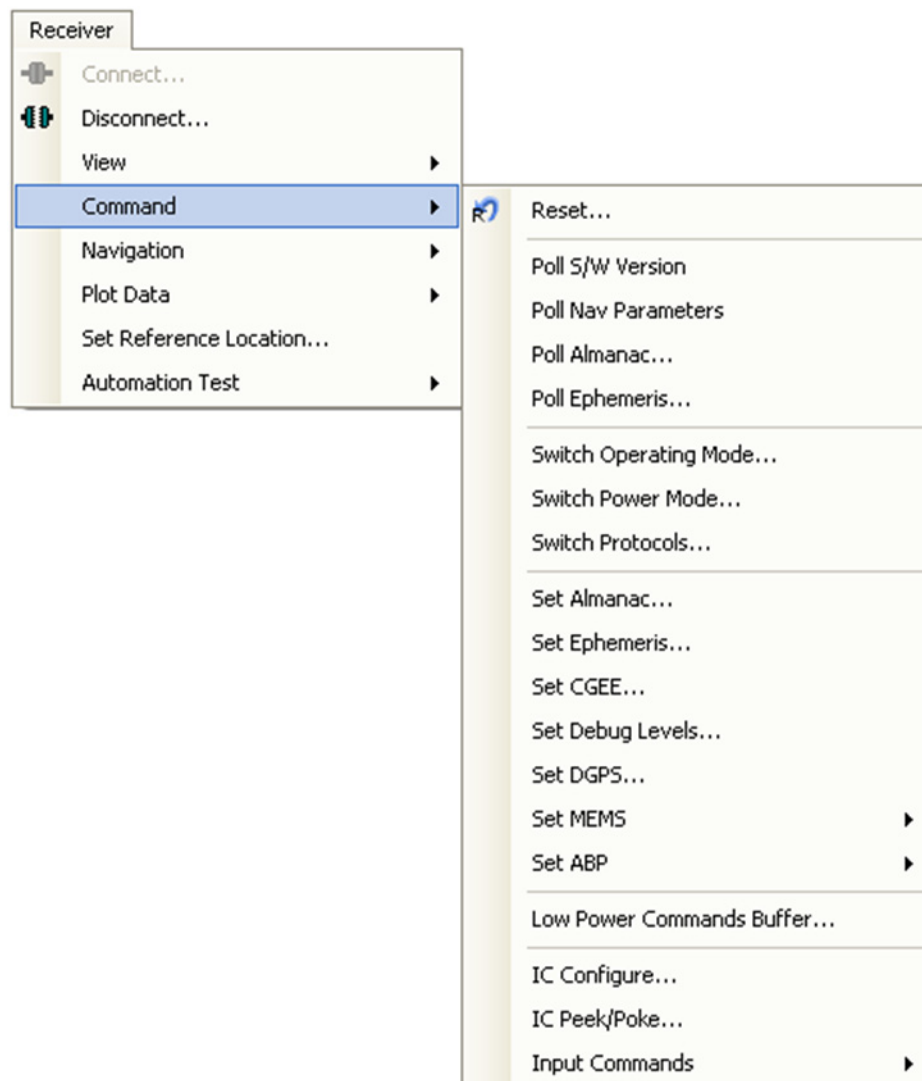

Figure 13: All the commands for the receiver.



All of the *Receiver Commands* become available in One Socket Protocol (OSP) only.

5.4.1.1. Sending Resets



(main tool bar icon)

1. Select “Reset. . .” under the *Main Menu Bar* “Receiver” > “Command” > “Reset. . .”

Or

Select the Reset icon on the *Main Tool Bar*.

The “Reset” window should open.

Reference Location allows the user to change the position used as the reference. This helps determine position accuracy in conjunction with Time-To-First-Fix values.

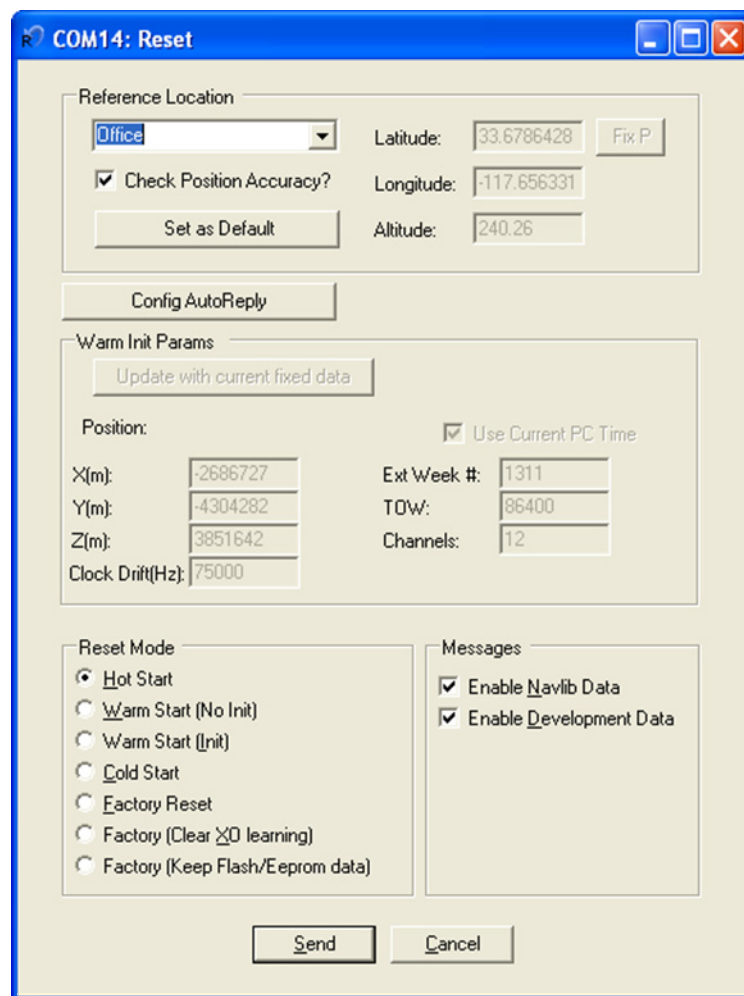

Figure 14: Reset window.



Resets are used to measure the TTF of the receiver. The TTF/Nav Accuracy window conveniently displays the TTF in seconds and Navigation accuracy based on the Reference Location.

5.4.1.2. Switch Protocol

The number of available commands in NMEA is limited compared to OSP. Switching to OSP for testing is recommended.

1. On the *Main Menu Bar*, select “Receiver” > “Command” > “Switch Protocols. . .”

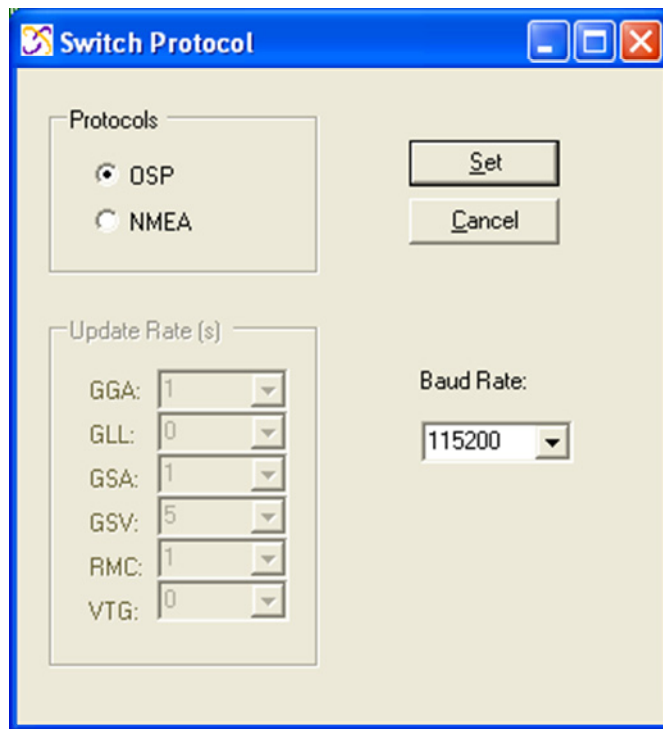

Figure 15: Switching to OSP protocol with its default 115200 baud rate

2. Click “Set” to apply settings.

Switching to NMEA should be similar.

5.4.1.3. Setting the IC Configuration

The Jupiter-F2 module has two LNA modes, a high gain mode, and a low gain mode. The high gain mode is ideal for passive antenna applications, while the low gain mode is ideal for active antenna applications.

LNA Gain Setting	Gain (dB)	Noise Figure (dB)	Recommended External Gain Range
Low	6.0–10.0	8.5–9.5	16–30
High	16.0–20.0	1.2–2.0	8–18

Table 1: LNA information and antenna gain requirements



The development kit hardware is set up to use an active antenna. The antenna feed is outputting 3.3V for the antenna. To ensure that no cross-correlation occurs, ensure that the correct LNA gain setting is selected for the chosen GPS antenna for use. In this case, the provided GPS antenna, the M820B-S, has 16dB typical gain.

1. On the *Main Menu Bar*, select “Receiver” > “Command” > “IC Configure. . .”
2. Click on “Advanced. . .” to open the IC Configuration fields.



A message will pop up warning about incorrectly configuring the IC parameters. Ensure that you are aware of the correct parameter changes so as not to render your receiver non-operational.

- i. Click “Yes” to proceed.
- ii. Under the selection “LNA Gain Mode:” choose “Low” from the drop down menu. Choosing Low will configure the internal LNA to its low gain mode. This will make the Evaluation Kit better fitted to work with an active antenna. *Figure 16* displays the IC Configuration window.



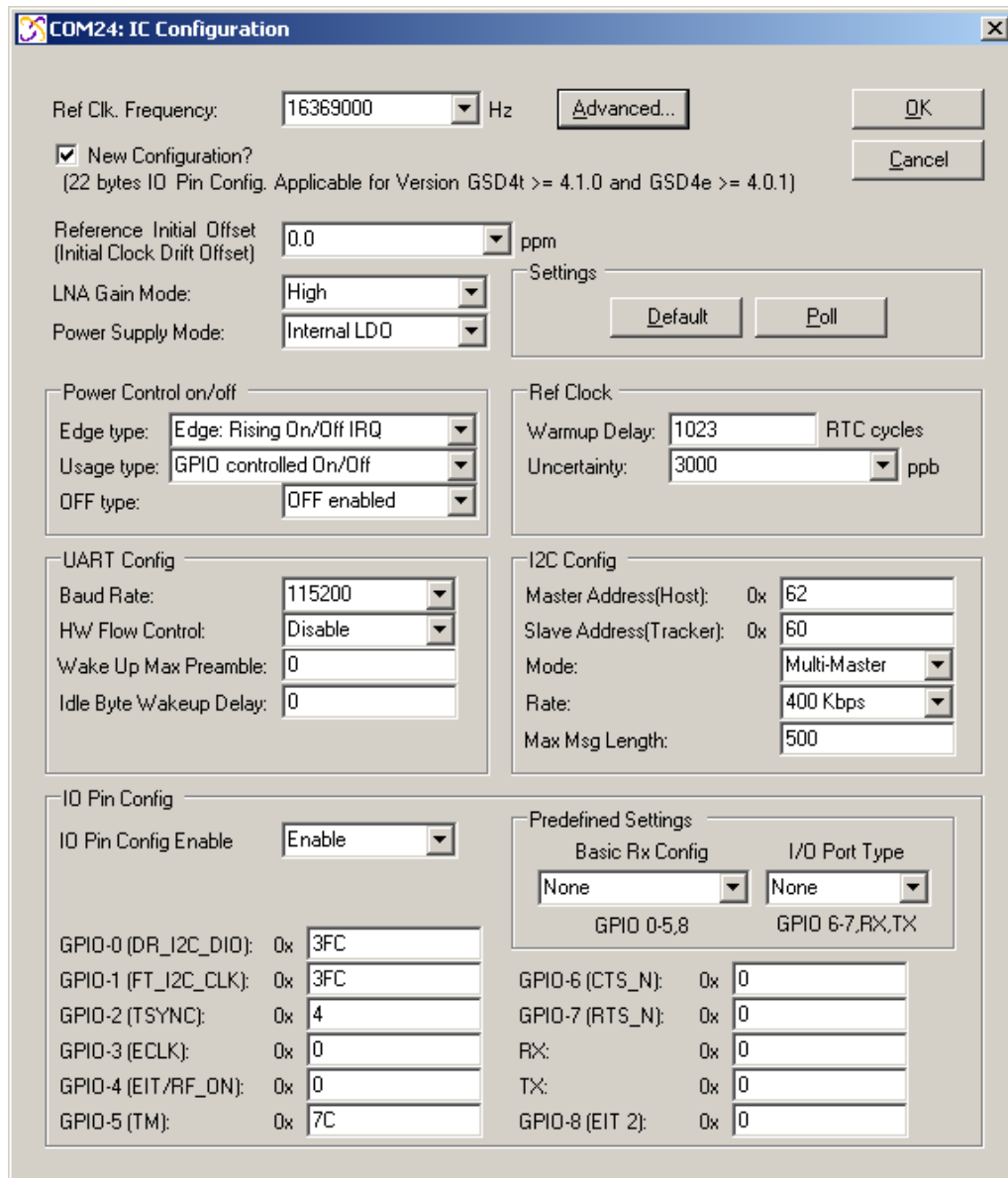

Figure 16: Configuring the IC parameters.

1. Click “OK” after all necessary changes.

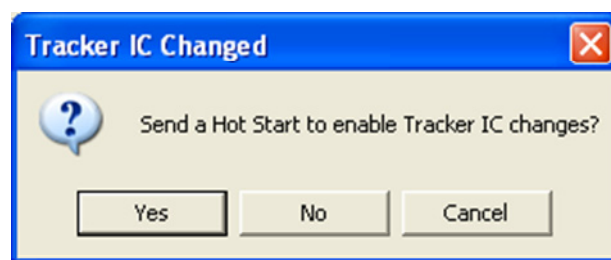

Figure 17: Click “Yes” in order for new changes to be applied.

5.4.1.4. Logging Data



(main tool bar icon)

SiRFLive is capable of collecting either the OSP message stream or the NMEA message stream into a log file.

1. While the receiver is outputting messages to SiRFLive, click on the *Log File* icon on the *Main Tool Bar* or go through the *Main Menu Bar* under “Log File” then “Start. . .” shown in Fig 18.

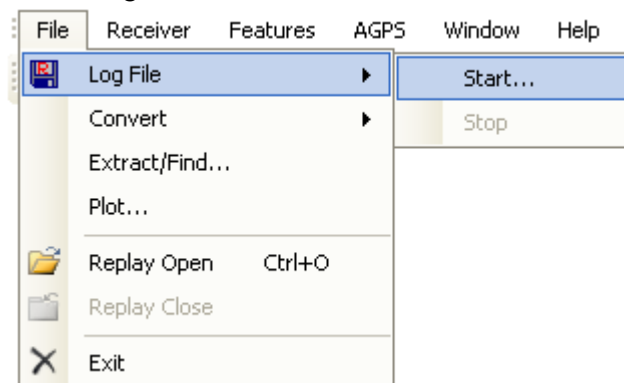

Fig 18: *Main Menu Bar* access to the Log File command.

- i. The *Log File* window should open, which is shown in Fig 19. Click on the “. . .” button, as indicated by the arrow in Fig 19, to open a window where the user can specify the output folder and the output file name.

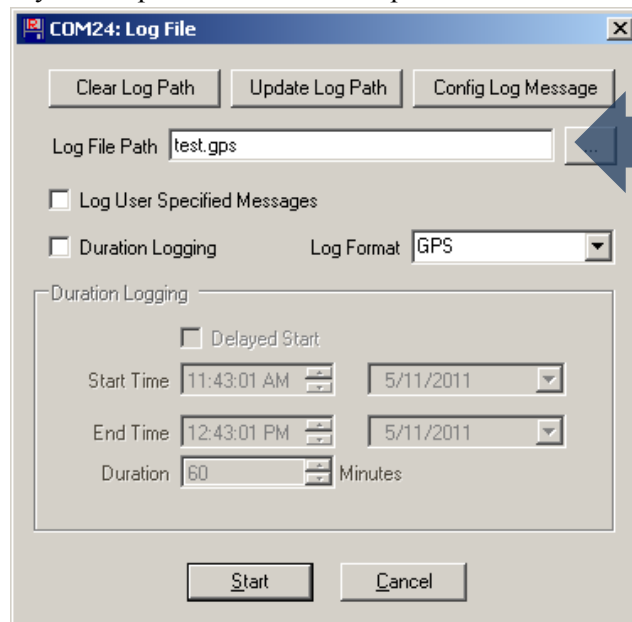

Fig 19: Clicking on the “. . .” button will give the user the control of the output folder and output name



- ii. After specifying the output folder and output name, close the “Specify log file name:” window by clicking *Open* and the “Log File Path:” bar should be filled with the file path. Select the desired Log Format, and click “Start” in order to start logging.



6. Battery Function on JF2

The JF2 evaluation kit supports the use of battery backup. If the 3V lithium coin cell is installed, and position 4 of SW1 is pressed (Battery Backup) then the evaluation kit will support battery backup. However, the procedure must adhere to the instructions below To safely enter battery backup:

1. While the evaluation kit is running, press the **ON_OFF Pulse** pushbutton. The **Module ON LED** should turn off.
2. Once the **Module ON LED** turns off, the USB cable can be removed. The JF2 will retain RTC time and battery backed memory.

If this procedure is not followed, the current limiting resistor on the backup battery will cause the supply voltage to sag enough that RTC time and battery backed RAM is lost.



Note that if the battery is not installed, the evaluation kit will still support hibernate mode with preserved battery backed RAM and RTC. The connected USB cable will be providing the *hibernate* voltage in this case.

To safely exit battery backup:

1. While the evaluation kit is in *hibernate* mode, connect the USB cable to the computer. Wait until the computer enumerates the USB port and applies power.
2. Press the **ON_OFF Pulse** button.



7. 5Hz Function on JF2

7.1. NMEA Messages

The JF2 default protocol is NMEA v3.0 at 4800 baud. The following messages are the default NMEA messages outputted by the JF2:

- RMC = 1 second update
- GGA = 1 second update
- GSA = 1 second update
- GSV = 5 second update

7.1.1. Enable 5Hz Update NMEA

Through SiRFLive, access the *Main Menu Bar*, under “Receiver” > “Navigation” > “Set 5Hz Nav” select “Enable 5Hz Nav.”



Note that for 5Hz update rate in NMEA mode, the receiver baud rate needs to be at least 38400 with all default NMEA messages On.

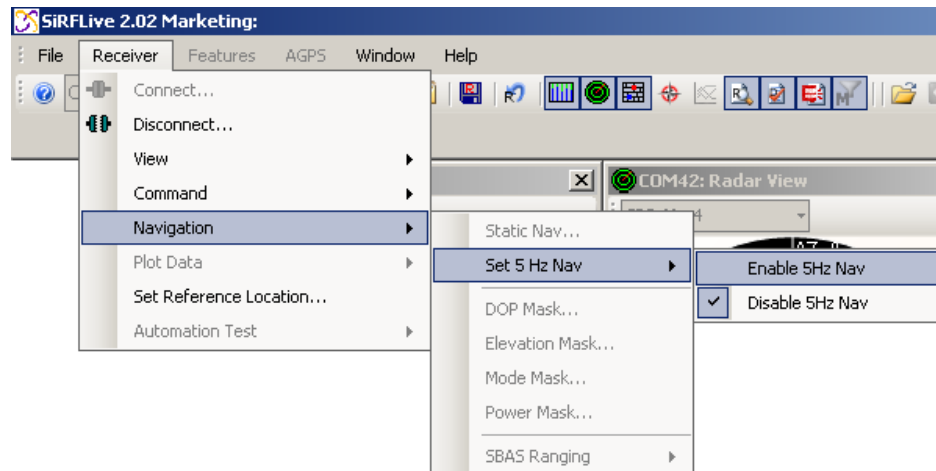

The “Enable 5Hz Nav” command in SiRFLive sends the following:

\$PSRF103,00,6,00,0*23

The “Disable 5Hz Nav” command in SiRFLive sends the following:

\$PSRF103,00,7,00,0*22

At the new 5Hz update rate, the default NMEA messages are output accordingly:

- RMC = 0.2 second update
- GGA = 0.2 second update
- GSA = 0.2 second update

GSV = 1 second update



7.2. One Socket Protocol (OSP) Messages

SiRF One Socket Protocol (OSP) is supported. This is an extension of the existing SiRF Binary protocol. The following messages are output once per second:

- MID 2
- MID 3
- MID 4
- MID 7
- MID 9
- MID 41
- MID 64 SUB ID 2 (One message for each satellite being tracked).
- MID 138

7.2.1. Enable 5Hz Update OSP

Through SiRFLive, access the *Main Menu Bar*, under “Receiver” > “Navigation” > “Set 5Hz Nav” select “Enable 5Hz Nav.”



Note that for 5Hz update rate in OSP mode, the receiver baud rate needs to be at least 57600 with all default OSP messages On.

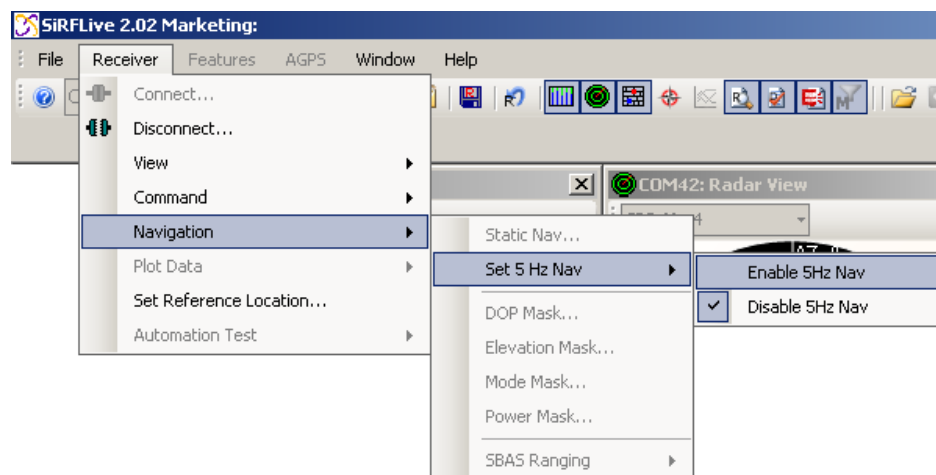

The “Enable 5Hz Nav” command in SiRFLive sends the following:

A0 A2 00 0E 88 00 00 04 04 00 00 00 00 00 00 0F 02 00 A1 B0 B3

The “Disable 5Hz Nav” command in SiRFLive sends the following:

A0 A2 00 0E 88 00 00 04 00 00 00 00 00 00 00 0F 02 00 9D B0 B3



7.2.2. MID 136 – Mode Control

Name	Bytes	Binary (Hex)		Unit	Description
		Scale	Example		
Message ID	1 U		88		Decimal 136
Reserved	2 U		0000		Reserved
Degraded Mode	1 U		01		Controls use of 2-SV and 1-SV solutions
Position Calc Mode	1 U		01		xxxx xxx0 = ABP, OFF xxxx xxx1 = ABP, ON xxxx xx0x = Reverse EE OFF xxxx xx1x = Reverse EE ON xxxx x0xx = 5Hz nav update OFF xxxx x1xx = 5Hz nav update ON xxxx 0xxx = SBAS Ranging use OFF xxxx 1xxx = SBAS Ranging use ON
Reserved	1 U		00		Reserved
Altitude	2 S		0000	meters	User specified altitude, range - 1,000 to 10,000
Alt Hold Mode	1 U		00		Controls use of 3-SV solution
Alt Hold Source	1 U		00		0 = Use last computed altitude 1 = User user-input altitude
Reserved	1 U		00		Reserved
Degraded Time Out	1 U		05	sec	0 = disable degraded mode, 1 to 120 seconds degraded mode time limit
DR Time Out	1 U		02	sec	0 = disable dead reckoning, 1 to 120 seconds dead reckoning mode time limit
Measurement and Track Smoothing	1 U		00000011		xxxxxxx0 = disable track smoothing xxxxxxx1 = enable track smoothing xxxxxxx0x = use raw measurements xxxxxxx1x = use smooth measurements



8. APPENDIX

8.1. Flashing the Jupiter-F2

It is usually not necessary for users to keep re-flashing the evaluation kit. New firmware will only be provided if necessary.



- 1 From *Hibernate Mode*, (**Module ON LED** unlit), press position 1 of SW1 and apply the **ON_OFF pulse** in order to go into Internal Boot mode. Fig. 2.
- 2 Double click the SiRFlash.exe icon to open the program.
- 3 Select Program, Internal Boot mode, Erase whole chip, and browse for the device firmware.
- 4 Select Execute.
- 5 Once in *Boot Mode*, the module will no longer respond to the **ON_OFF pulse**. Power needs to be removed in order to leave *Boot Mode*. This can be done by removing the USB cable and the **Battery Backup**.
- 6 Depress position 1 of SW1 and then re-apply power. Press the **ON_OFF pulse** and the unit will be in *Full-Power Mode* ready to communicate.



The evaluation Jupiter-F2 device needs to be in *BOOT mode* in order to flash. Press position 1 of SW1. Refer to Figure 2 for position location.

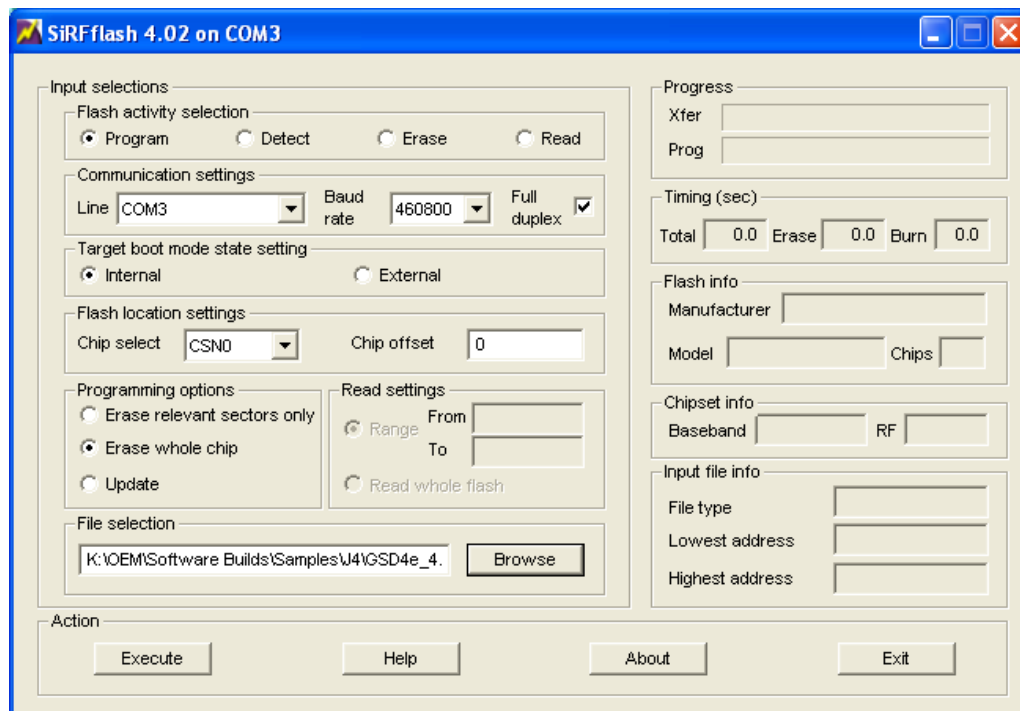

Figure 20: SiRFlash tool setting.



8.2. Going into Boot Mode and Hibernate Mode

The Jupiter-F2 Evaluation Board's main power comes from its USB port. Upon connection to a USB port, the evaluation kit defaults to its *hibernate mode*.



Hibernate mode is an ultra low power state that has both the RF and baseband turned off, leaving only the RTC and battery-backed RAM powered.

8.2.1.1. Going into Boot Mode

1. From hibernate mode (**Module ON LED** off), press position 1 (**BOOT**) of SW1.
2. Wake up the Jupiter-F2 module by pressing the **ON_OFF Pulse** pushbutton once.
3. Wait for the **Module ON LED** to turn on, indicating that the module has left *hibernate mode*.
4. It is now in Boot mode and ready to be flashed with firmware.

8.2.1.2. Going into Full Power Mode

1. From hibernate mode (Module ON LED off), ensure that position 1 (**BOOT**) is depressed.
2. Wake up the Jupiter-F2 module by pressing the **ON_OFF Pulse** pushbutton once.
3. Wait for the **Module ON LED** to turn on, indicating that the module has left *hibernate mode*.
4. It is now ready to communicate with software GPS tools.

8.3. Internal LNA and Antenna

The Internal LNA has two modes, each are specific to the amount of gain that a connected antenna will have.

Usually, in high gain internal LNA mode, the antenna connected will be a passive antenna, while the low gain internal LNA mode will require an active antenna or an external LNA. It is recommended for the AGC to be in mid-range (between 1 and 62). If the total system gain is too high, the AGC will be high, therefore it will not be able to compensate as well if the receiver is in a noisy environment.

The Jupiter-F2 evaluation is bundled with an Active Antenna, providing an amplifier gain of 16dB typical.



8.3.1.1. Active Antenna

The bundled M820B antenna requires a DC voltage between 2.7V to 6.0V. The Evaluation Kit can provide 3.3V to the active antenna by pressing position 2 of SW1. The active antenna should be low gain variety.



For passive antenna connection, ensure that position 2 of SW1 is depressed in order to prevent damage.

8.3.1.2. Passive Antenna

Open the box and ensure that position 2 of SW1 is depressed.



9. Document History

Revision	Date	Changes
0	2011-01-19	First issue
1	2012-11-16	Updated DIP switch for 3.3V antenna power (for Rev D EVK board)

