

Analog LV ChiP NBM™ Bus Converter Module Evaluation Board

Written by: Peter Makrum
 Applications Engineer
 June 2015

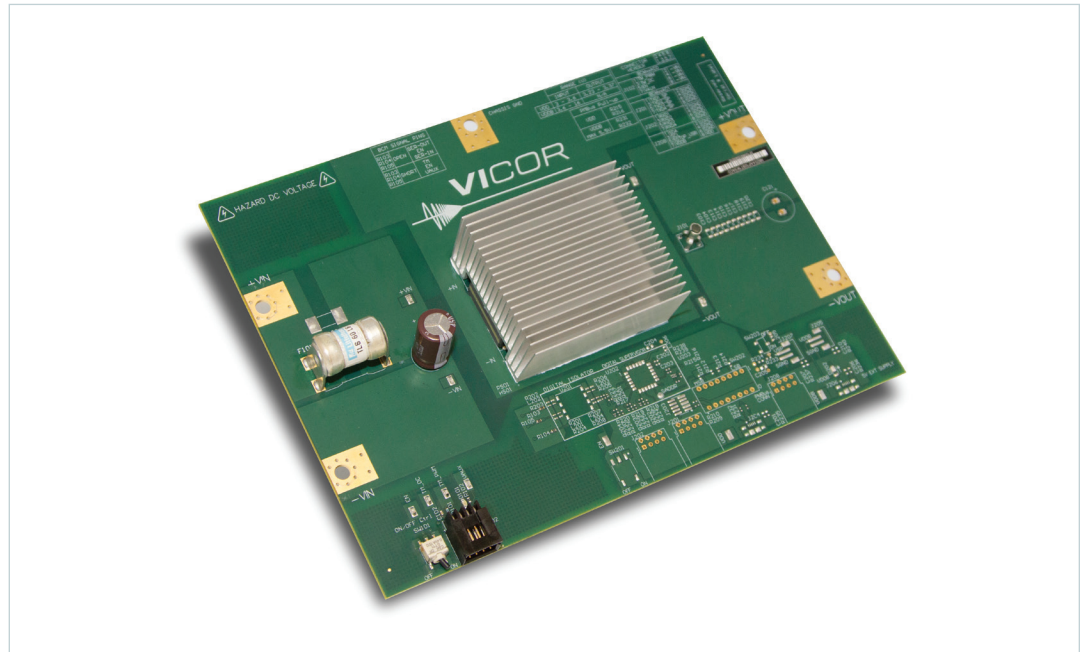

Contents	Page
<i>Introduction</i>	1
<i>Contents</i>	3
<i>Features</i>	3
<i>Board Description</i>	3
<i>General Components</i>	3
<i>Test Points Description</i>	6
<i>Schematics</i>	7
<i>Bill of Materials</i>	9
<i>Recommended Test Equipment</i>	10
<i>Basic Connections</i>	10
<i>Board Operation Details</i>	10
<i>Thermal Considerations</i>	11
<i>Paralleling</i>	11



Introduction

The Converter housed in a Package (ChiP) Bus Converter Module (BCM) evaluation board described in this document is designed to be used with the NBM family of non-isolated, DC-DC Bus converters. The Evaluation board is used for both the analog control, and digital control NBM products.

The focus of this document is to assist the user in evaluating the analog control version of the NBM family.

The NBM evaluation board can be configured for various enabling and fault monitoring schemes, as well as to exercise various loading conditions depending on the application requirements. The evaluation board can be used to evaluate NBMs in either a stand-alone configuration, or as an array of modules.

It is important to remember the fast response of NBMs can readily show the limitations of the source, load, and associated wiring connected to the evaluation board. Care should be exercised to minimize the stray source and load impedance in order to fully exercise the NBM.

The NBM non-isolated topology allows start up in forward and reverse directions and provides bidirectional protections. However if power train is disabled by any protection, and V_{SEC} is present, then voltage equal to V_{SEC} minus two diode drops will appear on primary side.



IMPORTANT NOTICE:

Read the precautions below entirely BEFORE using the NBM Evaluation Board. Do not operate the evaluation board unless you have the appropriate safety precautions in place on your bench to guarantee safety.

The list below is not comprehensive and is not a substitute for common sense and good practice.

- During operation, the power devices and surrounding structures can be operated safely at high temperatures.
- Remove power and use caution when connecting and disconnecting test probes and interface lines to avoid inadvertent short circuits and contact with hot surfaces.
- Never use a jumper in place of the fuse.
- When testing electronic products always use approved safety glasses. Follow good laboratory practice and procedures.
- Avoid creating ground loops between the SGND and PGND pins when making measurements.
- Care should be taken to protect the user from accidental contact when under power.
- Care should be taken to avoid reversing polarities if connecting to the opposite (solder) side of the board.
- The product evaluation boards described in this document are designed for general laboratory evaluation, and are not suitable for installation in end user equipment.
- Refer to the specific NBM module data sheet for electrical, thermal, and mechanical product details.

This board provides a convenient way to evaluate or demonstrate the performance of Vicor's NBM products. Kelvin connections are provided for accurate voltage measurements on power nodes. Sockets are provided to permit quick installation and changing of bulk filtering capacitors. The evaluation board also provides lugs for input / output connections, test points and sockets for easy connection to standard test equipment, and a high performance air-cooled heat sink assembly.

Enable Options:

1. Apply input voltage to the NBM primary or secondary pins greater than the under voltage lockout. (Default)
2. On-board mechanical switch
3. External control using available test point

Fault Monitor Options:

1. On-board LED: the VAUX pin drives a visible LED for visual feedback on the NBM status such as enabled or fault condition.

Contents

The evaluation board ships with the following contents:

- 1 x NBM evaluation board
- 1 x Top heat sink pre-installed
- 1 x hardware kit:
 - 1 x through-hole aluminum electrolytic output capacitor (C121)
 - 3 x Connector Receptacle 8 position
 - 2 x Connector socket 2 position
 - 5 x size 10 screws, lugs and washers

Features

The NBM evaluation board has the following features:

1. Input and output lugs for source and load connections
2. Appropriately rated input fuse
3. Input aluminum electrolytic capacitor for additional source decoupling
4. Basic output filtering footprint, including sockets to add through-hole output aluminum electrolytic capacitors
5. Toggle switch for enabling and disabling the NBM via the enable (EN) pin
6. Oscilloscope probe jack for accurate, high frequency output voltage measurements
7. Connectors for NBM signal pins (TM, EN, and VAUX) and temperature monitor filtered signal
8. Kelvin voltage test points for all power pins

Board Description

The following section provides a detailed description of the evaluation board components, test points and sockets.

General Components

1. (PS01) The NBM is inherently a reversible product. This means that a voltage source placed at the secondary will bias the power train and allow the units to power up. Note if the units is held in a disabled state using the EN pin any voltage applied to the secondary pins of NBM will appear on the primary pins minus two diode drops. Loading the primary in this state may permanently damage the unit since the load current path would be through the body diode of the primary stage FETs . See the NBM data sheet for additional insight.
2. Input lugs: Sized for #10 hardware. Use for making connection to the input source. This board does not contain reverse polarity protection. Check for proper polarity before applying the power. It is important to remember that noise from the source and voltage drops, will appear at the output of the bus converter multiplied by transformation ratio (K). The K factor is the ratio of the output voltage to the input voltage (V_{OUT} / V_{IN}).
3. Input fuse (F101 & F102): Appropriately rated for the NBM model installed on the board. The fuse is meant to protect against excessive damage in a short-circuit event.
4. Input filtering: aluminum electrolytic input capacitor (C101).

5. Enable / Disable switch (SW101): When actuator is towards “ON” text on the board, the (EN) pin will be open and the NBM will be enabled. When actuator is towards “OFF” text on the board, the (EN) pin will be connected to (SGND) pin and the NBM will be disabled. When switch (SW101) is “ON”, an external voltage source can control the EN pin state.
6. Signal connector (J102): provides access to the bus converter signal pins (TM, EN, and VAUX) as well as (TM_DC) externally filtered signal. All signal pins are reference to the primary non-isolated voltage return (SGND) pin.

Figure 1.
NBM signal connector (J102)

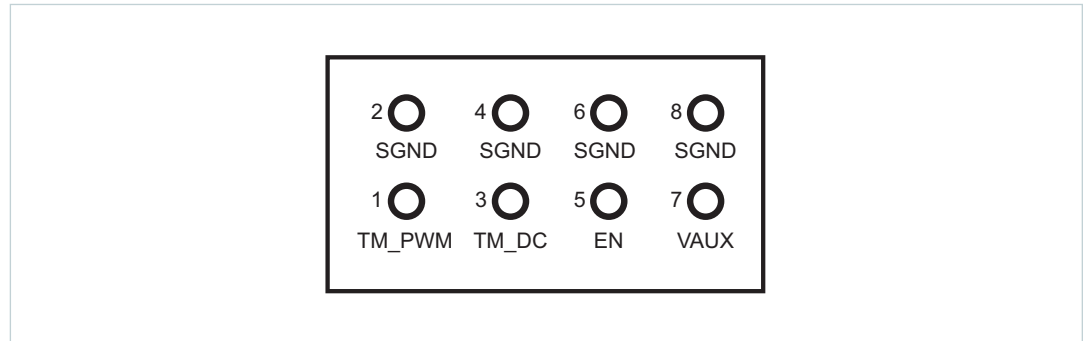

- Temperature Monitor (TM): The NBM (TM) pin outputs a 250 kHz PWM signal. A 1 kΩ and a 10 nF is the recommended low pass filtering solution. (TM_PWM) and filtered (TM_DC) are both accessible on (J102) connector header. (TM_DC) measures 1.27 V for a 27 °C internal temperature corresponding to a (TM_PWM) duty cycle of 38.48%
 - Enable Control (EN): Connecting the NBM (EN) pin to (SGND) will disable the module. (SW101) can be used to turn off the power train and disable the module. The (EN) pin is internally pulled up. During a fault condition, this signal and will remain high while input voltage is applied and greater than $V_{\mu C_ACTIVE}$. This connector can be used to bus the (EN) pin in an array allowing array synchronous startup.
 - Auxiliary Voltage Source (VAUX): The NBM (VAUX) can be used as a fault flag it is internally driven low during a fault condition. The (VAUX) pin can also be used as a ready to process full power flag. A 2 ms delay from power train active is introduced on this pin signaling the end of soft-start. During normal operation this pin can be used as an auxiliary supply up to 4 mA max load.
7. Output lugs: Sized for #10 hardware. Use these lugs to connect the output directly to the load.
 8. Output oscilloscope probe Jack (J101): Used for making accurate scope measurements of the output voltage (e.g. ripple). The jack is directly compatible with many common passive voltage probes models. Remove the grounding lead and insulating barrel of the probe and insert the probe tip and barrel directly into the jack, insuring that the probe tip sits in the center socket of the jack. To avoid the risk of an inadvertent short circuit, do not attempt to install while power is applied. This Johnson Jack is kelvin connected to the module output pins. The effect of the output capacitors will not be noticeable.

9. Output filter: 10x output ceramic capacitors 1206 footprint provision (C103, C104, and C113 - C120). In addition to socket (C121) that can be used for easy installation of an aluminum electrolytic output capacitor included with in hardware kit of the evaluation board.
10. Chassis ground: (R106) is a 2010 package. The footprint can be used to provide a convenient means to short the chassis and heat sink common ground to the power ground plane.

Figure 2.
PCB#42142 evaluation board
photo, top side

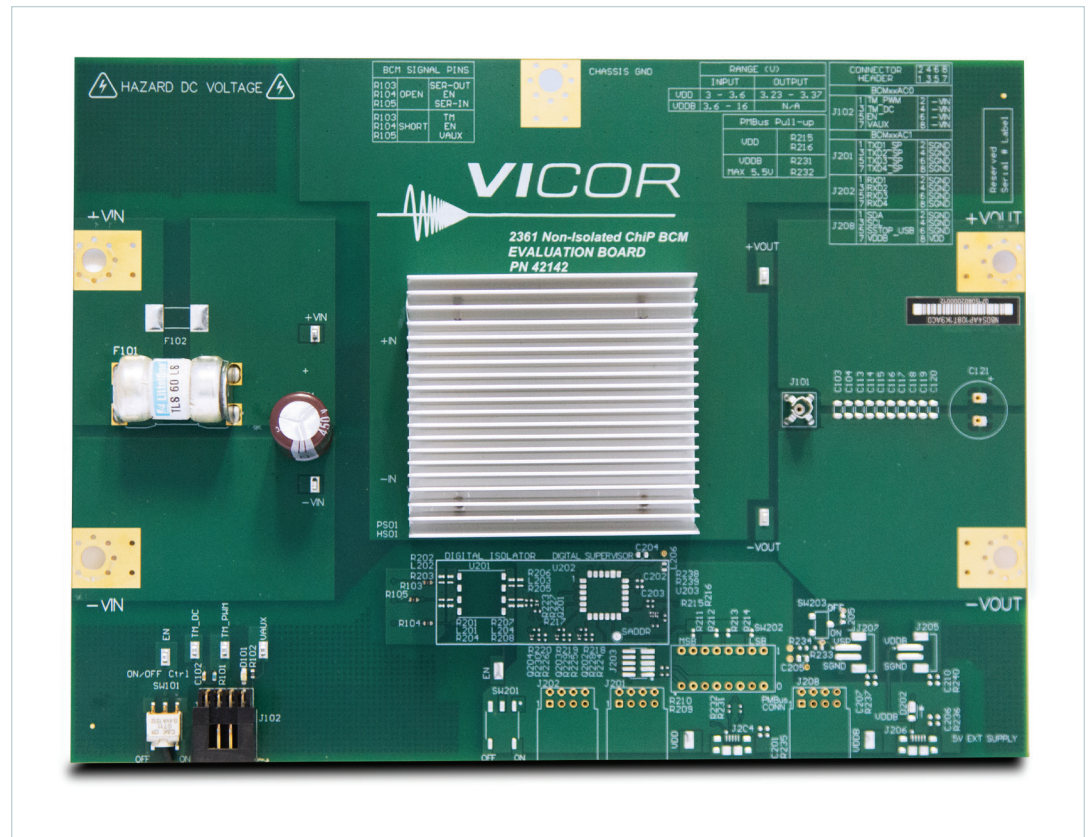

Test Points Description

Test nodes are labeled and include an SMT test point for attaching miniature probes, clips or hooks.

Table 1.
Test point descriptions

Name	Description
+V _{IN} , PGND	Provide measurement test points for the input voltage of the NBM module. Test points are Kelvin connected to the module input pins.
EN, SGND	Used to measure the NBM EN pin relative to SGND pin.
TM_DC, SGND	Used to measure the filtered NBM TM signal using a recommended low pass filter relative to SGND pin.
TM_PWM, SGND	Used to measure the NBM TM pin which is a pulse width modulated output signal relative to SGND pin.
VAUX, SGND	Used to measure the NBM VAUX pin output signal relative to SGND pin.
+V _{OUT} , PGND	Provide measurement test points for the output voltage of the NBM module. Test points are Kelvin connected to the module output pins.

Figure 3.
PCB#42142 evaluation board
schematic

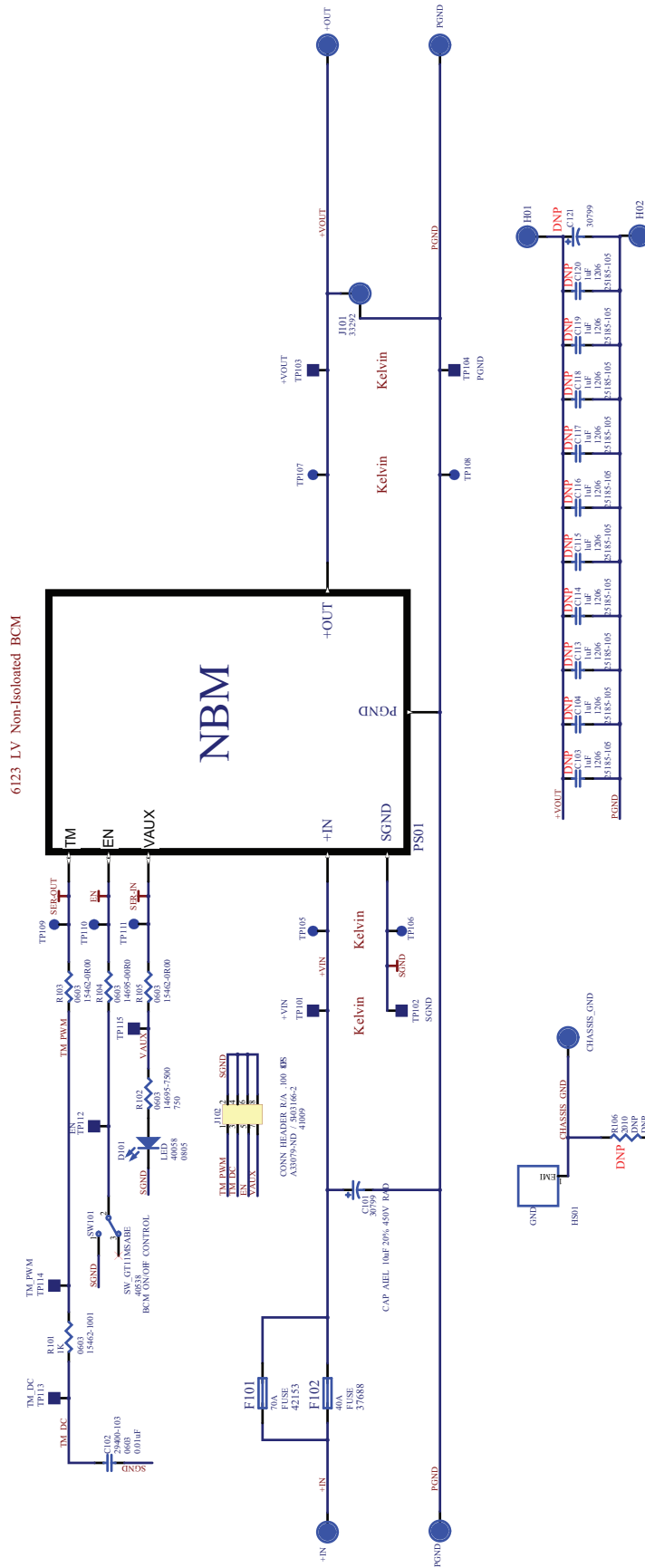

Figure 4.
PCB#42142 evaluation board,
top side

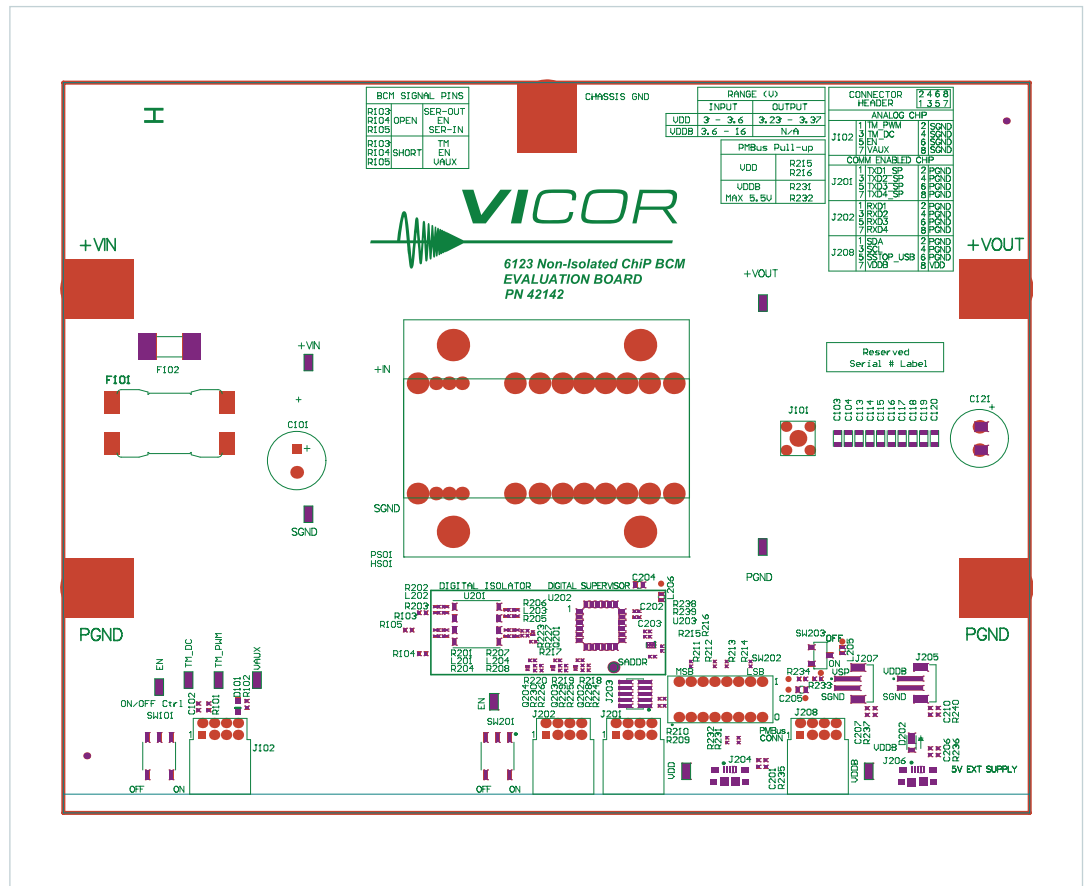
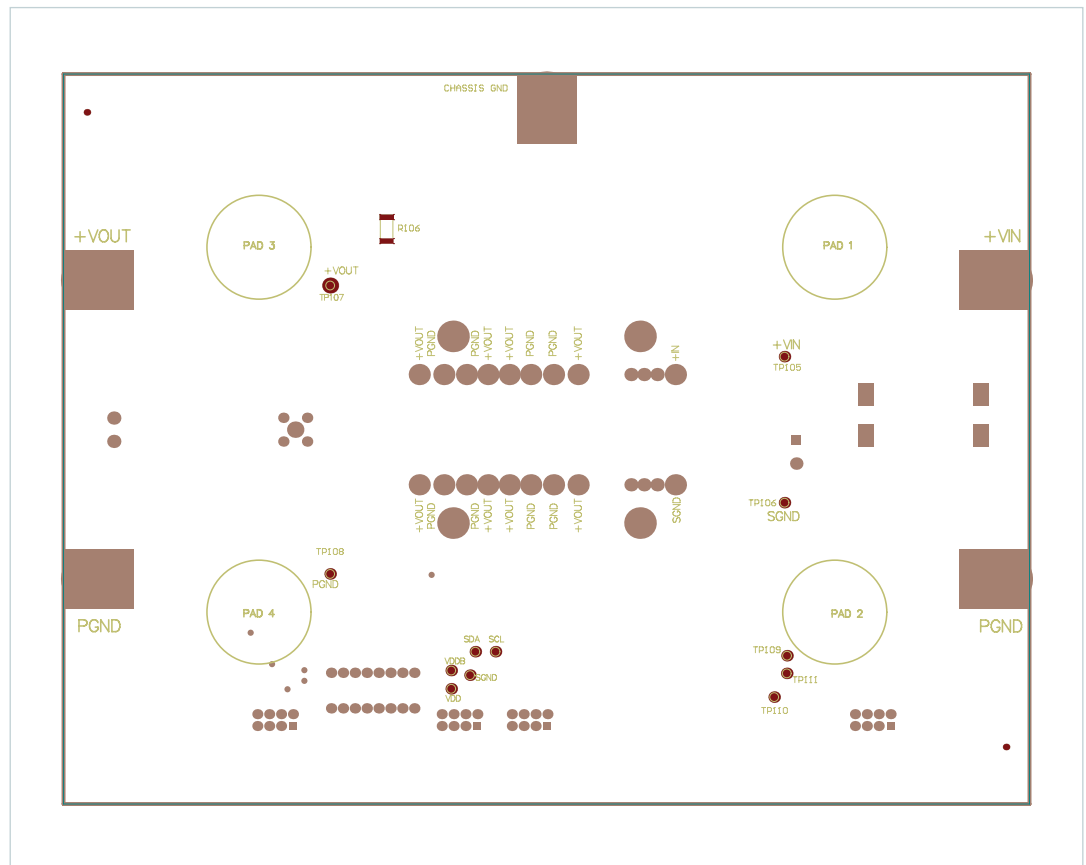

Figure 5.
PCB#42142 evaluation board,
bottom side



Bill of Materials

Following table describes the design specific components of the NBM evaluation boards.

Table 2.
NBM evaluation board components common to all boards

Reference Designator	Description	Manufacturer	Manufacturer Part Number
C101	CAP ALEL 10 μ 20% 450 V RAD	United Chemi-Con	EKXG451ELL100MK20S
C102	CAP X7R .010 μ F 10% 50 V 0603	Murata Manufacturing	GRM188R71H103KA01D
D101	DLED RED 0805	Rohm	SML-211UTT86
F101	Design specific - See Table 4		
F102			
J101	JACK VERTICAL MECH THRU HOLE	Tektronix	131-5031-00
J102	CONN HEADER R/A .100 8 POS 30 AU	TE Connectivity Ltd	5-103166-2
HTSNK	Design specific - See Table 4		
PCB Part Number	Design specific - See Table 4		
R103, R104, R105	RES 0 OHM JUMPER 1 A 0603	KOA Speer Electronics	RK73Z1JTDD
R102	RES 750 OHM 1/10 W 5% 0603	KOA Speer Electronics	RK73B1JTDD751J
R101	RES 1 K OHM 1/10 W 1% 0603	KOA Speer Electronics	RK73H1JTDD1001F
SW101	SW Horizontal SPDT 1 POS SMD	C&K Components	GT11MSABETR

Table 3.
BOM additions, components which are NBM model specific

Reference Designator	Description	Manufacturer	Manufacturer Part Number
Evaluation board numbers: NBM6123E60E12A7T0R; NBM6123E46C15A6T0R			
PS01	LV NBM	Vicor Corporation	NBM6123T60E12A7T0R; NBM6123T46C15A6T0R
PCB Part Number	NBM Evaluation Board	Vicor Corporation	42142
F101	FUSE 60 A 170 VDC THRU HOLE	Littelfuse	0TLS060.TXLS
HTSNK	BOM HEATSINK, TOP	Vicor Corporation	42676

Recommended Test Equipment

The following is a list of recommended test equipment.

1. Safety glasses
2. DC power supply: Refer to the specific NBM model datasheet to ensure the supply has sufficient power and current capability.
3. Electronic load: Refer to the specific NBM model datasheet to ensure the load has sufficient power handling and current capability for testing
4. Cooling fan
5. Digital multi-meters (DMMs)
6. Oscilloscope and probes
7. Interconnect wires, cables and fastening hardware

Basic Connections

- Confirm bench equipment is powered off.
- Connect the input DC power supply positive lead to the +IN input lug of the evaluation board, connect the input power supply negative lead to the PGND input lug of the evaluation board.
- Connect the CHASSIS_GND lug of the evaluation board to a safety “green wire” earth ground.
- Connect the +OUT lug of the evaluation board to the electronic load positive input, connect the PGND output lug of the evaluation board to the electronic load negative input.
- Verify proper polarity of the connections.
- Verify (SW101) desired actuator position
- Direct airflow from the cooling fan through the NBM heatsink fins.
- Have the latest NBM datasheet on hand for reference.

Board Operation Details

- SW01 provides control over enable.
 - In the “OFF” position, the switch will connect SGND pin to the EN net, which disables the NBM.
 - In the “ON” position, the EN net is allowed to float.
- External connection to EN is permitted using the EN test point. (SW01) should be set to “ON” to allow external control.
- The (J102) paralleling connectors can be used to connect EN nets across different boards. Note: to enable the NBMs in a parallel array, all boards need (SW01) set to “ON” to avoid pulling the EN node low.
- The heatsink assembly of the NBM is connected to the CHASSIS_GND lug. A connection from the CHASSIS_GND lug to earth ground is required for safety as the heatsink will be floating otherwise.
- The visible LED at D101 and its bias resistor network (R102 & R105) are connected to the VAUX pin. LED turns “ON” when VAUX is high signaling that the NBM is ready to process full power.

Thermal Considerations

The evaluation board is supplied with a pre-installed 27 mm top only for PCB#42142. A fan blowing across the evaluation board and heat sink assembly is required during operation at load. The fan should be placed about 4 inches away from the evaluation board facing the output voltage side. A typical bench top fan is recommended providing about 1000 LFM. Using the supplied rubber feet is also required in order to elevate the board about 0.4 inches off a flat surface and enable air flow underneath the PCB.

The PCB top layer used of the PCB#42142 is required to be of the same potential of the heatsink this is to allow heat transfer from the bottom of the ChiP and leads to the heatsink. Chromerics GEL-8010 is used on both top and bottom surface of the ChiP. (Between the ChiP top and heatsink as well as the ChiP bottom and the PCB). It is also required to apply to the heatsink extended surface resting on the PCB.

Paralleling

The paralleling and sharing performance of multiple NBMs can be easily demonstrated by stacking multiple evaluation boards and interconnecting the inputs and outputs with standoffs to create a parallel array. Each NBM in an array operates in the same way as it does as a stand-alone unit. With equal impedance, the load is effectively shared across multiple NBMs. Mismatches in this case are modest, and are further canceled by an effective negative voltage vs. temperature coefficient.

The following connections and settings should be used for an array of NBM evaluation boards:

- All NBMs in a parallel array must be the same model.
- The boards should be physically stacked using metal standoffs at the +IN & PGND input lugs, the +OUT & PGND lugs, and the CHASSIS_GND lug. This also connects these nodes electrically so that a single source, single load, and earth ground connection can be made to the system.
- The NBM is a three terminal device it is required to connect all PGND lugs to the same potential.
- Standoffs must be sufficient in length to avoid contact between boards, and to permit airflow to all NBMs in the system.
- If coordinated enable control then the paralleling connectors (J102) can be used to easily interconnect the EN pin across boards.
- The paralleling connector receptacle (J102) is provided to daisy chain EN signal and SGND. The receptacle will accept a wire size range 26 - 22 AWG, 0.12 - 0.3 mm² wires.

The paralleling and current sharing capability of the devices can be demonstrated by stacking multiple evaluation board and interconnecting the inputs, outputs, and power grounds with standoffs of sufficient current rating to create a parallel array. If synchronous startup is desired, connect EN pin 5 and SGND pin 6 in (J102) using a twisted pair to all respective pins in different paralleled units.

Figure 6.
NBM evaluation boards stacked
to form a high power parallel
array, using common PGND
and both Input
and output power terminals

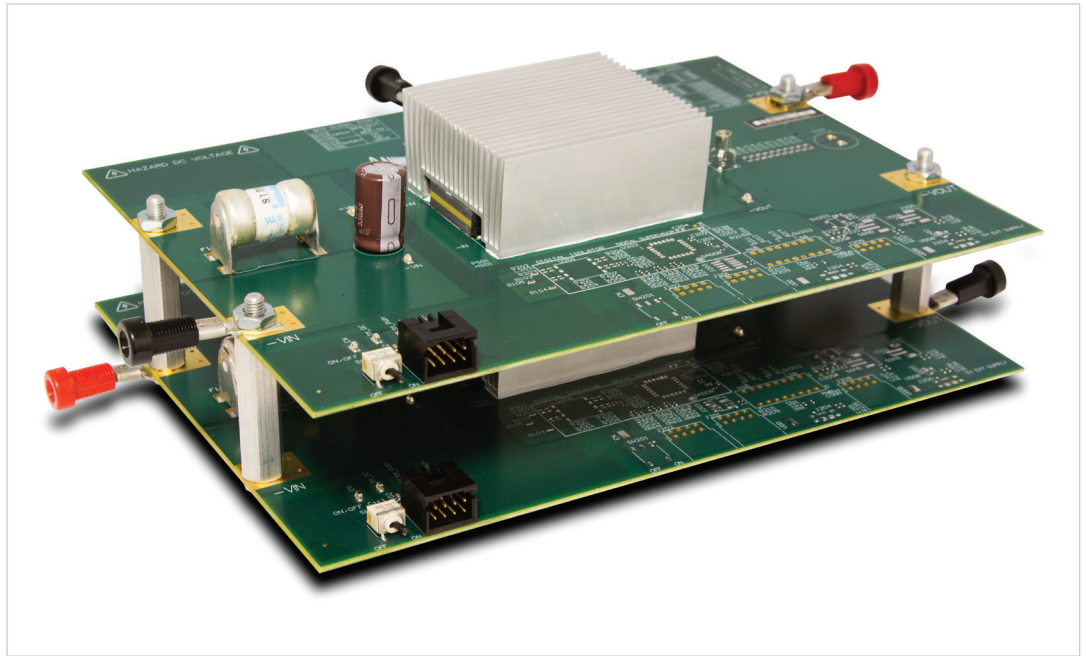

The Power Behind Performance