



ASE/F Series - Page B5



SE Series - Page B9



STS Series - Page B11



TSS Series - Page B16

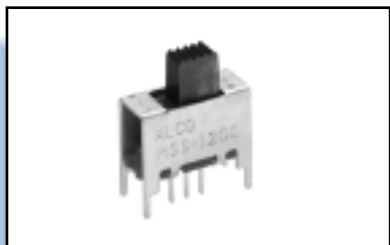

MSS Series - Page B18



MSSA Series - Page B24



MHS Series - Page B31



SSJ Series - Page B33

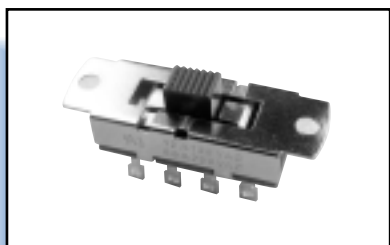

AC Power Slide Switches - Page B48

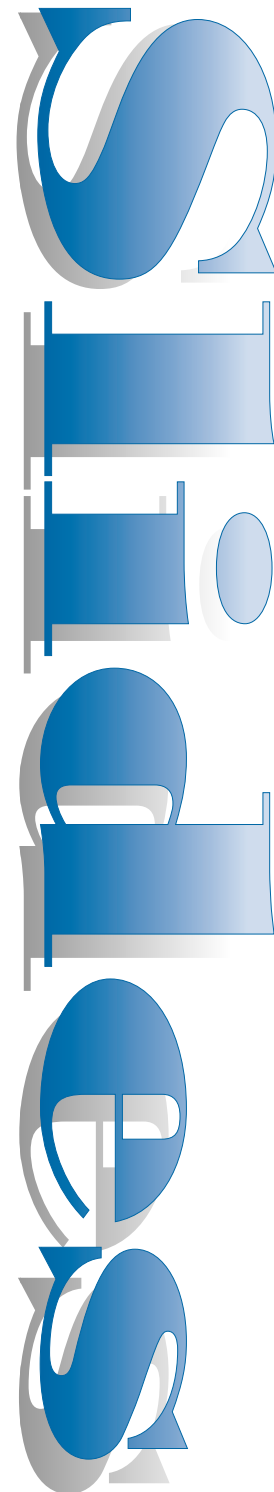

Slide Switches Part Number Index

B

Slide Switches

ASE22	B6	ASF62RS	B9	MSSA101DG	B31	SLS1211	B43
ASE22G	B6	ASF62S	B9	MSSA101DGRA	B32	SLS121PC	B43
ASE22GL	B6	CST022NK	B45	MSSA101EG	B31	SLS121RA	B43
ASE22GS	B7	CST023NK	B45	MSSA101EGRA	B32	SLS131PC	B44
ASE22L	B6	CST042NK	B46	MSSA104D	B31	SLS131RA	B44
ASE22R	B5,B6	CST043NK	B46	MSSA104D1	B31	SLS141PC	B44
ASE22RG	B6	CST062NK	B46	MSSA104DRA	B32	SLS141RA	B44
ASE22RGL	B7	KSS10A	B40	MSSA104E	B31	SLS151PC	B44
ASE22RGS	B7	KSS10B	B40	MSSA104ERA	B32	SLS151RA	B44
ASE22RL	B7	KSS20A	B40	MSSA111DG	B30	SLS220	B41
ASE22RS	B7	KSS20B	B40	MSSA111EG	B30	SLS2201	B42
ASE22S	B7	MHS122	B33	MSSA114D	B30	SLS220PC	B40
ASE42	B6	MHS122G	B33	MSSA114E	B30	SLS230PC	B40
ASE42G	B6	MHS122GRA	B34	MSSA1350	B26	SLS240PCA	B40
ASE42GL	B6	MHS122K	B33	MSSA1350G	B26	SLS250PC	B40
ASE42GS	B7	MHS122KG	B33	MSSA1350R	B26	SLS260PC	B40
ASE42L	B6	MHS122RA	B34	MSSA1350RG	B26	SLSA120	B41
ASE42R	B6	MHS123	B33	MSSA1450	B26	SLSA1201	B42
ASE42RG	B6	MHS123G	B33	MSSA1450G	B26	SLSA220	B41
ASE42RGL	B7	MHS123GRA	B34	MSSA1450R	B26	SLSA2201	B42
ASE42RGS	B7	MHS123K	B33	MSSA1450RG	B26	SSA12	B39
ASE42RL	B7	MHS123KG	B33	MSSA201NGRA	B32	SSA12G	B39
ASE42RS	B7	MHS123RA	B34	MSSA201PGRA	B32	SSA22	B39
ASE42S	B7	MHS133	B33	MSSA204N	B31	SSA22G	B39
ASE43	B6	MHS133G	B33	MSSA204N1	B31	SSB12	B38
ASE43G	B6	MHS133GRA	B34	MSSA204NRA	B32	SSB12G	B38
ASE43GL	B6	MHS133K	B33	MSSA204P1	B31	SSB12R	B38
ASE43GS	B7	MHS133KG	B33	MSSA204PRA	B32	SSB12RG	B38
ASE43L	B6	MHS133RA	B34	MSSA211NG	B30	SSB22	B38
ASE43R	B6	MHS222	B33	MSSA214N	B30	SSB22G	B38
ASE43RG	B6	MHS222G	B33	MSSA2350	B27	SSB22R	B38
ASE43RGL	B7	MHS222GRA	B34	MSSA2350G	B27	SSB22RG	B38
ASE43RGS	B7	MHS222K	B33	MSSA2350R	B27	SSB42	B38
ASE43RL	B7	MHS222KG	B33	MSSA2350RG	B27	SSB42G	B38
ASE43RS	B7	MHS222RA	B34	MSSA2450	B27	SSJ12	B35
ASE43S	B7	MHS223	B33	MSSA2450G	B27	SSJ12R	B35
ASE62	B6	MHS223G	B33	MSSA2450R	B27	SSJ13	B35
ASE62G	B5,B6	MHS223GRA	B34	MSSA2450RG	B27	STS121PC	B13
ASE62GL	B6	MHS223K	B33	MSSA3350	B28	STS121RA	B13
ASE62GS	B7	MHS223KG	B33	MSSA3350G	B28	STS1300PC	B14
ASE62L	B6	MHS223RA	B34	MSSA3350R	B28	STS1300RA	B14
ASE62R	B6	MHS233	B33	MSSA3350RG	B28	STS131PC	B13
ASE62RG	B6	MHS233G	B33	MSSA3450	B28	STS131RA	B13
ASE62RGL	B7	MHS233GRA	B34	MSSA3450G	B28	STS1400PC	B14
ASE62RGS	B7	MHS233K	B33	MSSA3450R	B28	STS1400RA	B14
ASE62RL	B7	MHS233KG	B33	MSSA3450RG	B28	STS141PC	B14
ASE62RS	B7	MHS233RA	B34	MSSA4350	B29	STS141RA	B14
ASE62S	B7	MLL1200S	B47	MSSA4350G	B29	STS151PC	B15
ASF22	B5,B8	MLL1200STR	B47	MSSA4350R	B29	STS151RA	B15
ASF22G	B8	MLL1300S	B47	MSSA4450	B29	STS161PC	B15
ASF22GL	B8	MMS12	B36	MSSA4450G	B29	STS161RA	B15
ASF22GS	B9	MMS22	B36	MSSA4450R	B29	STS220PC	B16
ASF22L	B8	MMS22R	B36	MSSA4450RG	B29	STS2300PC	B15
ASF22R	B5,B8	MMS23	B36	S1DGPC	B12	STS230PC	B16
ASF22RG	B8	MMS23R	B36	S1DGRA	B12	STS2400PC	B15
ASF22RGL	B9	MMS42	B37	S1EGPC	B12	STS240PC	B16
ASF22RGS	B9	MMS42R	B37	S1EGRA	B12	STS250PC	B16
ASF22RL	B9	MMS43	B37	S2DGPC	B12	STS260PC	B16
ASF22RS	B9	MMS43R	B37	S2DGRA	B12	STSA220RA	B16
ASF22S	B9	MSS1200	B20	S2EGPC	B12	STSA220RA1	B16
ASF42	B8	MSS1200G	B20	S2EGRA	B12	STSA230RA	B16
ASF42G	B8	MSS1200R	B20	SDS1240RA0	B17	STSA230RA1	B16
ASF42GL	B8	MSS1200RG	B20	SDS1240RA8	B17	TSD21AAGPC	B18
ASF42GS	B9	MSS1300	B20	SDS1340RA0	B17	TSD21DDGIPC	B18
ASF42L	B8	MSS1300G	B20	SDS1340RA8	B17	TSD21DDGIRA	B19
ASF42R	B8	MSS1300R	B20	SDS2240RA0	B17	TSD21DDGPC	B18
ASF42RG	B8	MSS1400	B21	SDS2240RA8	B17	TSD21DDGIRA	B19
ASF42RGL	B9	MSS1400G	B21	SDS2340RA0	B17	TSD21IEEGIRA	B19
ASF42RGS	B9	MSS2225	B21	SDS2340RA8	B17	TSD21IEEGRA	B19
ASF42RL	B9	MSS2225G	B21	SE1DGPC	B12	TSD21RGIPC	B18
ASF42RS	B9	MSS2250	B21	SE1DGRA	B12	TSS11AGIPC	B18
ASF42S	B9	MSS2250G	B21	SE1DGRA	B12	TSS11AGPC	B18
ASF43	B8	MSS2250R	B22	SE1DGSMT	B11	TSS11DGIPC	B18
ASF43G	B8	MSS2250RG	B22	SE1DGSMTTR	B11	TSS11DGIRA	B19
ASF43GL	B8	MSS4200	B22	SE1EGPC	B12	TSS11IDGPC	B18
ASF43GS	B9	MSS4200G	B22	SE1EGRA	B12	TSS11IDGIRA	B19
ASF43L	B8	MSS4200R	B23	SE1EGSMT	B11	TSS11IEGIPC	B18
ASF43R	B8	MSS4200RG	B23	SE1EGSMTTR	B11	TSS11IEGIRA	B19
ASF43RG	B8	MSS4250	B22	SE1GSM	B11	TSS11IEGPC	B18
ASF43RGL	B9	MSS4300	B23	SE1GSMTR	B11	TSS11IEGRA	B19
ASF43RGS	B9	MSS4300G	B23	SE2DGPC	B12	TSS21KGIPC	B18
ASF43RL	B9	MSS4300R	B24	SE2DGRA	B12	TSS21KGGPC	B18
ASF43RS	B9	MSS4300RG	B24	SE2EGPC	B12	TSS21NGIPC	B18
ASF43S	B9	MSS4335	B23	SE2EGRA	B12	TSS21NGIRA	B19
ASF62	B8	MSS4350R	B24	SL1000	B40	TSS21NGPC	B18
ASF62G	B8	MSS4350RG	B24	SL220	B40	TSS21NGRA	B19
ASF62GL	B8	MSS6200	B24	SL330	B40	TSS21PAGRA	B19
ASF62GS	B9	MSS6200G	B24	SL550	B40	TSS21PGIRA	B19
ASF62L	B8	MSS6250	B25	SL660	B40	TSS21PGPC	B18
ASF62R	B8	MSS6350	B25	SL770	B40	TSS21PGRA	B19
ASF62RG	B8	MSS6350G	B25	SL880	B40	TSS41NGPC	B18
ASF62RGL	B9	MSS6350R	B25	SLS120	B41	TSS41NGRA	B19
ASF62RGS	B9	MSS6350RG	B25	SLS1201	B42	1571490	B48
ASF62RL	B9			SLS121	B43	1571491	B48

B2

Slide Switch Selection Guide

PRODUCT LINE FEATURES

- One of the broadest lines in the industry.
- One to six pole configurations.
- Current ratings from 0.4V @ 20VDC to 3A @ 115VAC.
- Miniature and sub-miniature case sizes.
- Gold or silver plating available in most series.
- Wave solderable, washable, and surface mount versions.
- Rocker (butt), shoe and bifurcated contact mechanisms.
- Vertical and RA actuator styles.

CIRCUITRY	SERIES	TERMINATION	CONTACT RATING/PLATING	ACTION	LIFE EXPECTANCY
SPST	TSS	P.C.	.4VA/GOLD	STANDARD/FLUSH	80K CYCLES
SPDT	MHS	P.C./RIGHT ANGLE	.4VA/GOLD:300mA/SILVER	STANDARD/BATON	15K CYCLES
	MLL	SURFACE MOUNT	0.3A @ 4 VDC/SILVER	RIGHT ANGLE	10K CYCLES
	MMS	P.C.	100MA/SILVER	STANDARD	10K CYCLES
	MSS	P.C./RIGHT ANGLE	.4VA/GOLD:300MA/SILVER	STANDARD	15K CYCLES
	MSSA ^H H1	P.C./RIGHT ANGLE	.4VA/GOLD	STANDARD	30K CYCLES
	MSSA ^H H4	P.C./RIGHT ANGLE	3A/SILVER	STANDARD	30K CYCLES
	SDS	P.C./RIGHT ANGLE	300mA @ 125VAC/SILVER	STANDARD	10K CYCLES
	SE, S	P.C./RIGHT ANGLE/SMT	.4VA/GOLD	STANDARD	6K CYCLES
	SL	P.C.	250mA/SILVER	STANDARD	6K CYCLES
	SLS	P.C./RIGHT ANGLE	250mA/SILVER	STANDARD	6K CYCLES
	SLS/A	P.C.	500mA/SILVER	STANDARD	10K CYCLES
	SSA	P.C.	100mA/SILVER:.4VA/GOLD	STANDARD	10K CYCLES
	SSB	P.C./RIGHT ANGLE	100MA/SILVER:.4VA/GOLD	STANDARD	10K CYCLES
	SSJ	P.C./RIGHT ANGLE	100mA/SILVER	STANDARD	10K CYCLES
	STS	P.C./RIGHT ANGLE	300mA/SILVER	STANDARD	10K CYCLES
	TSS	P.C./RIGHT ANGLE	.4VA/GOLD	STANDARD/FLUSH	60-80K CYCLES
SP3T	MHS	P.C./RIGHT ANGLE	300MA/SILVER:.4VA/GOLD	STANDARD/BATON	15K CYCLES
	MLL	SURFACE MOUNT	0.3A @ 4 VDC/SILVER	RIGHT ANGLE	10K CYCLES
	MSS	P.C./RIGHT ANGLE	300mA/SILVER:.4VA/GOLD	STANDARD	15K CYCLES
	MSSA	P.C./RIGHT ANGLE	300MA/SILVER:.4VA/GOLD	STANDARD	15K CYCLES
	SDS	P.C./RIGHT ANGLE	300mA @ 125VAC/SILVER	STANDARD	10K CYCLES
	SL	P.C.	250mA/SILVER	STANDARD	6K CYCLES
	SLS	P.C./RIGHT ANGLE	250MA/SILVER	STANDARD	6K CYCLES
	SSJ	P.C.	100mA/SILVER	STANDARD	10K CYCLES
	STS	P.C./RIGHT ANGLE	300mA/SILVER	STANDARD	10K CYCLES
SP4T	MSS	P.C.	300mA/SILVER:.4VA/GOLD	STANDARD	15K CYCLES
	MSSA	P.C./RIGHT ANGLE	300mA/SILVER:.4VA/GOLD	STANDARD	15K CYCLES
	SLS	P.C./RIGHT ANGLE	250mA/SILVER	STANDARD	6K CYCLES
	STS	P.C./RIGHT ANGLE	300mA/SILVER	STANDARD	10K CYCLES
SP5T	SL	P.C.	250mA/SILVER	STANDARD	6K CYCLES
	SLS	P.C./RIGHT ANGLE	250mA/SILVER	STANDARD	6K CYCLES
	STS	P.C./RIGHT ANGLE	300mA/SILVER	STANDARD	10K CYCLES
SP6T	SL	P.C.	250mA/SILVER	STANDARD	6K CYCLES
	STS	P.C./RIGHT ANGLE	300mA/SILVER	STANDARD	10K CYCLES
SP7T	SL	P.C.	250mA/SILVER	STANDARD	6K CYCLES
SP8T	SL	P.C.	250mA/SILVER	STANDARD	6K CYCLES
SP10T	SL	P.C.	250mA/SILVER	STANDARD	6K CYCLES
DPST	TSS	P.C.	.4VA/GOLD	STANDARD/FLUSH	80K CYCLES
DPDT	ASE/F	P.C./RIGHT ANGLE/SMT	.4VA/GOLD:300mA SILVER	STANDARD/FLUSH	10K CYCLES
	CSS	P.C.	300mA/SILVER	BATON	15K CYCLES
	CST	P.C.	300mA/SILVER	BATON	15K CYCLES
	MHS	P.C./RIGHT ANGLE	300mA/SILVER:.4VA/GOLD	STANDARD/BATON	15K CYCLES
	MMS	P.C./RIGHT ANGLE	100mA/SILVER	STANDARD	10K CYCLES
	MSS	P.C./RIGHT ANGLE	300mA/SILVER:.4VA/GOLD	STANDARD	15K CYCLES
	MSSA21	P.C./RIGHT ANGLE	.4VA/GOLD	STANDARD	30K CYCLES

B

Slide Switches

Slide Switch Selection Guide

B
Slide Switches

CIRCUITRY	SERIES	TERMINATION	CONTACT RATING/PLATING	ACTUATION	LIFE EXPECTANCY	
DPDT	1571491	PANEL	6A/SILVER	STANDARD	5K CYCLES	
	MSSA2H4	P.C./RIGHT ANGLE	3A/SILVER	STANDARD/FLUSH	30K CYCLES	
	SDS	P.C./RIGHT ANGLE	300mA @ 125 VAC/SILVER	STANDARD	10K CYCLES	
	SE, S	P.C./RIGHT ANGLE	.4VA/GOLD	STANDARD	10K CYCLES	
	SLS	P.C.	250mA/SILVER	STANDARD	6K CYCLES	
	SLS/A	P.C.	500mA/SILVER	STANDARD	10K CYCLES	
	SSA	P.C.	100mA/SILVER:.4VA/GOLD	STANDARD	10K CYCLES	
	SSB	P.C./RIGHT ANGLE	100mA/SILVER:.4VA/GOLD	STANDARD	10K CYCLES	
	STS	P.C./RIGHT ANGLE	300 mA/SILVER	STANDARD	10K CYCLE	
	TSS	P.C./RIGHT ANGLE	.4VA/GOLD	STANDARD/FLUSH	60-80K CYCLES	
	DP3T	1571490	PANEL	13A/SILVER	STANDARD	5K CYCLES
		CST	P.C.	300mA/SILVER	BATON	10K CYCLES
		MHS	P.C./RIGHT ANGLE	300mA/SILVER:.4VA/GOLD	STANDARD/BATON	15KCYCLES
MMS		P.C./RIGHT ANGLE	100mA/SILVER	STANDARD	10K CYCLES	
MSSA		P.C./RIGHT ANGLE	300mA/SILVER:.4VA/GOLD	STANDARD	15K CYCLES	
SDS		P.C./RIGHT ANGLE	300mA @ 125 VAC	STANDARD	10K CYCLES	
SLS		P.C.	250mA/SILVER	STANDARD	6K CYCLES	
STS		P.C./RIGHT ANGLE	300mA/SILVER	STANDARD	10K CYCLES	
DP4T		MSS	P.C.	300mA/SILVER:.4VA/GOLD	STANDARD	15K CYCLES
		MSSA	P.C./RIGHT ANGLE	300mA/SILVER:.4VA/GOLD	STANDARD	15K CYCLES
		SLS	P.C.	250mA/SILVER	STANDARD	6K CYCLES
DP5T		STS	P.C./RIGHT ANGLE	300mA/SILVER	STANDARD	10K CYCLES
		SLS	P.C.	250mA/SILVER	STANDARD	6K CYCLES
DP6T	STS	P.C./RIGHT ANGLE	300mA/SILVER	STANDARD	10K CYCLES	
	SLS	P.C.	250mA/SILVER	STANDARD	6K CYCLES	
3P3T	MSSA	P.C./RIGHT ANGLE	300mA/SILVER: .4VA/GOLD	STANDARD	15K CYCLES	
	SSB	P.C.	100mA/SILVER:.4VA/GOLD	STANDARD	10K CYCLES	
	MSSA	P.C./RIGHT ANGLE	300mA/SILVER:.4VA/GOLD	STANDARD	15K CYCLES	
4PDT	ASE/F	P.C./RIGHT ANGLE/SMT	300mA/SILVER:.4VA/GOLD	STANDARD/FLUSH	10K CYCLES	
	CST	P.C.	300mA/SILVER	BATON	10K CYCLES	
	MMS	P.C./RIGHT ANGLE	100mA/SILVER	STANDARD	10K CYCLES	
	MSS	P.C./RIGHT ANGLE	300mA/SILVER:.4VA/GOLD	STANDARD	15K CYCLES	
	SSB	P.C.	100mA/SILVER:.4VA/GOLD	STANDARD	10K CYCLES	
	TSS	P.C./RIGHT ANGLE	.4VA/GOLD	STANDARD	80K CYCLES	
	ASE/F	P.C./RIGHT ANGLE/SMT	300mA/SILVER	STANDARD/FLUSH	10K CYCLES	
4P3T	CST	P.C.	300mA/SILVER	BATON	10K CYCLES	
	MHS	P.C.	300mA/SILVER:.4VA/GOLD	STANDARD	15K CYCLES	
	MMS	P.C./RIGHT ANGLE	100mA/SILVER	STANDARD	10K CYCLES	
	MSS/MSSA	P.C./RIGHT ANGLE	300mA/SILVER:.4VA/GOLD	STANDARD	15L CYCLES	
4P4T	MSSA	P.C./RIGHT ANGLE	300mA/SILVER:.4VA/GOLD	STANDARD	15K CYCLES	
6PDT	ASE/F	P.C./RIGHT ANGLE/SMT	300mA/SILVER:.4VA/GOLD	STANDARD/FLUSH	10K CYCLES	
	CST	P.C.	300mA/SILVER:.4VA/GOLD	BATON	10K CYCLES	
	MSS	P.C.	300mA/SILVER:.4VA/GOLD	STANDARD	15K CYCLES	
6P3T	MSS	P.C./RIGHT ANGLE	300mA/SILVER:.4VA/GOLD	STANDARD	15K CYCLES	

Slide Switches, Auto-insertable, Through Hole and Surface Mount

FEATURES:

- Unique design allows ASE/F to withstand aqueous or solvent cleaning processes.
- High temperature anti-static plastic construction will withstand most surface mount, vapor phase reflow or wave soldering conditions.
- Three standard types:
ASF – DIP package with flush actuator allows auto insertion on standard IC equipment. Standard tape seal and closed case construction provide process seal.

- ASFO–Open ended flush actuator without tape seal.
- ASE–extended actuator open-ended case allows washout after process cleaning.
- 2, 4 and 6 pole versions available with top or side actuator.
- Bifurcated double wipe contacts provide dependable, telecom grade switching.
- Industry standard .100 x .300 pin spacing

MATERIAL SPECIFICATIONS:

ContactsGold over nickel or
Silver over nickel flash
Case MaterialPET
Actuator MaterialNylon
Terminal.....Copper alloy, terminals tin lead plate
(90/10) over nickel

TYPICAL PERFORMANCE CHARACTERISTICS:

Contact RatingGold: 0.4 VA @ 20 VDC or peak AC shorting type
Silver: 300mA @ 115 VAC 28 VDC
Initial Contact Resistance40 Milliohms max.
Insulation Resistance1,000 Megohms @ 500 VDC min.
Dielectric Strength1,000 Volts RMS @ sea level
Contact TimingShorting
Life Expectancy10,000 Cycles
Actuation Force850g±150grams
Travel100 ±.010 [2.54±.25]

ENVIRONMENTAL SPECIFICATIONS:

Operating Temperature.....-40°F to +176°F (-40°C to +80°C)
Storage Temperature.....-40°F to +176°F (-40°C to +80°C)
Solder Heat ResistanceSee page M3-M4
Movable ContactCopper alloy
Terminal SealInsert molded

PART NUMBERING

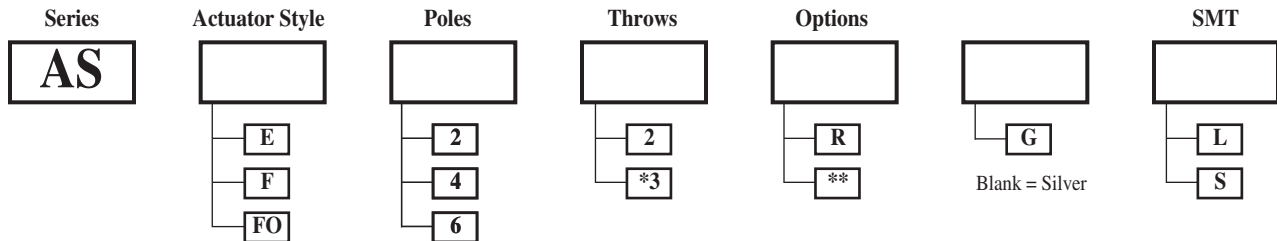

ASF: Tape seal, closed (sealed) case, flush top actuator.
ASE: Open ended case, extended top or side actuator.
ASFO: Open ended case, flush top or side actuator.

Standard actuator color is white.
E= Extended actuator
F= Flush actuator
FO= Open ended without tape seal
G= Gold contacts
R= Side actuator
*3= Throw available in 4 pole only
L= SMT terminal configuration
S= SMT terminal reverse L configuration (Refer to page B10 for pad layout)



ASE22R

ASE62G

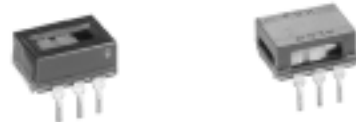

ASF22

ASF22R

**Flush side actuator "R" versions are supplied with open ended case and without tape seal.

Note: For SPDT requirements, order DPDT version and use either set of contacts for SPDT switching.

Slide Switches, Extended Actuator, Through Hole and Surface Mount

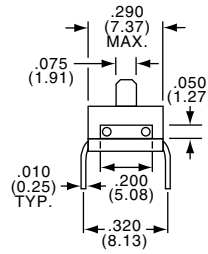
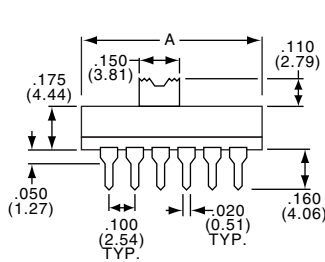
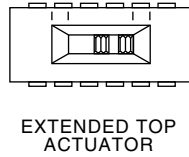

NOTE: See Page B10 for Circuit Diagram and Recommended PC Board Layout.

Upright, Through Hole, Extended Actuator

Tyco Electronics	Alcoswitch	Type	Contact	Dim A
1437581-2	ASE22	DPDT	Silver	.400/10.2
1437581-4	ASE22G	DPDT	Gold	.400/10.2
1-1437581-4	ASE42	4PDT	Silver	.700/17.8
1-1437581-6	ASE42G	4PDT	Gold	.700/17.8
2-1437581-5	ASE43	4P3T	Silver	1.10/27.9
2-1437581-6	ASE43G	4P3T	Gold	1.10/27.9
3-1437581-1	ASE62	6PDT	Silver	1.00/25.4
3-1437581-3	ASE62G	6PDT	Gold	1.00/25.4

EXTENDED SIDE ACTUATOR

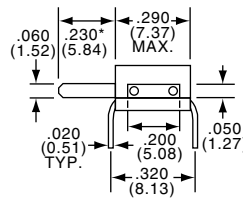
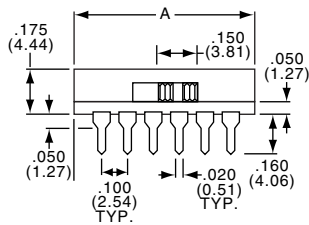
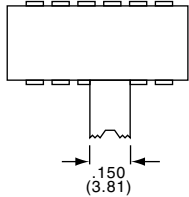

*.105 (2.67) ASE22R, ASE22RG

NOTE: See Page B10 for Circuit Diagram and Recommended PC Board Layout.

Right Angle, Through Hole, Extended Actuator

Tyco Electronics	Alcoswitch	Type	Contact	Dim A
1437581-8	ASE22R	DPDT	Silver	.400/10.2
1437581-9	ASE22RG	DPDT	Gold	.400/10.2
1-1437581-9	ASE42R	4PDT	Silver	.700/17.8
2-1437581-0	ASE42RG	4PDT	Gold	.700/17.8
2-1437581-9	ASE43R	4P3T	Silver	1.10/27.9
3-1437581-0	ASE43RG	4P3T	Gold	1.10/27.9
3-1437581-6	ASE62R	6PDT	Silver	1.00/25.4
3-1437581-7	ASE62RG	6PDT	Gold	1.00/25.4

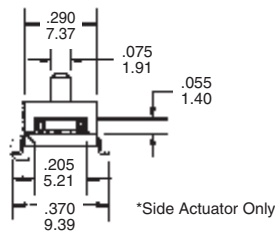
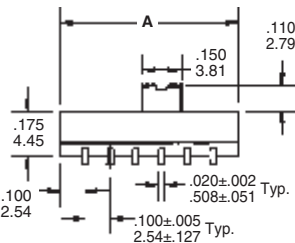
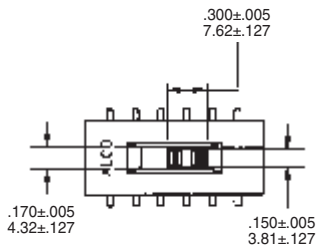

L Type Surface Mount

NOTE: See Page B10 for Circuit Diagram and Recommended PC Board Layout.

Upright, Surface Mount "L" Type, Extended Actuator

Tyco Electronics	Alcoswitch	Type	Contact	Dim A
1437581-5	ASE22GL	DPDT	Gold	.400/10.2
1437581-7	ASE22L	DPDT	Silver	.400/10.2
1-1437581-7	ASE42GL	4PDT	Gold	.700/17.8
1-1437581-8	ASE42L	4PDT	Silver	.700/17.8
2-1437581-7	ASE43GL	4P3T	Gold	1.10/27.9
2-1437581-8	ASE43L	4P3T	Silver	1.10/27.9
3-1437581-4	ASE62GL	6PDT	Gold	1.00/25.4
3-1437581-5	ASE62L	6PDT	Silver	1.00/25.4

Slide Switches, Extended Actuator, Through Hole and Surface Mount

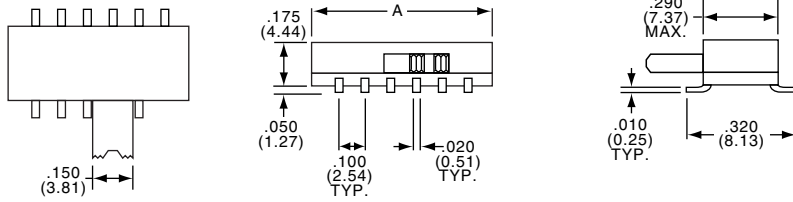

NOTE: See Page B10 for Circuit Diagram and Recommended PC Board Layout.

Right Angle, Surface Mount "L" Type, Extended Actuator

Tyco Electronics	Alcoswitch	Type	Contact	Dim A
—	ASE22RGL	DPDT	Gold	.400/10.2
1-1437581-1	ASE22RL	DPDT	Silver	.400/10.2
2-1437581-1	ASE42RGL	4PDT	Gold	.700/17.8
2-1437581-2	ASE42RL	4PDT	Silver	.700/17.8
—	ASE43RGL	4P3T	Gold	1.10/27.9
—	ASE43RL	4P3T	Silver	1.10/27.9
3-1437581-8	ASE62RGL	6PDT	Gold	1.00/25.4
3-1437581-9	ASE62RL	6PDT	Silver	1.00/25.4

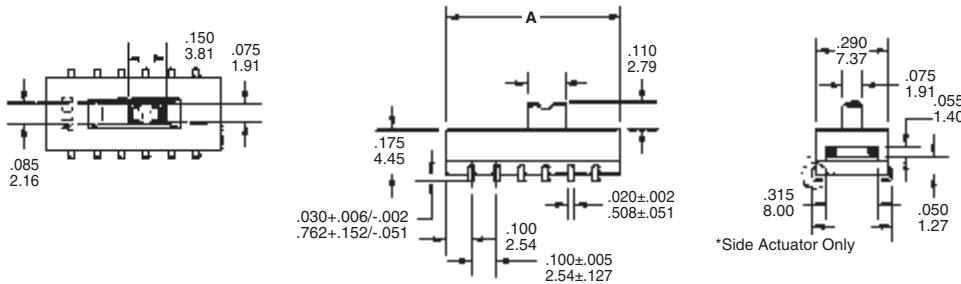

S Type Surface Mount

NOTE: See Page B10 for Circuit Diagram and Recommended PC Board Layout.

Upright, Surface Mount "S" Type, Extended Actuator

Tyco Electronics	Alcoswitch	Type	Contact	Dim A
1437581-6	ASE22GS	DPDT	Gold	.400/10.2
1-1437581-3	ASE22S	DPDT	Silver	.400/10.2
—	ASE42GS	4PDT	Gold	.700/17.8
2-1437581-4	ASE42S	4PDT	Silver	.700/17.8
—	ASE43GS	4P3T	Gold	1.10/27.9
—	ASE43S	4P3T	Silver	1.10/27.9
—	ASE62GS	6PDT	Gold	1.00/25.4
—	ASE62S	6PDT	Silver	1.00/25.4

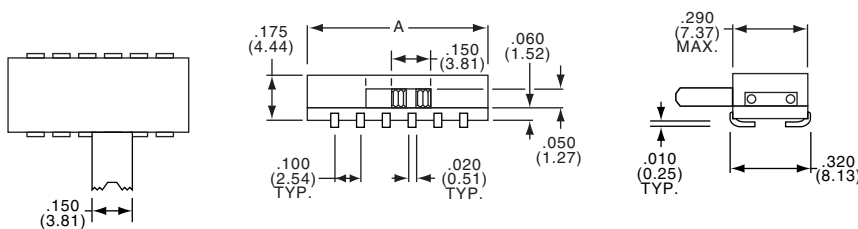

NOTE: See Page B10 for Circuit Diagram and Recommended PC Board Layout.

Right Angle, Surface Mount "S" Type, Extended Actuator

Tyco Electronics	Alcoswitch	Type	Contact	Dim A
1-1437581-0	ASE22RGS	DPDT	Gold	.400/10.2
1-1437581-2	ASE22RS	DPDT	Silver	.400/10.2
—	ASE42RGS	4PDT	Gold	.700/17.8
2-1437581-3	ASE42RS	4PDT	Silver	.700/17.8
—	ASE43RGS	4P3T	Gold	1.10/27.9
—	ASE43RS	4P3T	Silver	1.10/27.9
—	ASE62RGS	6PDT	Gold	1.00/25.4
—	ASE62RS	6PDT	Silver	1.00/25.4

Slide Switches, Flush Actuator, Through Hole and Surface Mount

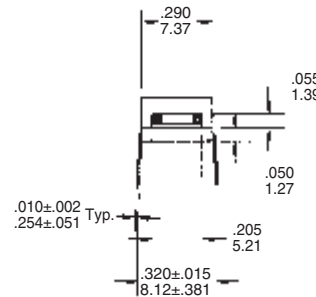
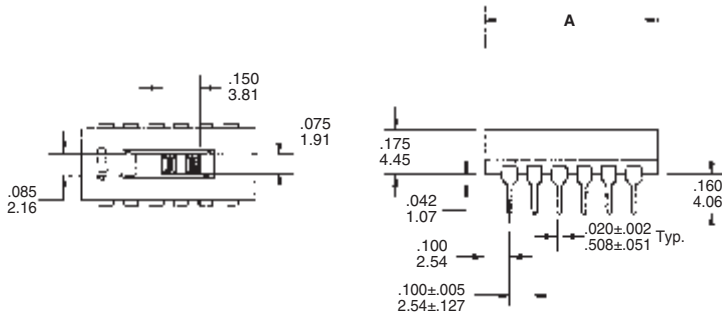

Upright, Through Hole, Flush Actuator

Tyco Electronics	Alcoswitch	Type	Contact	Dim A
5-1437581-6	ASF22	DPDT	Silver	.400/10.2
5-1437581-8	ASF22G	DPDT	Gold	.400/10.2
6-1437581-8	ASF42	4PDT	Silver	.700/17.8
7-1437581-0	ASF42G	4PDT	Gold	.700/17.8
7-1437581-8	ASF43	4P3T	Silver	1.10/27.9
7-1437581-9	ASF43G	4P3T	Gold	1.10/27.9
8-1437581-4	ASF62	6PDT	Silver	1.00/25.4
8-1437581-6	ASF62G	6PDT	Gold	1.00/25.4

NOTE: See Page B10 for Circuit Diagram and Recommended PC Board Layout.

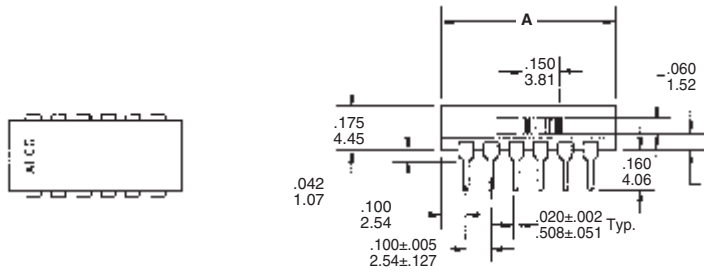

Right Angle, Through Hole, Flush Actuator

Tyco Electronics	Alcoswitch	Type	Contact	Dim A
6-1437581-2	ASF22R	DPDT	Silver	.400/10.2
6-1437581-3	ASF22RG	DPDT	Gold	.400/10.2
7-1437581-3	ASF42R	4PDT	Silver	.700/17.8
7-1437581-4	ASF42RG	4PDT	Gold	.700/17.8
	ASF43R	4P3T	Silver	1.10/27.9
8-1437581-2	ASF43RG	4P3T	Gold	1.10/27.9
8-1437581-9	ASF62R	6PDT	Silver	1.00/25.4
9-1437581-1	ASF62RG	6PDT	Gold	1.00/25.4

NOTE: See Page B10 for Circuit Diagram and Recommended PC Board Layout.

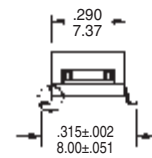
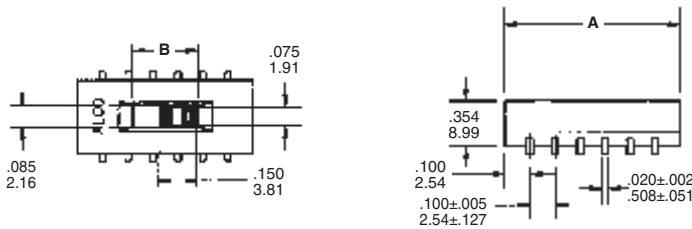

L Type Surface Mount

Upright, Surface Mount "L" Type, Flush Actuator

Tyco Electronics	Alcoswitch	Type	Contact	Dim A
5-1437581-9	ASF22GL	DPDT	Gold	.400/10.2
6-1437581-1	ASF22L	DPDT	Silver	.400/10.2
7-1437581-1	ASF42GL	4PDT	Gold	.700/17.8
7-1437581-2	ASF42L	4PDT	Silver	.700/17.8
8-1437581-0	ASF43GL	4P3T	Gold	1.10/27.9
8-1437581-1	ASF43L	4P3T	Silver	1.10/27.9
8-1437581-7	ASF62GL	6PDT	Gold	1.00/25.4
8-1437581-8	ASF62L	6PDT	Silver	1.00/25.4

NOTE: See Page B10 for Circuit Diagram and Recommended PC Board Layout.

Slide Switches, Flush Actuator, Through Hole and Surface Mount

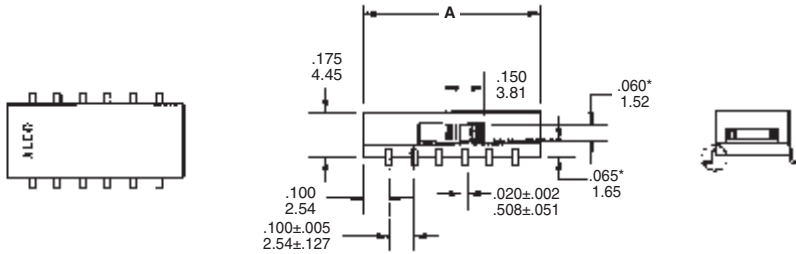

L Type Surface Mount

NOTE: See Page B10 for Circuit Diagram and Recommended PC Board Layout.

Right Angle, Surface Mount "L" Type, Flush Actuator

Tyco Electronics	Alcoswitch	Type	Contact	Dim A
6-1437581-4	ASF22RGL	DPDT	Gold	.400/10.2
—	ASF22RL	DPDT	Silver	.400/10.2
7-1437581-5	ASF42RGL	4PDT	Gold	.700/17.8
7-1437581-6	ASF42RL	4PDT	Silver	.700/17.8
—	ASF43RGL	4P3T	Gold	1.10/27.9
—	ASF43RL	4P3T	Silver	1.10/27.9
9-1437581-2	ASF62RGL	6PDT	Gold	1.00/25.4
—	ASF62RL	6PDT	Silver	1.00/25.4

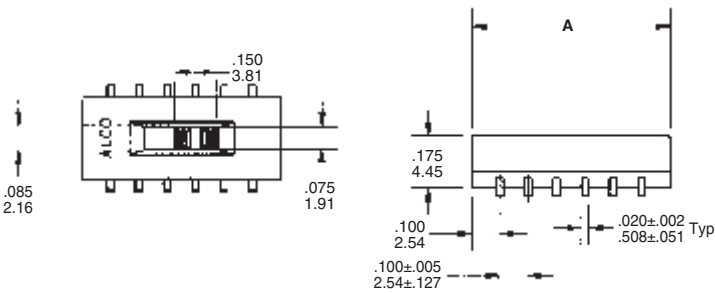

NOTE: See Page B10 for Circuit Diagram and Recommended PC Board Layout.

Upright, Surface Mount "S" Type, Flush Actuator

Tyco Electronics	Alcoswitch	Type	Contact	Dim A
6-1437581-0	ASF22GS	DPDT	Gold	.400/10.2
6-1437581-7	ASF22S	DPDT	Silver	.400/10.2
—	ASF42GS	4PDT	Gold	.700/17.8
7-1437581-7	ASF42S	4PDT	Silver	.700/17.8
—	ASF43GS	4P3T	Gold	1.10/27.9
8-1437581-3	ASF43S	4P3T	Silver	1.10/27.9
—	ASF62GS	6PDT	Gold	1.00/25.4
9-1437581-4	ASF62S	6PDT	Silver	1.00/25.4

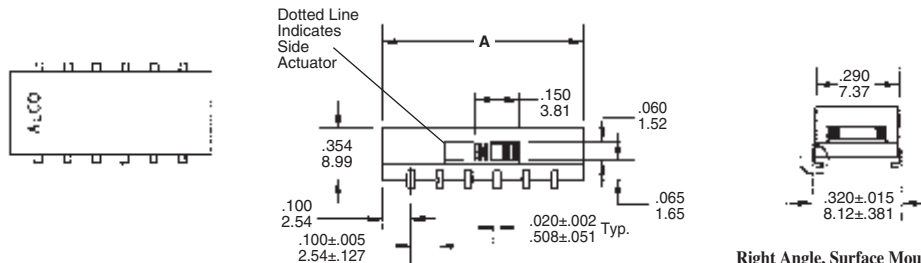

NOTE: See Page B10 for Circuit Diagram and Recommended PC Board Layout.

Right Angle, Surface Mount "S" Type, Flush Actuator

Tyco Electronics	Alcoswitch	Type	Contact	Dim A
6-1437581-5	ASF22RGS	DPDT	Gold	.400/10.2
6-1437581-6	ASF22RS	DPDT	Silver	.400/10.2
—	ASF42RGS	4PDT	Gold	.700/17.8
—	ASF42RS	4PDT	Silver	.700/17.8
—	ASF43RGS	4P3T	Gold	1.10/27.9
—	ASF43RS	4P3T	Silver	1.10/27.9
9-1437581-3	ASF62RGS	6PDT	Gold	1.00/25.4
—	ASF62RS	6PDT	Silver	1.00/25.4

Slide Switches, Auto-insertable, Through Hole and Surface Mount

CIRCUIT DIAGRAMS

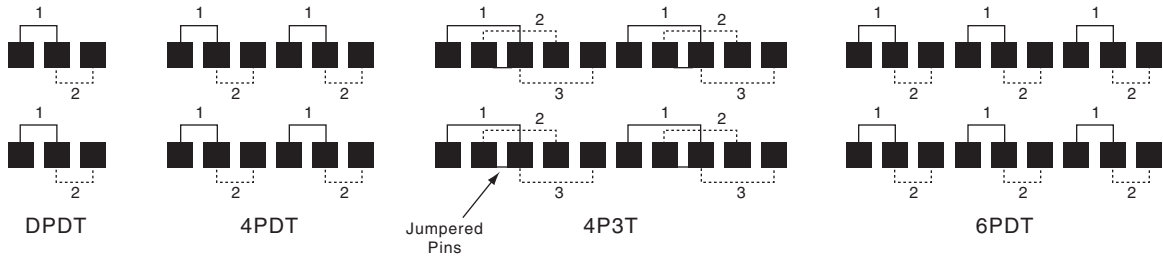

NOTE: For SPDT requirements order DPDT version and use either set of contacts for SPDT switching.

PC LAYOUT



PAD LAYOUT

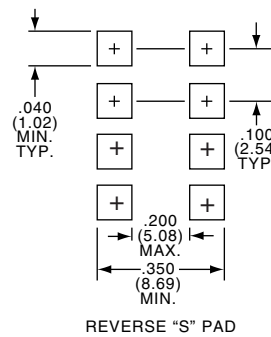
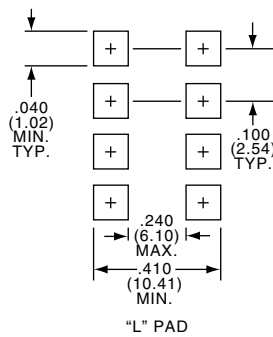

S Series Unsealed, SE Series Sealed, Through-Hole and Surface Mount

Product Facts

- n Sealed or Unsealed
- n Straight or Right-Angle
- n Through-hole or Surface-mount
- n Bulk or Tape-and-Reel packaged
- n Compact size
- n Double-pole function in a single-pole body
- n PC retention feature
- n High reliability contact system
- n Epoxy sealed base
- n Robust actuator for easy actuation
- n Non-shorting (break-before-make)

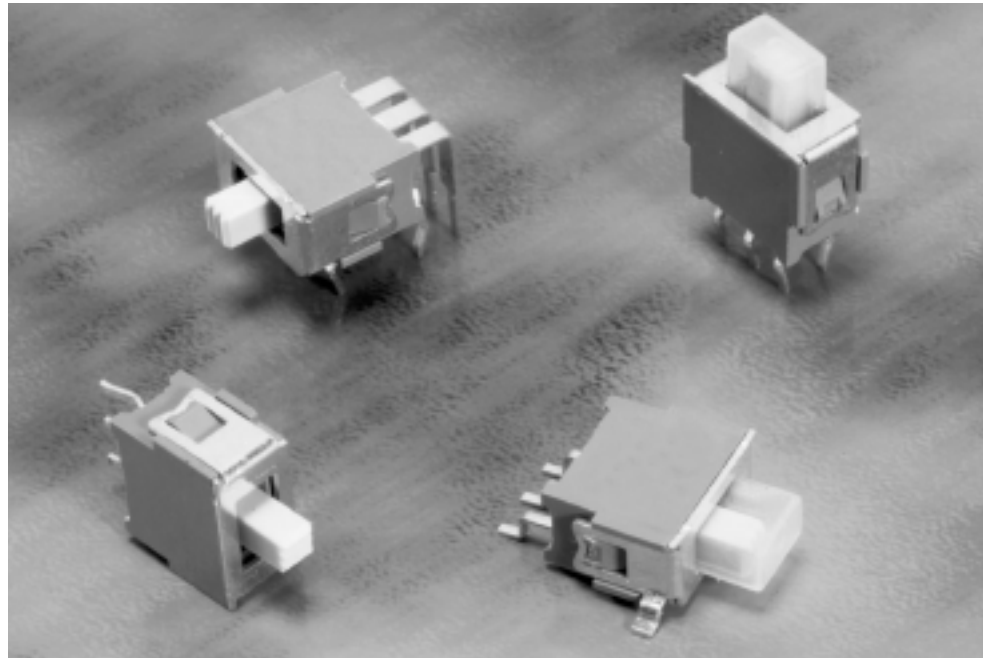

Switch, Slide, Surface Mount - SE1 SMT (Shown w/Boot)

Electrical Characteristics

Contact rating: .4 VA @ 20 VDC Max.
50mA 48V AC/DC
Min. 1 micro A 20 mV AC/DC

Initial Contact Resistance: less than 50 milliohms

Final Contact Resistance: 100 milliohms max.

Insulation Resistance: 500 Megaohms @ 250 VDC

Dielectric Strength: 500 VAC between terminals and ground

Mechanical

Mechanical Life: Up to 10,000 cycles @ max. load

Actuation Force: 70 to 500 grams

Materials and Finish

Terminals: Tin-lead over nickel-plated phosphor bronze

Contacts: Gold over nickel plated phosphor bronze

Frame: Tin over nickel plated brass

Case, Actuator, Plunger, Terminal Board: UL 94V-0 glass-filled Polyamide

Actuator Boot: Silicon Rubber

Standards & Specs

Sealed switch per IP 67

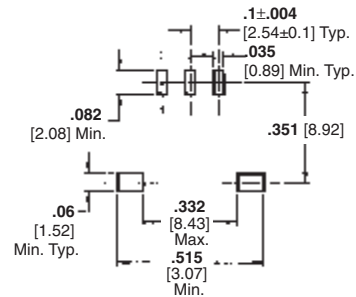
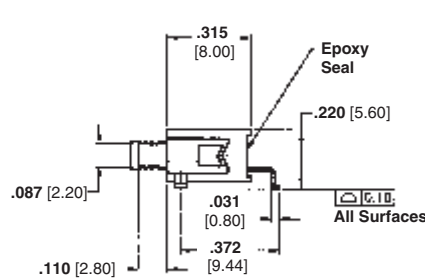
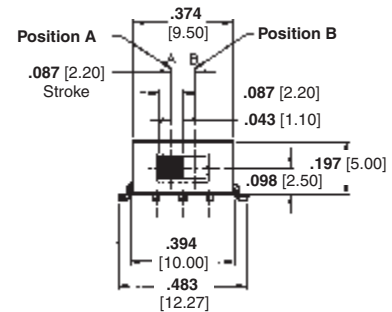
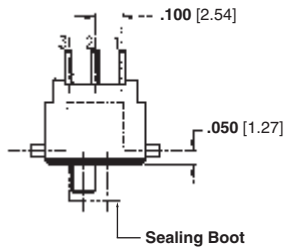

Recommended P.C.B. Pad Layout

SMT-Sealed Part Numbers

Tyco Electronics	Alcoswitch	Function
1571004-1	SE1GSMT	On-Off
1571004-2	SE1EGSMT	On-Off-On
1571004-3	SE1DGSMT	On-None-On

Tape & Reel Package

Tyco Electronics	Alcoswitch	Function
1571004-4	SE1GSMTTR	On-Off
1571004-5	SE1EGSMTTR	On-Off-On
1571004-6	SE1DGSMTTR	On-None-On

B
S/SE Series

Switch, Slide, PC Tail, S/SE GPC (Shown w/o Boot)

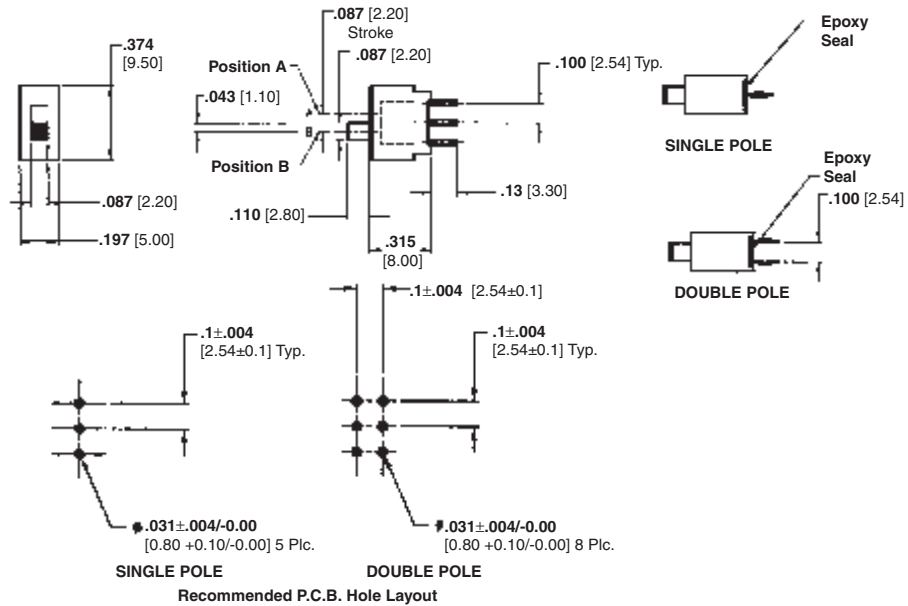

Sealed Part Numbers w/Boot

Tyco Electronics	Alcoswitch	Function
1437574-9	SE1DGPC	On-None-On
1-1437574-4	SE1EGPC	On-Off-On
1-1437574-6	SE2DGPC	On-None-On
2-1437574-0	SE2EGPC	On-Off-On

Unsealed Part Numbers w/o Boot

Tyco Electronics	Alcoswitch	Function
1571005-1	S1DGPC	On-None-On
1571005-2	S1EGPC	On-Off-On
1571005-3	S2DGPC	On-None-On
1571005-4	S2EGPC	On-Off-On

Switch, Slide, Right Angle, S/SE GRA (Shown w/o Boot)

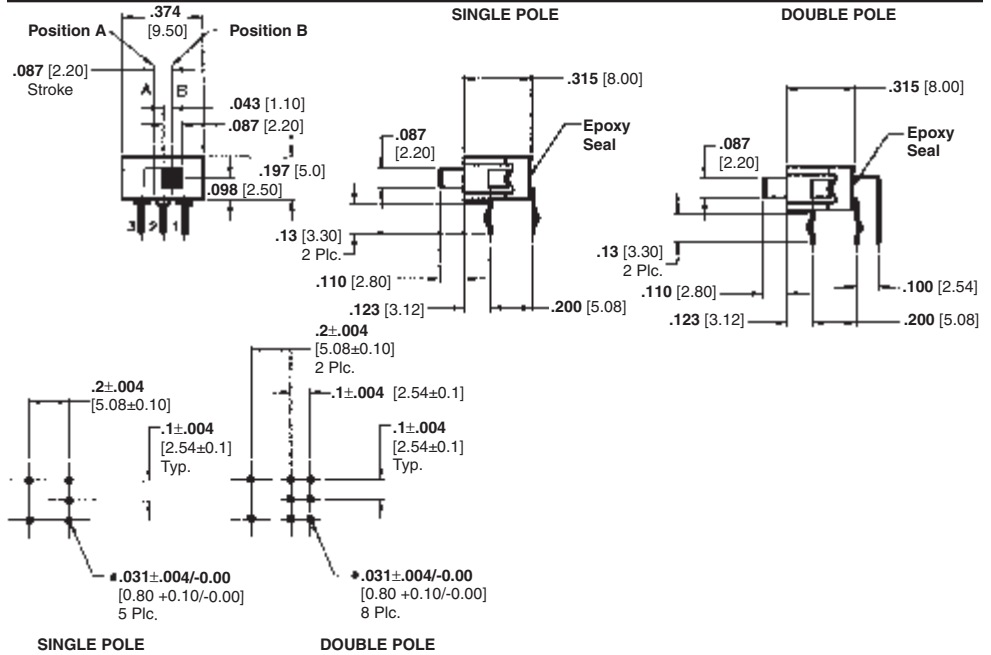

Sealed Part Numbers w/Boot

Tyco Electronics	Alcoswitch	Function
1-1437574-1	SE1DGRA	On-None-On
1-1437574-5	SE1EGRA	On-Off-On
1-1437574-8	SE2DGRA	On-None-On
2-1437574-1	SE2EGRA	On-Off-On

Unsealed Part Numbers w/o Boot

Tyco Electronics	Alcoswitch	Function
1571006-1	S1DGRA	On-None-On
1571006-2	S1EGRA	On-Off-On
1571006-3	S2DGRA	On-None-On
1571006-4	S2EGRA	On-Off-On

Slide Switches, Miniature, Low Profile, Economy Grade

MATERIAL SPECIFICATIONS:

ContactsSilver clad copper alloy
 Case MaterialSteel zinc plated
 Actuator MaterialPolyester (UL 94HB)
 Terminal SealEpoxy
 Terminals/Fixed ContactsSilver plate copper alloy

ENVIRONMENTAL SPECIFICATIONS:

Operating Temperature.....-5°F to 140°F (-15°C to +60°C)
 Storage Temperature.....-4°F to +158°F (-20°C to +70°C)
 Solder Heat ResistanceMIL-STD-202, Method 210

TYPICAL PERFORMANCE CHARACTERISTICS:

Contact Rating300 mA @ 125 VAC
 Initial Contact Resistance20 Milliohms max.
 Contact TimingMake-before-break
 Insulation Resistance100 Megohms min. @ 500 VDC
 Dielectric Strength500 VAC
 Actuation Force250 Grams, +150 Grams, -100 Grams
 Actuator Travel.....0.098" (2.49)
 Life ExpectancyUp to 10,000 Cycles

NOTICE: Bifurcated contact produces double wiping, self-cleaning contacts.

SPDT

Part Number			
Tyco Electronics	Alcoswitch	Plating	Mounting Style
5-1437577-8	STS121PC	Silver	Upright

SPDT

Part Number			
Tyco Electronics	Alcoswitch	Plating	Mounting Style
5-1437577-9	STS121RA	Silver	Right Angle

SP3T

Part Number			
Tyco Electronics	Alcoswitch	Plating	Mounting Style
6-1437577-2	STS131PC	Silver	Upright

SP3T

Part Number			
Tyco Electronics	Alcoswitch	Plating	Mounting Style
6-1437577-3	STS131RA	Silver	Right Angle

Slide Switches, Miniature, Low Profile, Economy Grade

SEE PAGE B13 FOR PRODUCT SPECIFICATIONS

SP3T



STS1300PC

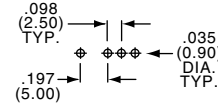
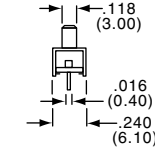
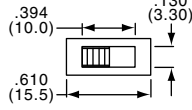
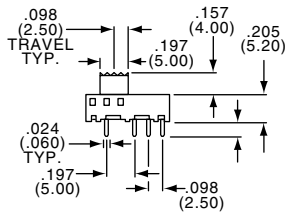

P. C. HOLE LAYOUT

SP3T



STS1300RA

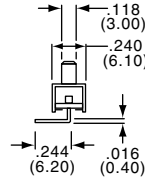
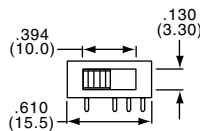

Part Number			
Tyco Electronics	Alcoswitch	Plating	Mounting Style
6-1437577-0	STS1300PC	Silver	Upright
6-1437577-1	STS1300RA	Silver	Right Angle

SP4T



STS1400PC

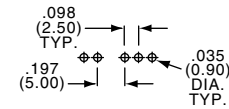
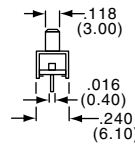
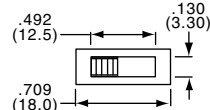
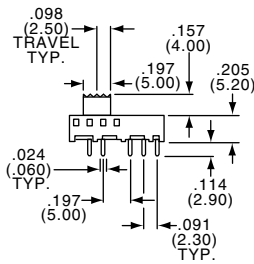

P. C. HOLE LAYOUT

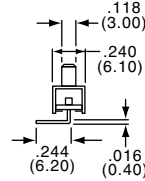
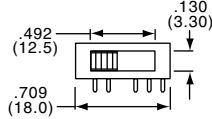

Part Number			
Tyco Electronics	Alcoswitch	Plating	Mounting Style
6-1437577-5	STS1400PC	Silver	Upright
6-1437577-6	STS1400RA	Silver	Right Angle

SP4T



STS141RA

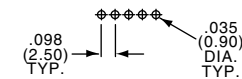
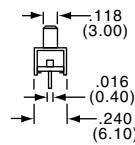
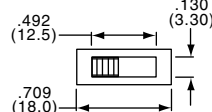
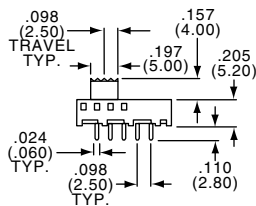

P. C. HOLE LAYOUT

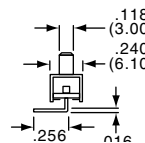
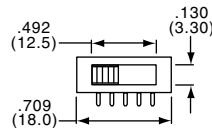

Part Number			
Tyco Electronics	Alcoswitch	Plating	Mounting Style
6-1437577-7	STS141PC	Silver	Upright
6-1437577-8	STS141RA	Silver	Right Angle

Slide Switches, Miniature, Low Profile, Economy Grade

SEE PAGE B13 FOR PRODUCT SPECIFICATIONS

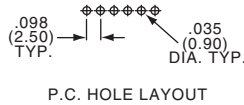

P.C. HOLE LAYOUT

Part Number			
Tyco Electronics	Alcoswitch	Plating	Mounting Style
6-1437577-9	STS151PC	Silver	Upright
7-1437577-0	STS151RA	Silver	Right Angle

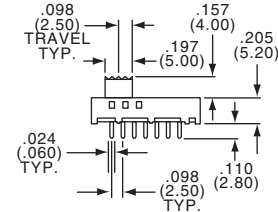
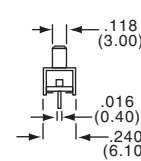
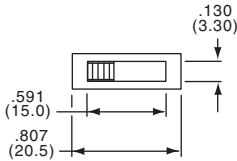

SP5T



STS151PC

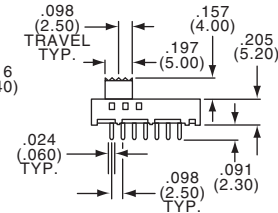
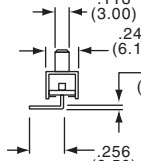
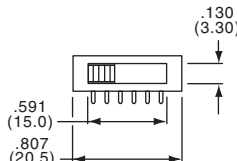

STS151RA

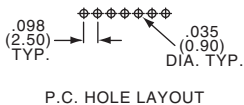

P.C. HOLE LAYOUT

Part Number			
Tyco Electronics	Alcoswitch	Plating	Mounting Style
7-1437577-1	STS161PC	Silver	Upright
7-1437577-2	STS161RA	Silver	Right Angle

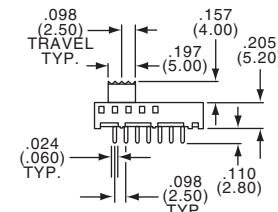
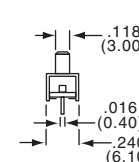
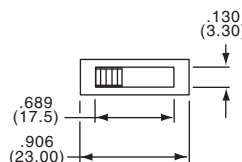

SP6T



STS161PC

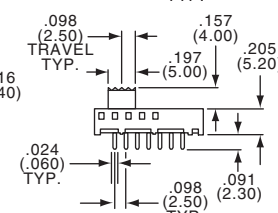
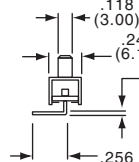
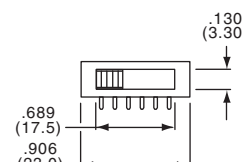

STS161RA

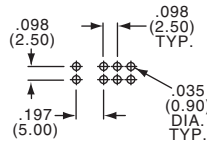

P. C. HOLE LAYOUT

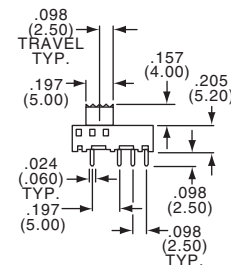
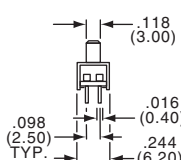
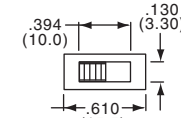

DP3T



STS2300PC

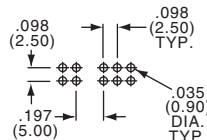

P. C. HOLE LAYOUT

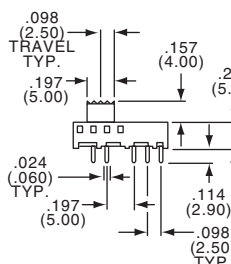
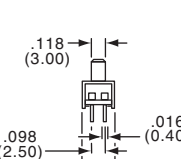
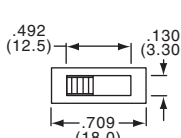

DP4T



STS2400PC

Part Number				
Tyco Electronics	Alcoswitch	Plating	Mounting Style	
7-1437577-4	STS2300PC	DP3T	Silver	Upright
7-1437577-6	STS2400PC	DP4T	Silver	Upright

Slide Switches, Miniature, Low Profile, Economy Grade

SEE PAGE B13 FOR PRODUCT SPECIFICATIONS

DPDT



STSA220RA

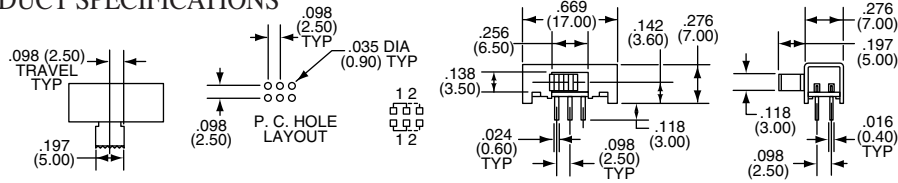

Part Number			
Tyco Electronics	Alcoswitch	Plating	Mounting Style
8-1437577-0	STSA220RA	Silver	Right Angle

DPDT



STSA220RA1

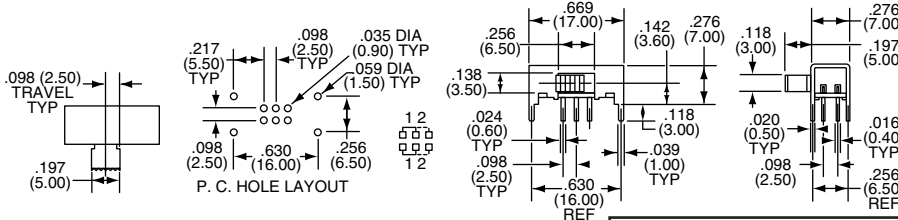

Part Number			
Tyco Electronics	Alcoswitch	Plating	Mounting Style
8-1437577-1	STSA220RA1	Silver	Right Angle

DP3T



STSA230RA

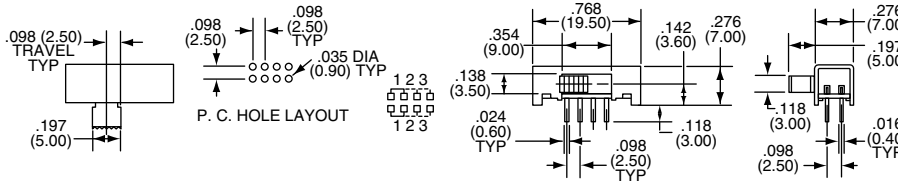

Part Number			
Tyco Electronics	Alcoswitch	Plating	Mounting Style
8-1437577-2	STSA230RA	Silver	Right Angle

DP3T



STSA230RA1

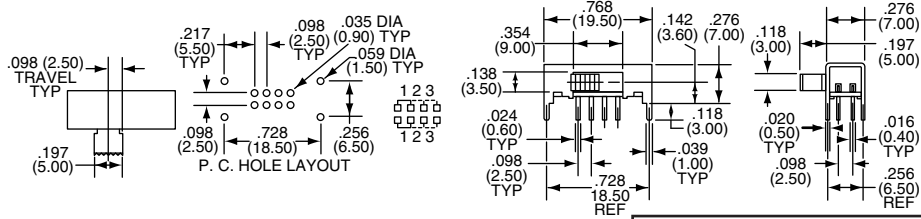

Part Number			
Tyco Electronics	Alcoswitch	Plating	Mounting Style
8-1437577-3	STSA230RA1	Silver	Right Angle

DP6T/DP5T/DP4T/
DP3T/DP2T



STS220PC

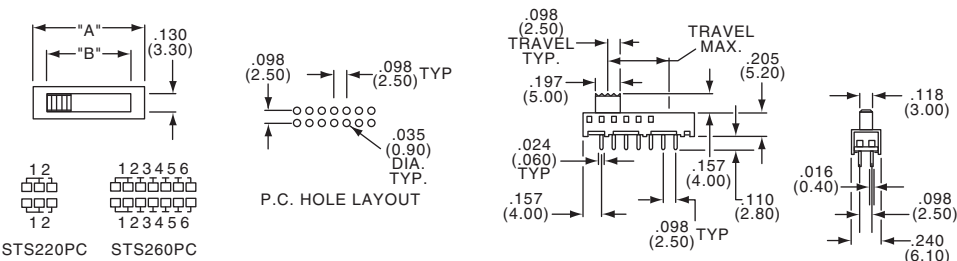

Part Number						Part Number						
Tyco Electronics	Alcoswitch	Type	Dim.A	Dim.B	Travel Max.	Tyco Electronics	Alcoswitch	Type	Dim.A	Dim.B	Travel Max.	Pin Holes
7-1437577-3	STS220PC	DP2T	.512(13.0)	.295(7.50)	.098(2.50)	7-1437577-8	STS250PC	DP5T	.807(20.5)	.591(15.0)	.394(10.0)	12
7-1437577-5	STS230PC	DP3T	.610(15.5)	.394(10.0)	.197(5.00)	7-1437577-9	STS260PC	DP6T	.906(23.0)	.689(17.5)	.492(12.5)	14
7-1437577-7	STS240PC	DP4T	.709(18.0)	.492(12.5)	.295(7.50)							

B STS/STSA Series

Slide Switches, Instrument Grade, Decorative

MATERIAL SPECIFICATIONS:

ContactsSilver clad copper alloy
 Case MaterialSteel, tin plated
 Actuator MaterialPolycarbonate
 Terminals/Fixed ContactsSilver over nickel
 Terminal SealEpoxy

TYPICAL PERFORMANCE CHARACTERISTICS:

Contact Rating300 mA @ 125 VAC
 Initial Contact Resistance20 Milliohms max.
 Insulation Resistance1,000 Megohms min. @ 500 VDC
 Dielectric Strength500 VAC
 Actuation Force0.250 Grams, +200/-150
 Plunger/Actuator Travel0.079" (2.01)
 Life ExpectancyUp to 10,000 Cycles

ENVIRONMENTAL SPECIFICATIONS:

Operating Temperature.....-14°F to +140°F (-10°C to +60°C)
 Storage Temperature.....-14°F to +140°F (-10°C to +60°C)
 Solder Heat Resistance.....MIL-STD-202, Method 210

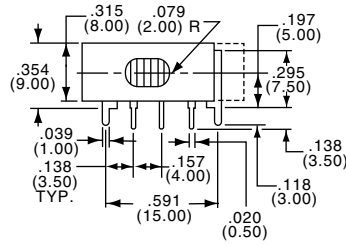
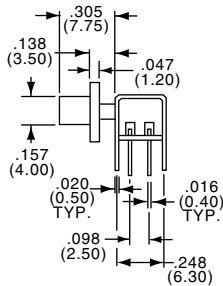
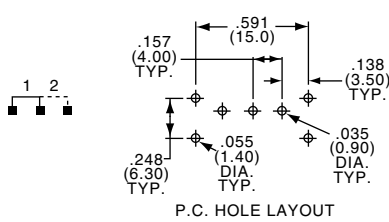

SPDT/DPDT



SDS2240RA0

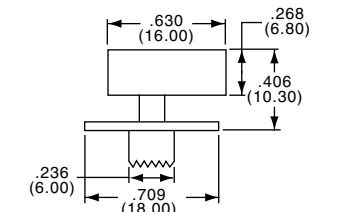
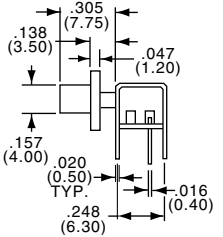
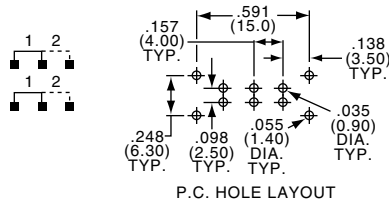

Part Number				Part Number			
Tyco Electronics	Alcoswitch	Type	Actuator Color	Tyco Electronics	Alcoswitch	Type	Actuator Color
1437577-2	SDS1240RA0	SPDT	Black	1437577-6	SDS2240RA0	DPDT	Black
1437577-3	SDS1240RA8	SPDT	Gray	—	SDS2240RA8	DPDT	Gray

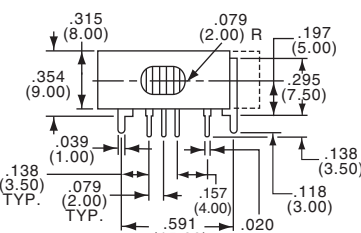
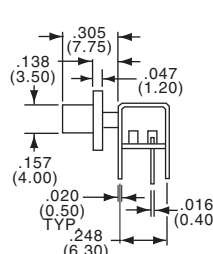
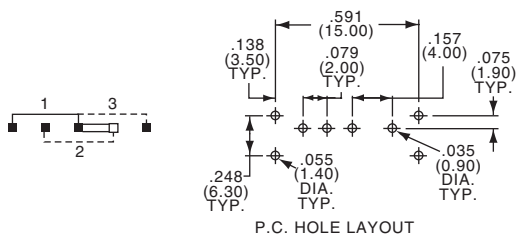

SP3T/DP3T



SDS1340RA8

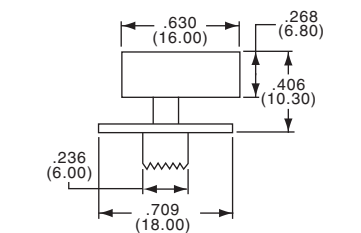
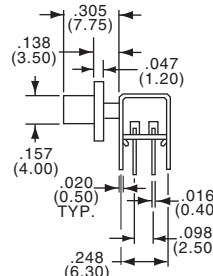
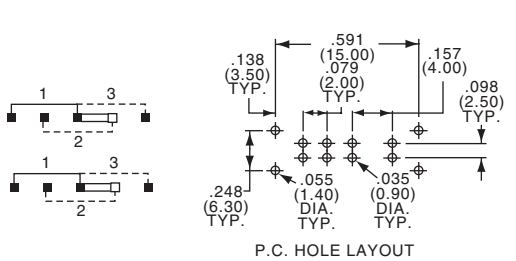

Part Number				Part Number			
Tyco Electronics	Alcoswitch	Type	Actuator Color	Tyco Electronics	Alcoswitch	Type	Actuator Color
1437577-4	SDS1340RA0	SP3T	Black	1437577-7	SDS2340RA0	DP3T	Black
1437577-5	SDS1340RA8	SP3T	Gray	—	SDS2340RA8	DP3T	Gray

Slide Switches, Vertical, Single or Dual Actuator

MATERIAL SPECIFICATIONS:

ContactsCopper w/gold plate over nickel
 Case MaterialHigh temperature polyester (94-VO)
 Actuator MaterialPolyester (94-VO)
 TerminalsCopper alloy tin/lead/nickel or gold/nickel
 Terminal SealEpoxy standard: single pole, optional: double pole

TYPICAL PERFORMANCE CHARACTERISTICS:

Contact RatingGold: 0.4 VA max. @ 20 VDC or peak AC
 Initial Contact Resistance20 Milliohms max.
 Contact TimingNon-shorting
 Insulation Resistance1,000 Megohms min. @ 500 VDC
 Dielectric Strength1,000 Volts RMS @ sea level
 Plunger/Actuator Travel0.120" (3.05)
 Life ExpectancyUp to 60,000-80,000 Cycles

ENVIRONMENTAL SPECIFICATIONS:

Operating Temperature-4°F to + 176°F (-20°C to + 80°C)
 Storage Temperature-4°F to + 176°F (-20°C to + 80°C)

SPST/SPDT

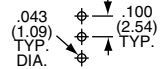
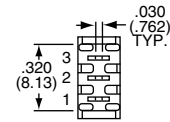
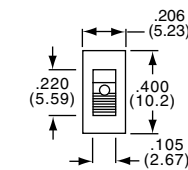
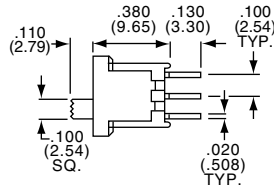

SPST/SPDT (DUAL)

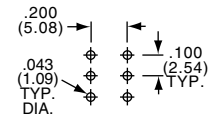
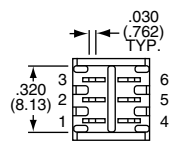
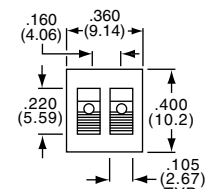
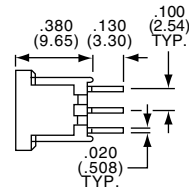

Extended Actuator Tyco Electronics	Alcoswitch	Type	Act. Code P. M6	On	None	Off	Extended Dual Actuator Tyco Electronics	Alcoswitch	Type	Act. Code P. M6	On	None	Off
1437578-3	TSS11AGPC	SPST	A	On	None	Off	—	TSD21AAGPC	2 x SPST	A	On	None	Off
1-1437589-0	TSS11DGPC	SPDT	D	On	None	On	1437579-5	TSD21DDGPC	2 x SPDT	D	On	None	On
1-1437579-4	TSS11EGPC	SPDT	E	On	Off	On	Flush Dual Actuator						
—	TSS11AG1PC	SPST	A	On	None	Off	—	TSD21DDG1PC	2 x SPDT	D	On	None	On
1437579-8	TSS11DG1PC	SPDT	D	On	None	On							
1-1437579-2	TSS11EG1PC	SPDT	E	On	Off	On							

Note: No center terminals on "A" action switches.

DPST/DPDT

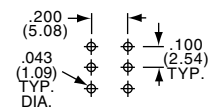
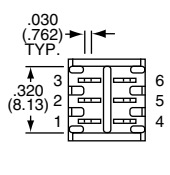
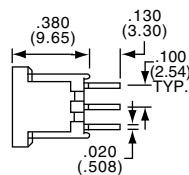
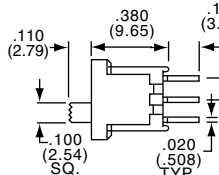
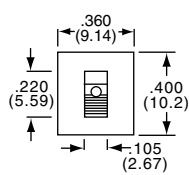

Extended Actuator Tyco Electronics	Alcoswitch	Type	Act. Code P. M6	On	None	Off	Flush Actuator Tyco Electronics	Alcoswitch	Act. Code Type	P. M6	On	None	Off
1-1437579-6	TSS21KGPC	DPST	K	On	None	Off	—	TSS21KG1PC	DPST	K	On	None	Off
1-1437579-9	TSS21NGPC	DPDT	N	On	None	On	1-1437579-7	TSS21NG1PC	DPDT	N	On	None	On
2-1437579-3	TSS21PGPC	DPDT	P	On	Off	On	2-1437579-1	TSD21RG1PC	DPDT	P	On	Off	On

Note: No center terminals on "K" action switches.

4PDT

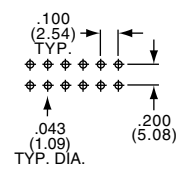
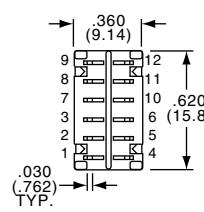
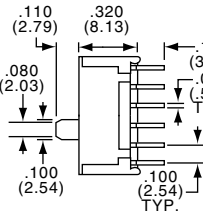
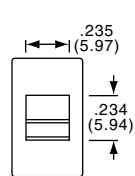

Extended Actuator Tyco Electronics	Alcoswitch	Type	Act. Code P. M6	On	None	Off
2-1437579-5	TSS41NGPC	4PDT	N	On	None	On

Slide Switches, Right Angle, Single or Dual Actuator

SEE PAGE B18 FOR PRODUCT SPECIFICATIONS

SPDT

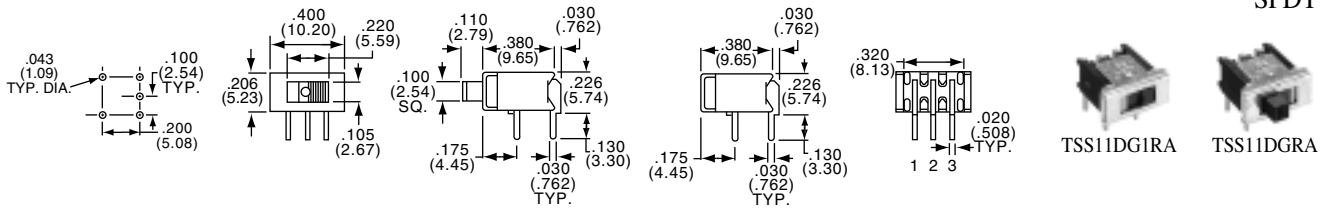

Extended Actuator			Act. Code			Flush Actuator			Act. Code			
Tyco Electronics	Alcoswitch	Type	P. M6	On	None	Tyco Electronics	Alcoswitch	Type	P. M6	On	None	On
1-1437579-1	TSS11DGRA	SPDT	D	On	None	1437579-9	TSS11DG1RA	SPDT	D	On	None	On
1-1437579-5	TSS11EGRA	SPDT	E	On	Off	1-1437579-3	TSS11EG1RA	SPDT	E	On	Off	On

SPDT (DUAL)

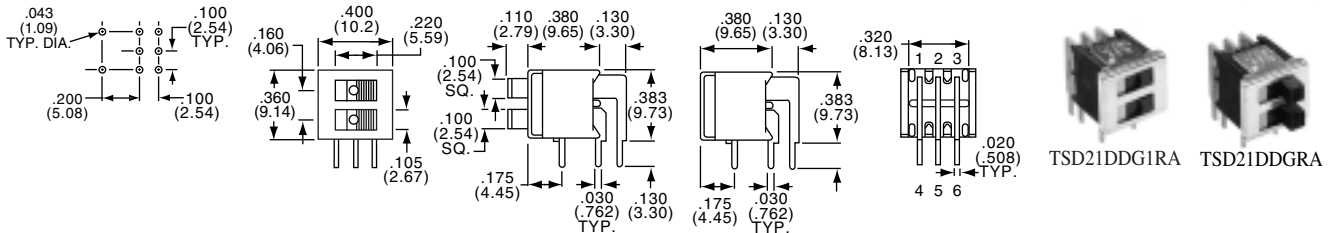

Extended Actuator			Act. Code			Flush Actuator			Act. Code			
Tyco Electronics	Alcoswitch	Type	P. M6	On	None	Tyco Electronics	Alcoswitch	Type	P. M6	On	None	On
1437579-6	TSD21DDGRA	2 x SPDT	D	On	None	1437579-4	TSD21DDG1RA	2 x SPDT	D	On	None	On
1437579-7	TSD21EEGRA	2 x SPDT	E	On	Off	—	TSD21EEG1RA	2 x SPDT	E	On	Off	On

DPDT

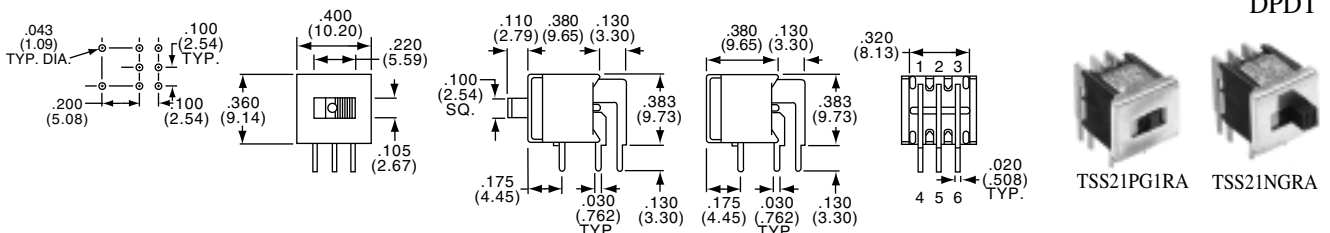

Extended Actuator			Act. Code			Flush Actuator			Act. Code			
Tyco Electronics	Alcoswitch	Type	P. M6	On	None	Tyco Electronics	Alcoswitch	Type	P. M6	On	None	On
—	TSS21PAGRA	SP3T	PA	On	On	—	TSS21NG1RA	DPDT	N	On	None	On
2-1437579-0	TSS21NGRA	DPDT	N	On	None	—	TSS21PG1RA	DPDT	P	On	Off	On
2-1437579-4	TSS21PGRA	DPDT	P	On	Off	—	—	—	—	—	—	—

4PDT

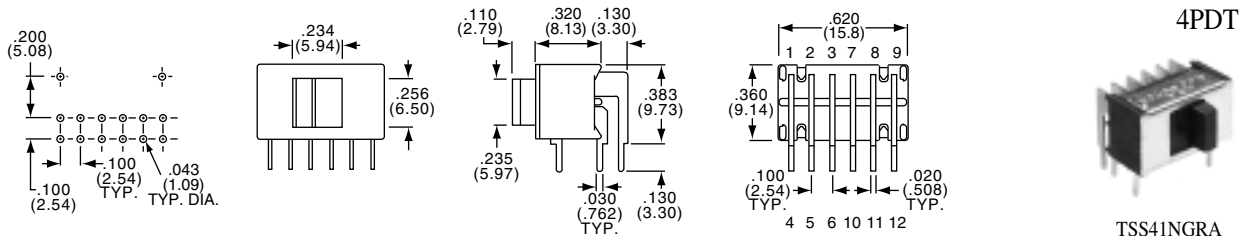

Extended Actuator			Act. Code			
Tyco Electronics	Alcoswitch	Type	P. M6	On	None	On
2-1437579-7	TSS41NGRA	4PDT	N	On	None	On

Slide Switches, Instrumentation Grade

MATERIAL SPECIFICATIONS:

ContactsGold or silver over nickel/copper alloy
 Frame MaterialTin plated steel
 Terminals/Fixed Contacts.....Gold or silver over nickel/over copper alloy
 Terminal SealEpoxy
 Actuator MaterialPOM-UL94HB

ENVIRONMENTAL SPECIFICATIONS:

Operating Temperature.....-4°F to +185°F (-20°C to +85°C)
 Storage Temperature.....-40°F to +212°F (-40°C to +100°C)
 Solder Heat ResistanceSee page M3-4

TYPICAL PERFORMANCE CHARACTERISTICS:

Contact RatingGold: 0.4 VA 20 VDC or peak AC
 Silver: 300 mA @ 125 VAC
 Initial Contact Resistance20 Milliohms max.
 Contact TimingMake before break
 Insulation Resistance1,000 Megohms min.
 Dielectric Strength500 VAC
 Actuation Force100 to 600 Grams
 Life ExpectancyUp to 15,000 Cycles
 Travel0.079" (2.01) (unless otherwise specified)

B
MSS Series

SPDT



MSS1200

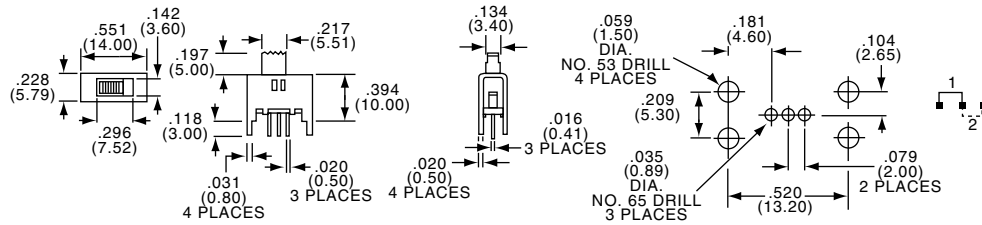

MSS1200R

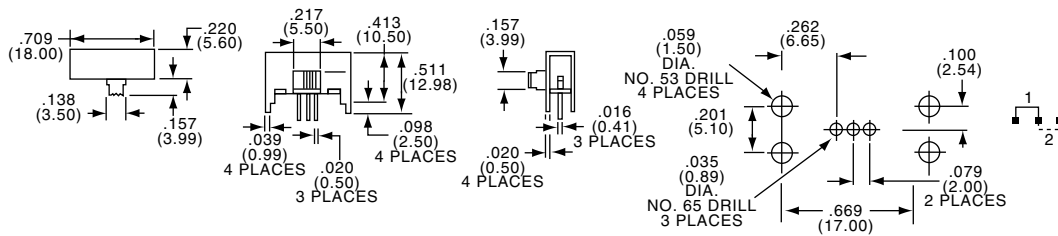

Tyco Electronics	Alcoswitch	Plating	Tyco Electronics	Alcoswitch	Plating
5-1437576-0	MSS1200	Silver	5-1437576-2	MSS1200R	Silver
5-1437576-1	MSS1200G	Gold	5-1437576-3	MSS1200RG	Gold

SP3T



MSS1300

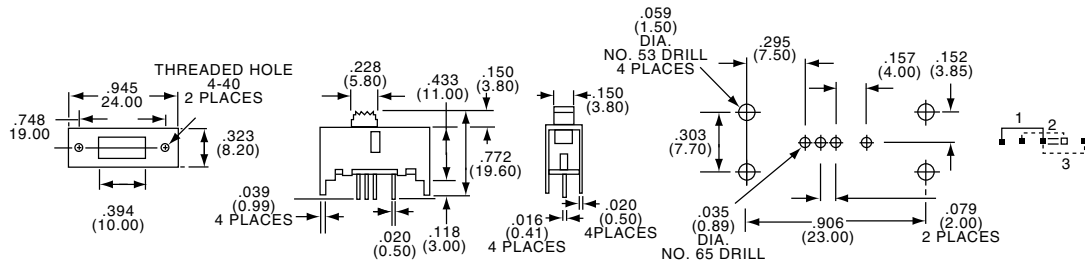

MSS1300R

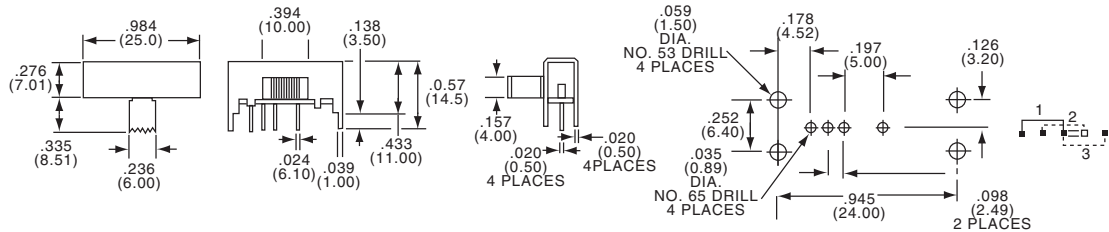

Tyco Electronics	Alcoswitch	Plating	Tyco Electronics	Alcoswitch	Plating	Total Actuator Travel
5-1437576-4	MSS1300	Silver	5-1437576-6	MSS1300R	Silver	.098(2.50)
5-1437576-5	MSS1300G	Gold	5-1437576-7	MSS1300RG	Gold	.098(2.50)

Slide Switches, Instrumentation Grade

SEE PAGE B20 FOR PRODUCT SPECIFICATIONS

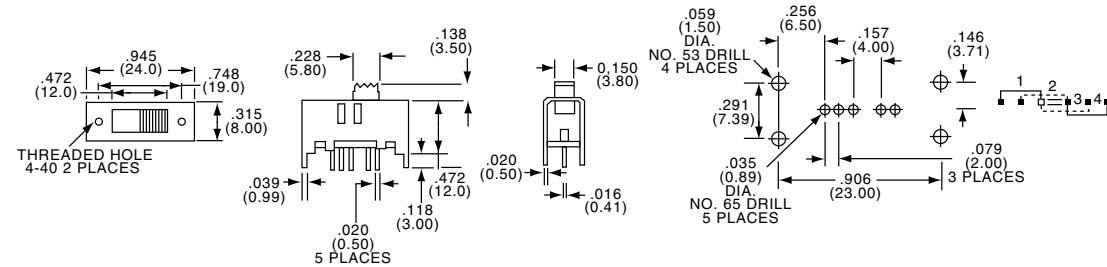

Tyco Electronics	Alcoswitch	Plating
5-1437576-8	MSS1400	Silver
1571423-1	MSS1400G	Gold

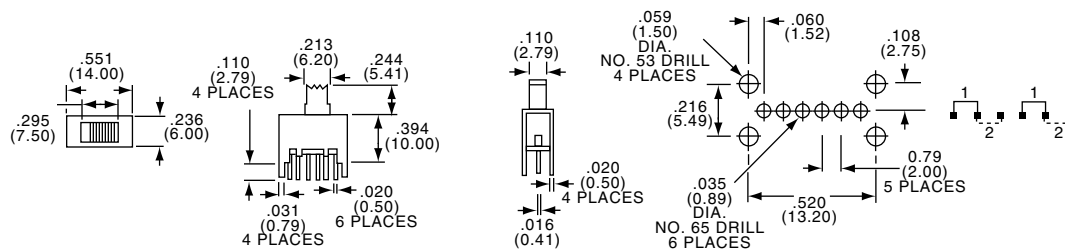

Tyco Electronics	Alcoswitch	Plating
6-1437576-3	MSS2225	Silver
6-1437576-4	MSS2225G	Gold

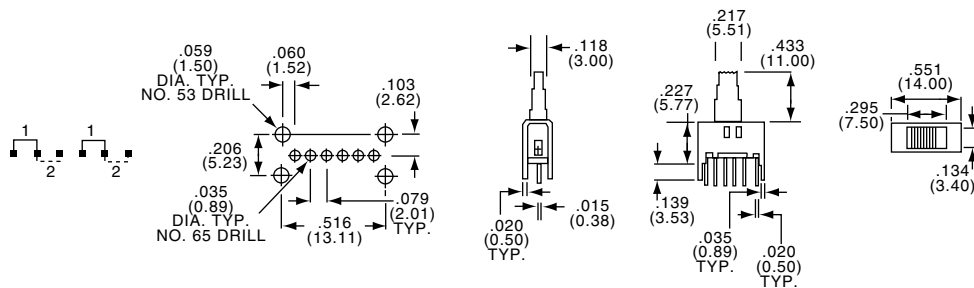

Tyco Electronics	Alcoswitch	Plating
6-1437576-5	MSS2250	Silver
6-1437576-6	MSS2250G	Gold

Slide Switches, Instrumentation Grade

SEE PAGE B20 FOR PRODUCT SPECIFICATIONS

DPDT



MSS2250R

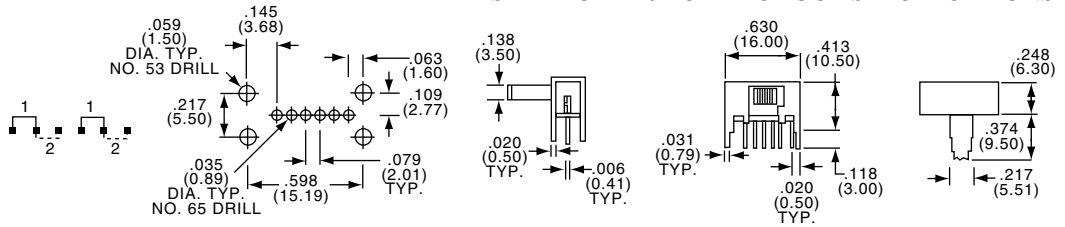

Tyco Electronics	Alcoswitch	Plating
6-1437576-7	MSS2250R	Silver
6-1437576-8	MSS2250RG	Gold

4PDT



MSS4200

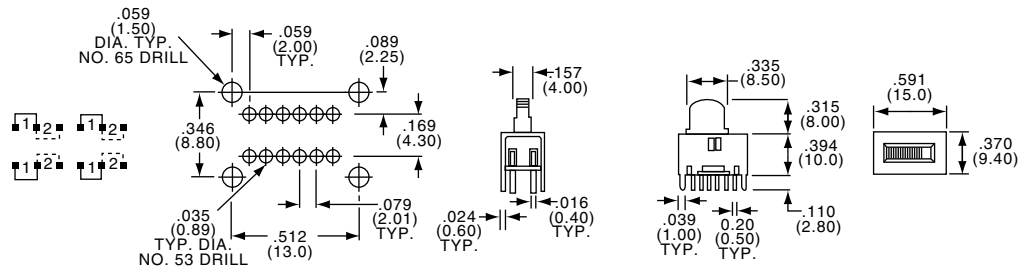

Tyco Electronics	Alcoswitch	Plating
6-1437576-9	MSS4200	Silver
7-1437576-0	MSS4200G	Gold

4PDT



MSS4250

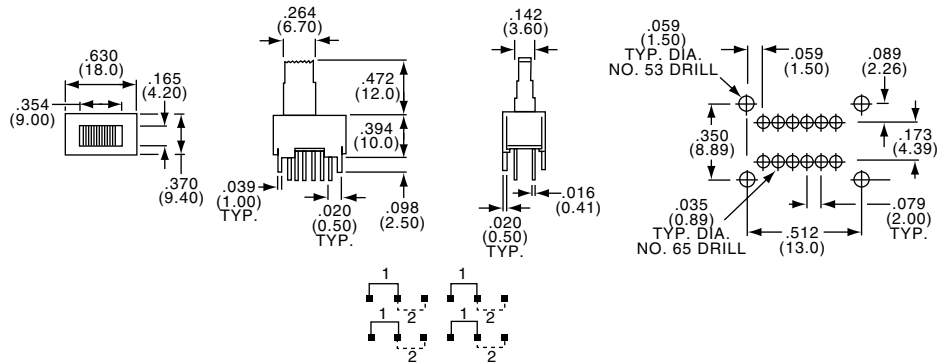

Tyco Electronics	Alcoswitch	Plating
7-1437576-4	MSS4250	Silver

B
MSS Series

Slide Switches, Instrumentation Grade

SEE PAGE B20 FOR PRODUCT SPECIFICATIONS

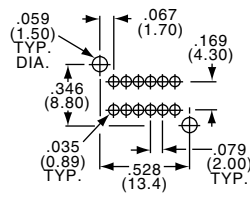
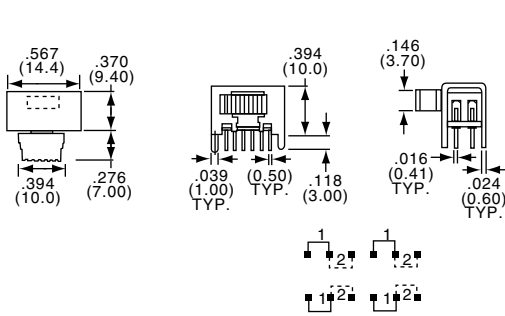

Tyco Electronics	Alcoswitch	Plating
7-1437576-2	MSS4200R	Silver
7-1437576-3	MSS4200RG	Gold

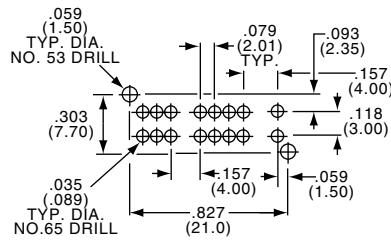
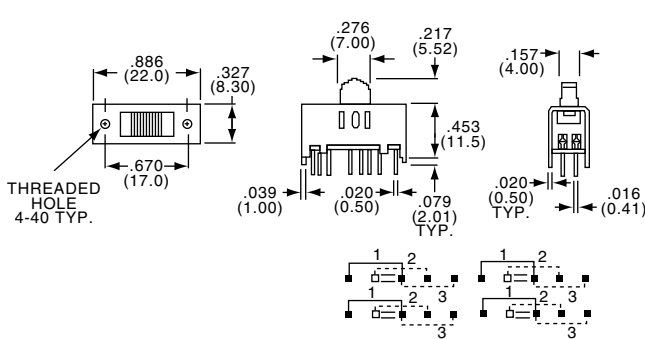

Tyco Electronics	Alcoswitch	Plating
7-1437576-5	MSS4300	Silver
7-1437576-6	MSS4300G	Gold

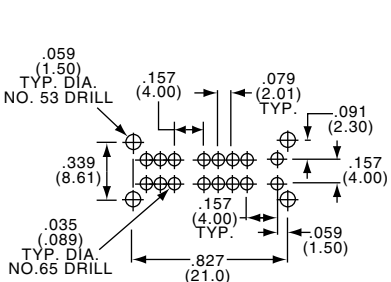
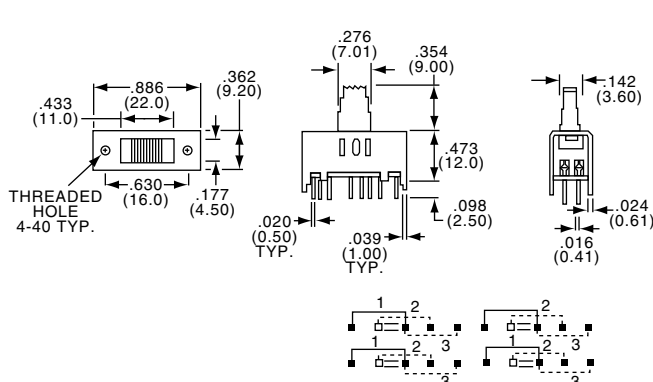

Tyco Electronics	Alcoswitch	Plating
7-1437576-9	MSS4335	Silver

Slide Switches, Instrumentation Grade

SEE PAGE B20 FOR PRODUCT SPECIFICATIONS

4P3T



MSS4300R

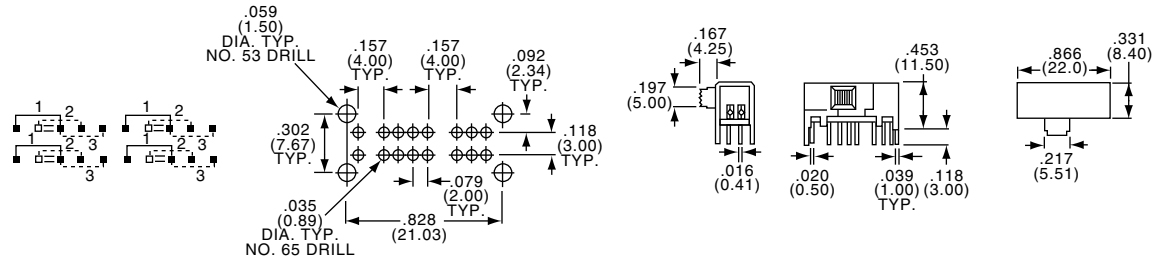

Tyco Electronics	Alcoswitch	Plating
7-1437576-7	MSS4300R	Silver
7-1437576-8	MSS4300RG	Gold

4P3T



MSS4350R

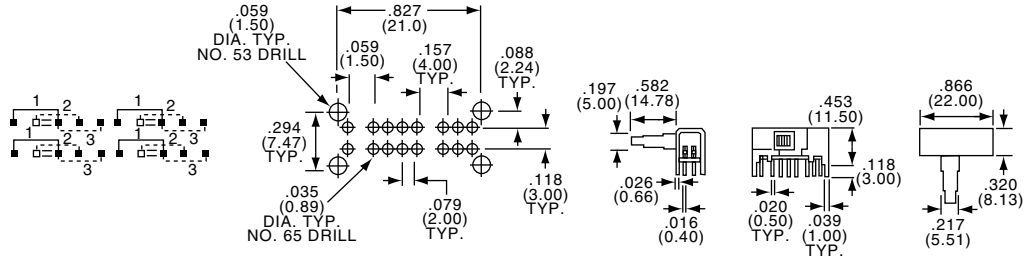

Tyco Electronics	Alcoswitch	Plating
8-1437576-0	MSS4350R	Silver
8-1437576-1	MSS4350RG	Gold

6PDT



MSS6200

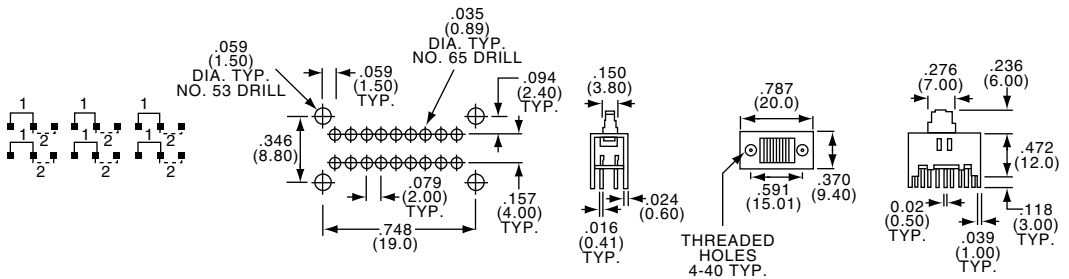

Tyco Electronics	Alcoswitch	Plating
8-1437576-8	MSS6200	Silver
8-1437576-9	MSS6200G	Gold

B
MSS Series

Slide Switches, Instrumentation Grade

SEE PAGE B20 FOR PRODUCT SPECIFICATIONS

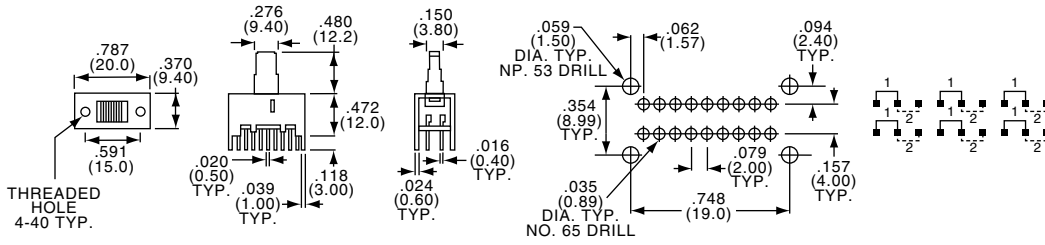

6PDT



MSS6250

Tyco Electronics	Alcoswitch	Plating
9-1437576-0	MSS6250	Silver

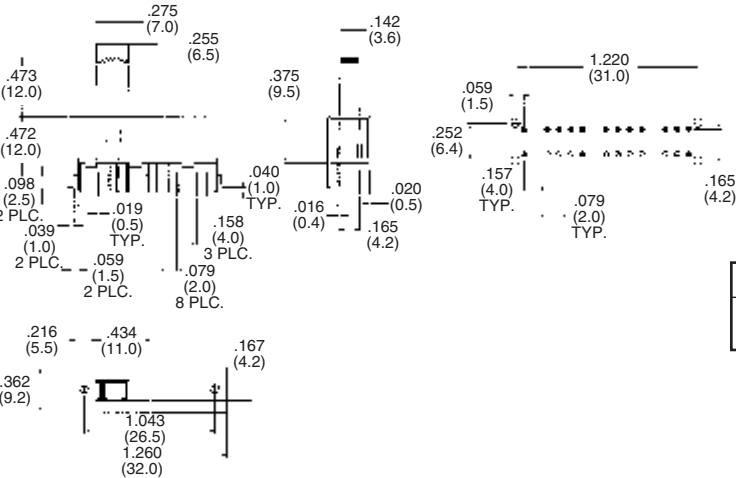

Tyco Electronics	Alcoswitch	Plating
9-1437576-3	MSS6350	Silver
—	MSS6350G	Gold

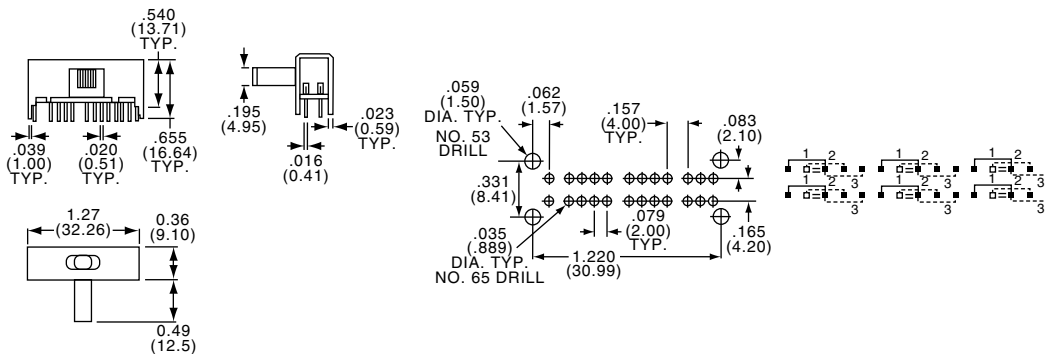

6P3T



MSS6350R

Tyco Electronics	Alcoswitch	Plating
9-1437576-4	MSS6350R	Silver
—	MSS6350RG	Gold

Slide Switches, Instrumentation Grade

MATERIAL SPECIFICATIONS:

ContactsSilver or gold over copper alloy
 Case MaterialCold rolled steel
 Actuator MaterialPolyester UL94V-0
 Terminals/Fixed Contacts.....Gold or silver plate over copper alloy
 Terminal SealEpoxy

ENVIRONMENTAL SPECIFICATIONS:

Operating Temperature.....-4°F to +185°F (-20°C to +85°C)
 Storage Temperature.....-40°F to +212°F (-40°C to +100°C)
 Solder Heat Resistance.....See page M3-4

TYPICAL PERFORMANCE CHARACTERISTICS:

Contact RatingGold: 0.4 VA 20 VDC or peak AC
 Silver: 300 mA @ 125 VAC
 Initial Contact Resistance.....30 Milliohms max.
 Contact Timing.....Make before break
 Insulation Resistance1,000 Megohms min.
 Dielectric Strength500 Volts RMS @ sea level
 Actuation Force600±300/470 Grams average
 Actuator Travel.....0.079" (2.01) approximate
 Life ExpectancyUp to 15,000 Cycles

B
MSSA Series

SP3T

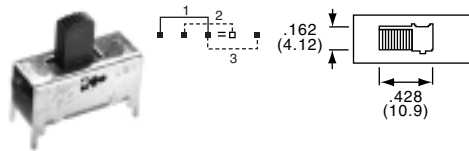

MSSA1350

Tyco Electronics	Alcoswitch	Plating	Mounting Style
3-1437580-3	MSSA1350	Silver	Upright
3-1437580-4	MSSA1350G	Gold	Upright

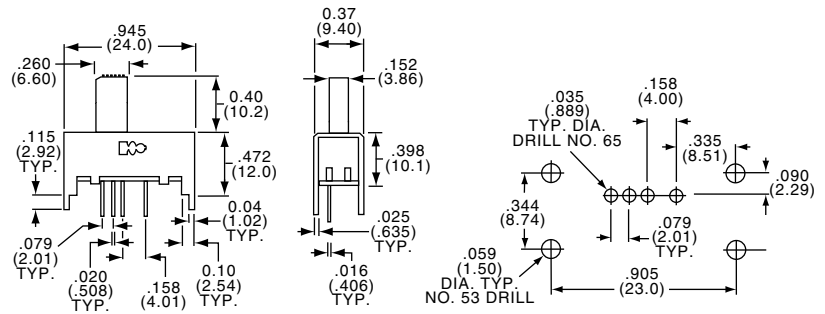

SP3T

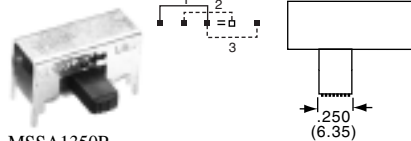

MSSA1350R

Tyco Electronics	Alcoswitch	Plating	Mounting Style
3-1437580-5	MSSA1350R	Silver	Rt. Angle
3-1437580-6	MSSA1350RG	Gold	Rt. Angle

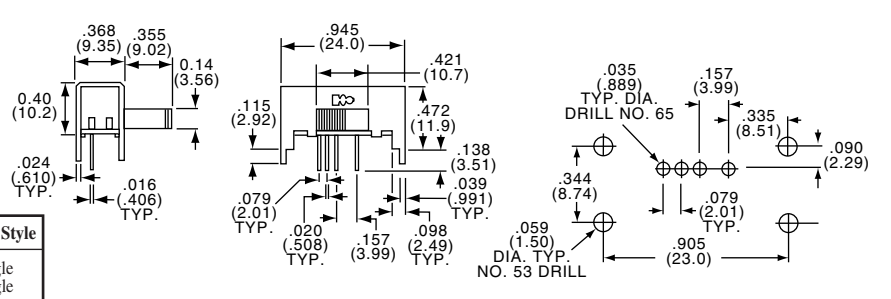

SP4T



MSSA1450

Tyco Electronics	Alcoswitch	Plating	Mounting Style
3-1437580-7	MSSA1450	Silver	Upright
3-1437580-8	MSSA1450G	Gold	Upright

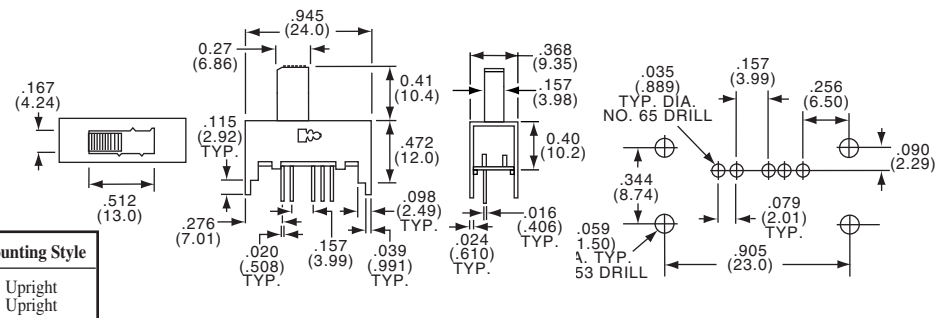

SP4T

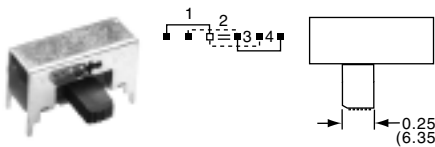

MSSA1450R

Tyco Electronics	Alcoswitch	Plating	Mounting Style
3-1437580-9	MSSA1450R	Silver	Rt. Angle
4-1437580-0	MSSA1450RG	Gold	Rt. Angle

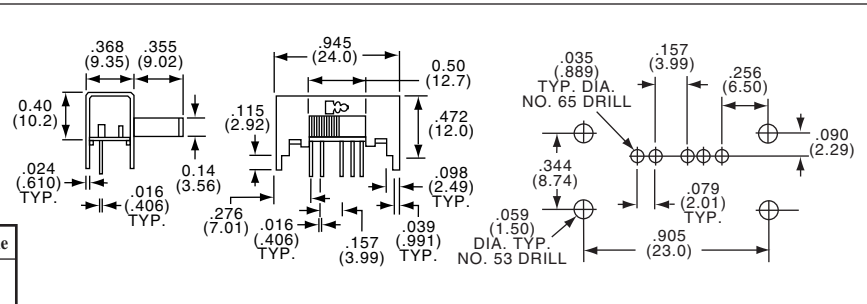

Slide Switches, Instrumentation Grade

SEE PAGE B26 FOR PRODUCT SPECIFICATIONS

DP3T

MSSA2350

Tyco Electronics	Alcoswitch	Plating	Mounting Style
5-1437580-3	MSSA2350	Silver	Upright
5-1437580-4	MSSA2350G	Gold	Upright

DP3T

MSSA2350R

Tyco Electronics	Alcoswitch	Plating	Mounting Style
5-1437580-5	MSSA2350R	Silver	Rt. Angle
5-1437580-6	MSSA2350RG	Gold	Rt. Angle

DP4T

MSSA2450

Tyco Electronics	Alcoswitch	Plating	Mounting Style
5-1437580-7	MSSA2450	Silver	Upright
5-1437580-8	MSSA2450G	Gold	Upright

DP4T

MSSA2450R

Tyco Electronics	Alcoswitch	Plating	Mounting Style
5-1437580-9	MSSA2450R	Silver	Rt. Angle
6-1437580-0	MSSA2450RG	Gold	Rt. Angle

Slide Switches, Instrumentation Grade

SEE PAGE B26 FOR PRODUCT SPECIFICATIONS

3P3T



MSSA3350

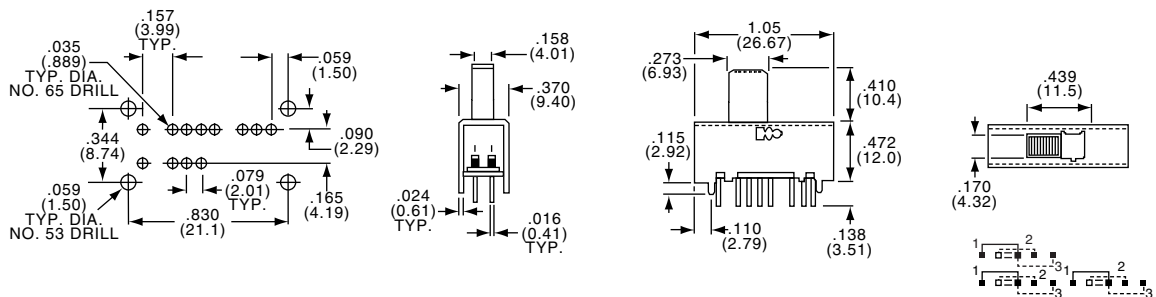

Tyco Electronics	Alcoswitch	Plating	Mounting Style
6-1437580-1	MSSA3350	Silver	Upright
6-1437580-2	MSSA3350G	Gold	Upright

3P3T



MSSA3350R

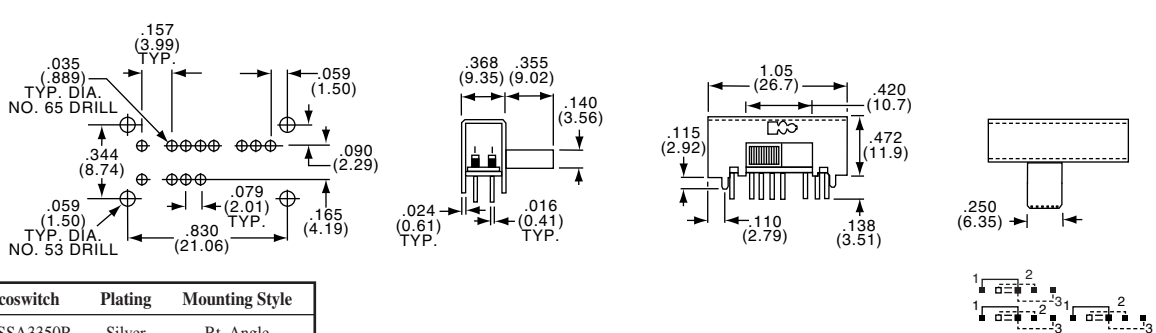

Tyco Electronics	Alcoswitch	Plating	Mounting Style
6-1437580-3	MSSA3350R	Silver	Rt. Angle
6-1437580-4	MSSA3350RG	Gold	Rt. Angle

3P4T



MSSA3450

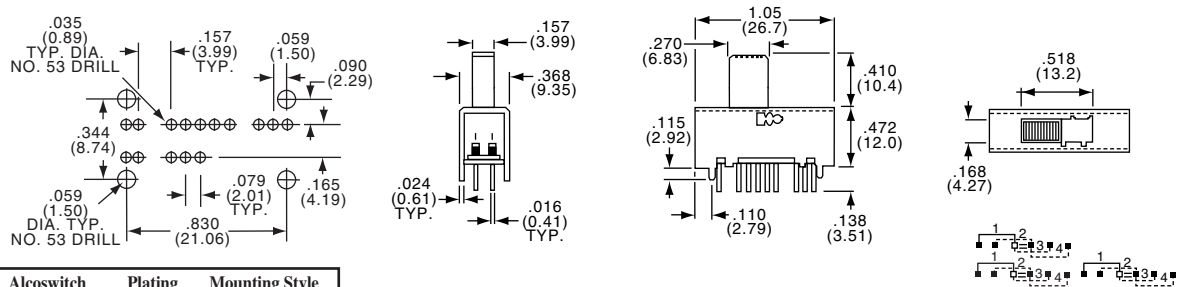

Tyco Electronics	Alcoswitch	Plating	Mounting Style
6-1437580-5	MSSA3450	Silver	Upright
6-1437580-6	MSSA3450G	Gold	Upright

3P4T



MSSA3450R

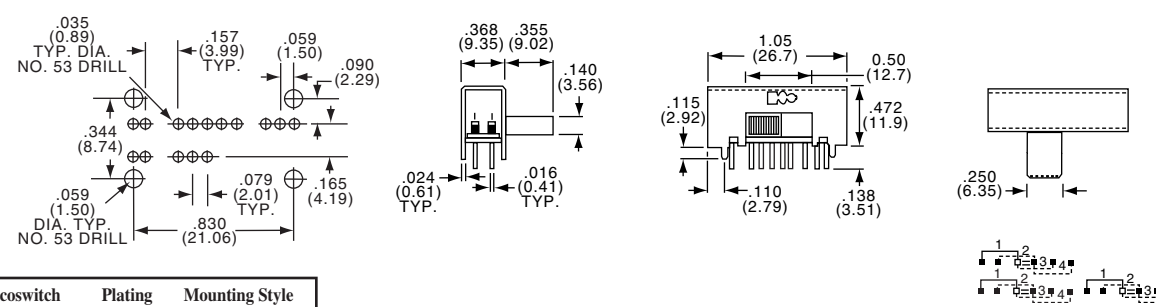

Tyco Electronics	Alcoswitch	Plating	Mounting Style
6-1437580-7	MSSA3450R	Silver	Rt. Angle
6-1437580-8	MSSA3450RG	Gold	Rt. Angle

Slide Switches, Instrumentation Grade

SEE PAGE B26 FOR PRODUCT SPECIFICATIONS

4P3T

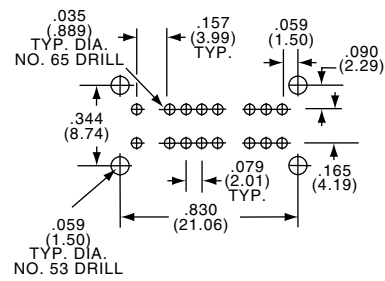
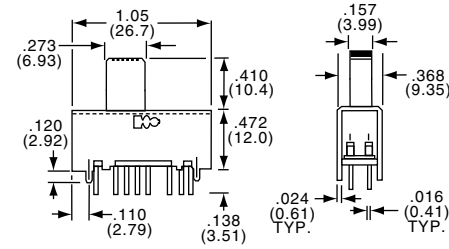
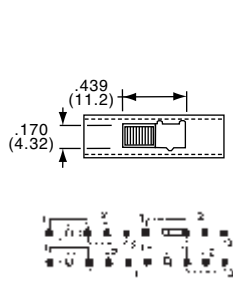

MSSA4350

Tyco Electronics	Alcoswitch	Plating	Mounting Style
6-1437580-9	MSSA4350	Silver	Upright
7-1437580-0	MSSA4350G	Gold	Upright

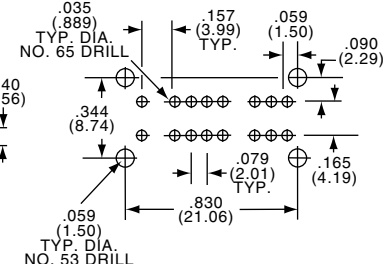
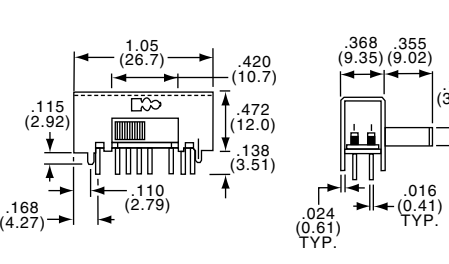
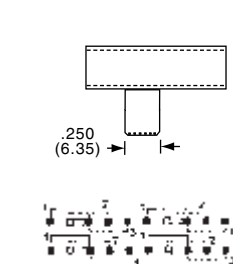

MSSA4350R

Tyco Electronics	Alcoswitch	Plating	Mounting Style
7-1437580-1	MSSA4350R	Silver	Rt. Angle
7-1437580-2	MSSA4350RG	Gold	Rt. Angle

4P3T

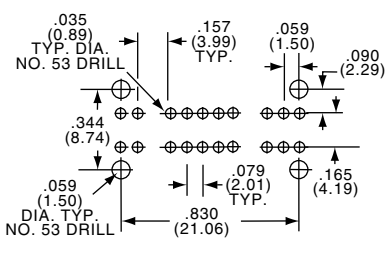
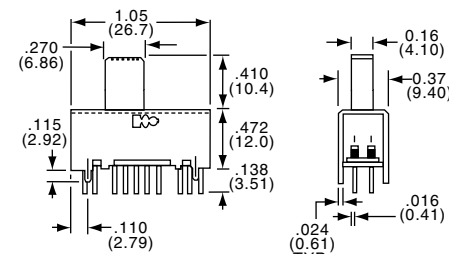
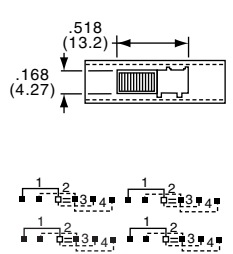

MSSA4450

Tyco Electronics	Alcoswitch	Plating	Mounting Style
7-1437580-3	MSSA4450	Silver	Upright
7-1437580-4	MSSA4450G	Gold	Upright

4P4T

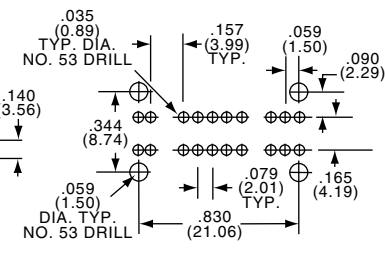
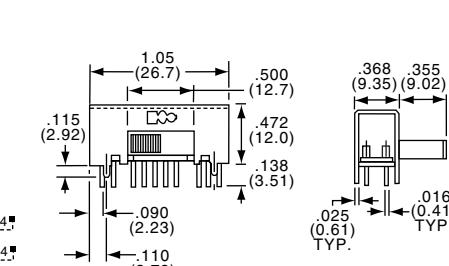
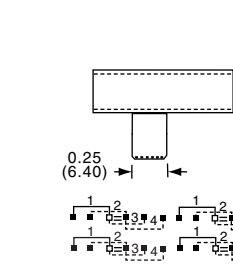

MSSA4450R

Tyco Electronics	Alcoswitch	Plating	Mounting Style
7-1437580-5	MSSA4450R	Silver	Rt. Angle
7-1437580-6	MSSA4450RG	Gold	Rt. Angle

4P4T

Slide Switches, Instrumentation Grade, .200 Terminal Spacing

MATERIAL SPECIFICATIONS:

ContactsSilver clad or gold plate
 Case MaterialPolyester
 Actuator MaterialPolyamide
 TerminalsGold or silver plate
 Terminal SealEpoxy

ENVIRONMENTAL SPECIFICATIONS:

Operating Temperature.....-4°F to +149°F (-20°C to +65°C)
 Storage Temperature.....-40°F to +212°F (-40°C to +100°C)
 Solder Heat Resistance.....See page M3-4

TYPICAL PERFORMANCE CHARACTERISTICS:

Contact RatingGold: 0.4 VA max. 20 VDC or peak AC
 Silver: 3 A @ 115 VAC, 1.5A @ 230 VAC
 Initial Contact Resistance20 Milliohms max.
 Contact TimingNon-shorting
 Insulation Resistance1,000 Megohms @ 500 VDC min.
 Dielectric Strength500 Volts RMS @ sea level
 Actuation Force600 ±300 Grams
 Actuator Travel......120" (3.05) Approximate
 Life ExpectancyUp to 30,000 Cycles

B
MSSA-01/04 Series

SPDT



MSSA114D

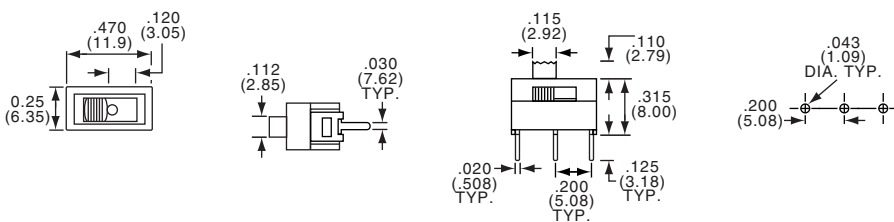

Tyco Electronics	Alcoswitch	Act. Code	Pg. M5	On	None	Off	Contacts
2-1437580-9	MSSA111DG	D	On	None	On	Gold	
3-1437580-0	MSSA111EG	E	On	Off	On	Gold	
3-1437580-1	MSSA114D	D	On	None	On	Silver	
3-1437580-2	MSSA114E	E	On	Off	On	Silver	

DPDT



MSSA214N

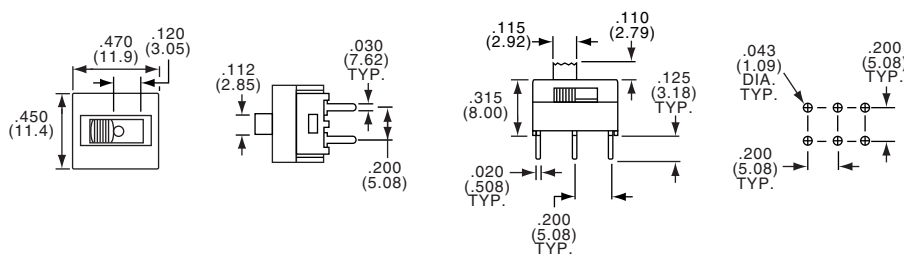

Tyco Electronics	Alcoswitch	Act. Code	Pg. M5	On	None	Off	Contacts
4-1437580-9	MSSA211NG	N	On	None	On	Gold	
5-1437580-2	MSSA214N	N	On	None	On	Silver	

Slide Switches, Instrumentation Grade, .100 Terminal Spacing

SEE PAGE B30 FOR PRODUCT SPECIFICATIONS

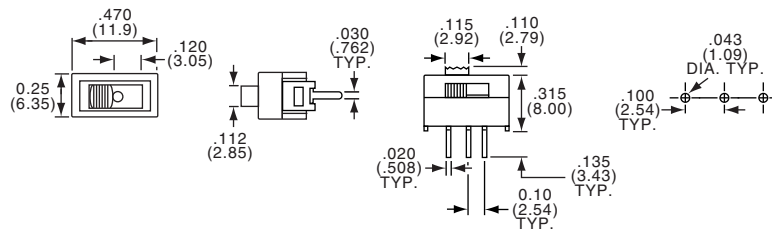

SPDT



MSSA104D

Tyco Electronics	Alcoswitch	Act. Code	Pg. M5				Contacts
1-1437580-7	MSSA101DG	D		On	None	On	Gold
—	MSSA101EG	E		On	Off	On	Gold
2-1437580-3	MSSA104D	D		On	None	On	Silver
2-1437580-6	MSSA104E	E		On	Off	On	Silver

B
MSSA-01/04 Series

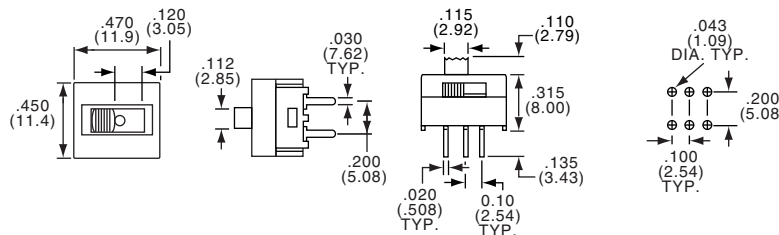

DPDT



MSSA204N

Tyco Electronics	Alcoswitch	Act. Code	Pg. M5				Contacts
4-1437580-4	MSSA204N	N		On	None	On	Silver

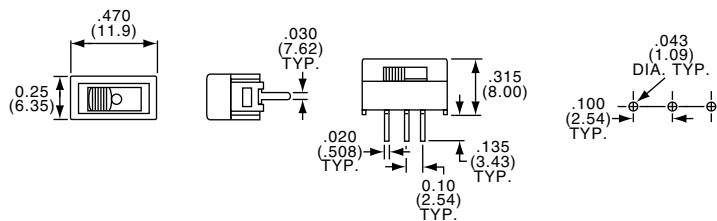

SPDT FLUSH ACTUATOR



MSSA104D1

Tyco Electronics	Alcoswitch	Act. Code	Pg. M5				Contacts
2-1437580-4	MSSA104D1	D		On	None	On	Silver

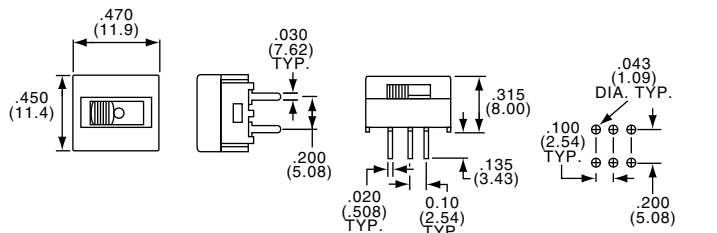

DPDT FLUSH ACTUATOR



MSSA204N1

Tyco Electronics	Alcoswitch	Act. Code	Pg. M5				Contacts
4-1437580-5	MSSA204N1	N		On	None	On	Silver
4-1437580-8	MSSA204P1	P		On	Off	On	Silver

Slide Switches, Instrumentation Grade, .100 Terminal Spacing

SEE PAGE B30 FOR PRODUCT SPECIFICATIONS

SPDT



MSSA101DGRA

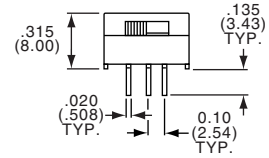
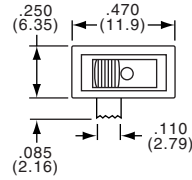
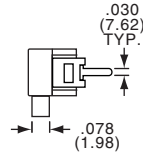
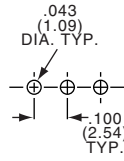

Tyco Electronics	Alcoswitch	Act. Code	Pg. M5	■ ■ ■			Contacts
1-1437580-9	MSSA101DGRA	D		On	None	On	Gold
2-1437580-1	MSSA101EGRA	E		On	Off	On	Gold
2-1437580-5	MSSA104DRA	D		On	None	On	Silver
2-1437580-8	MSSA104ERA	E		On	Off	On	Silver

DPDT



MSSA204NRA

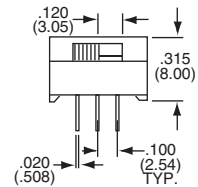
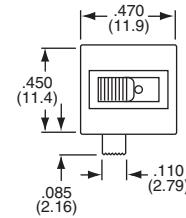
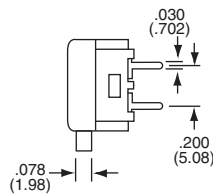
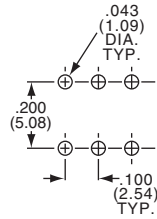

Tyco Electronics	Alcoswitch	Act. Code	Pg. M5	■ ■ ■			Contacts
4-1437580-2	MSSA201NGRA	N		On	None	On	Gold
8-1437580-2	MSSA201PGRA	P		On	Off	On	Gold
4-1437580-6	MSSA204NRA	N		On	None	On	Silver
—	MSSA204PRA	P		On	Off	On	Silver

Slide Switches, Low Profile, Instrumentation Grade

MATERIAL SPECIFICATIONS:

ContactsGold or silver over nickel over Cu alloy
 Frame MaterialNickel plated, Steel
 Actuator MaterialPOM 94 HB
 Terminals/Fixed Contacts.....Gold or silver over nickel over Cu alloy
 Terminal SealEpoxy

ENVIRONMENTAL SPECIFICATIONS:

Operating Temperature.....-4°F to +212°F (-20°C to +100°C)
 Storage Temperature.....-40°F to +212°F (-40°C to + 100°C)
 Solder Heat ResistanceSee page M3-4
 Recommended Cleaning.....No chlorine base or Freon can be used.
 Aqueous or 100% ethanol.

TYPICAL PERFORMANCE CHARACTERISTICS:

Contact RatingGold: 0.4 VA 20 VDC or peak AC
 Silver: 300 mA @ 125 VAC
 Initial Contact Resistance20 Milliohms max.
 Contact Timing.....Make-before-break
 Insulation Resistance1000 Megohms min.
 Dielectric Strength500 Volts RMS @ sea level
 Actuation Force50 to 450 Grams
 Actuator Travel.....0.079"-.158" (2.01-4.01)
 Life ExpectancyUp to 15,000 Cycles

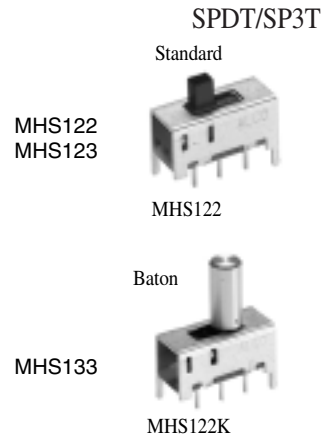
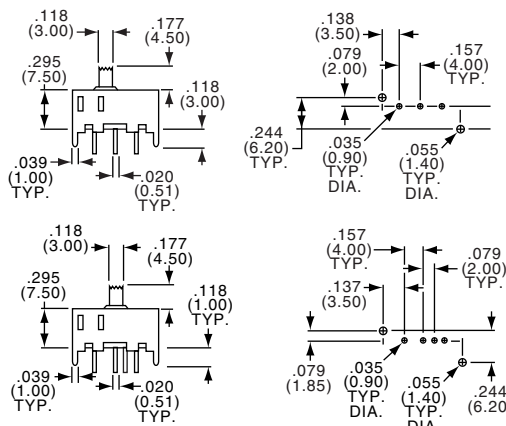
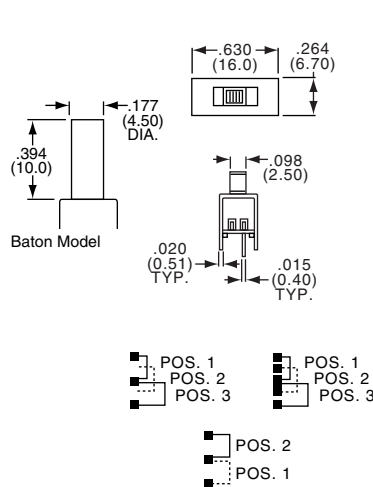

Standard Model Tyco Electronics	Alcoswitch	Baton Model Tyco Electronics	Alcoswitch	Type	On	None	Off	Contacts
1437576-9	MHS122	1-1437576-2	MHS122K	SPDT	On	None	On	Silver
1-1437576-5	MHS123	1-1437576-7	MHS123K	SPDT	On	Off	On	Silver
1-1437576-9	MHS133	2-1437576-2	MHS133K	SP3T	On	On	On	Silver
1-1437576-0	MHS122G	1-1437576-3	MHS122KG	SPDT	On	None	On	Gold
	MHS123G		MHS123KG	SPDT	On	Off	On	Gold
2-1437576-0	MHS133G	2-1437576-3	MHS133KG	SP3T	On	On	On	Gold

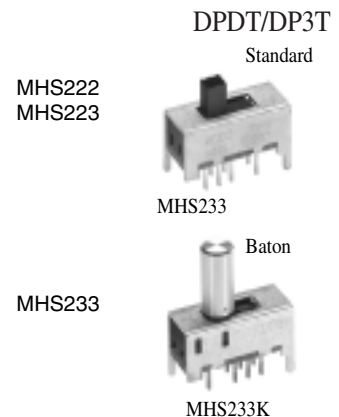
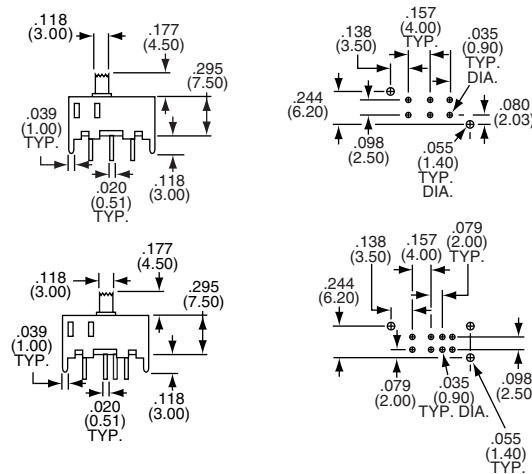
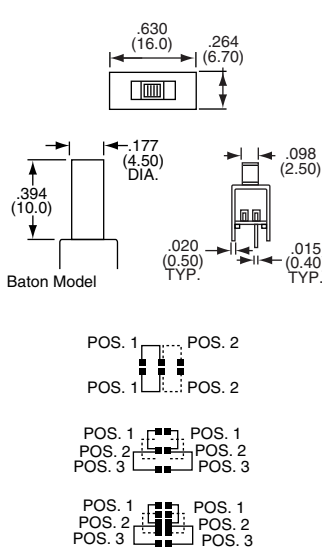

Standard Model Tyco Electronics	Alcoswitch	Baton Model Tyco Electronics	Alcoswitch	Type	On	None	Off	Contacts
2-1437576-5	MHS222	2-1437576-8	MHS222K	DPDT	On	None	On	Silver
3-1437576-1	MHS223	3-1437576-4	MHS223K	DPDT	On	Off	On	Silver
3-1437576-6	MHS233	3-1437576-9	MHS233K	DP3T	On	On	On	Silver
2-1437576-6	MHS222G	2-1437576-9	MHS222KG	DPDT	On	None	On	Gold
3-1437576-2	MHS223G	—	MHS223KG	DPDT	On	Off	On	Gold
3-1437576-7	MHS233G	4-1437576-0	MHS233KG	DP3T	On	On	On	Gold

Slide Switches, Low Profile, Right Angle, Instrumentation Grade

SEE PAGE B33 FOR PRODUCT SPECIFICATIONS

B
MHS Series

SPDT/SP3T



MHS122RA



MHS133GRA

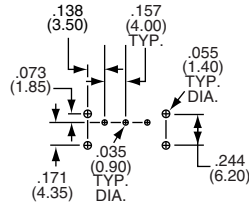
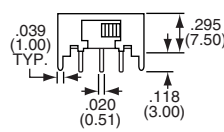
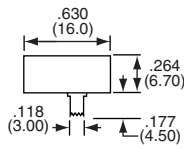

MHS122/123

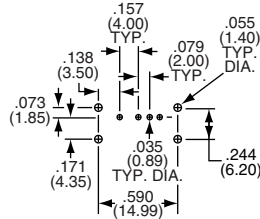
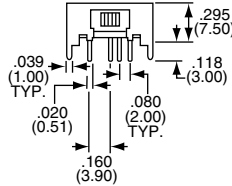
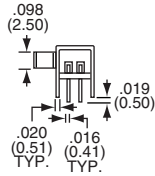

MHS133

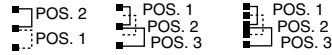

Tyco Electronics	Alcoswitch	Type				Contacts
1-1437576-4	MHS122RA	SPDT	On	None	On	Silver
1-1437576-8	MHS123RA	SPDT	On	Off	On	Silver
2-1437576-4	MHS133RA	SP3T	On	On	On	Silver
1-1437576-1	MHS122GRA	SPDT	On	None	On	Gold
1-1437576-6	MHS123GRA	SPDT	On	Off	On	Gold
2-1437576-1	MHS133GRA	SP3T	On	On	On	Gold

DPDT/DP3T



MHS222RA



MHS233GRA

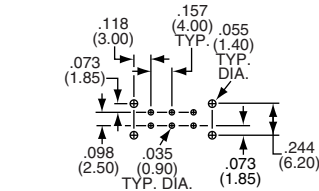
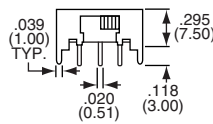
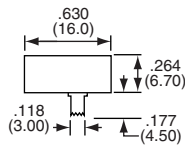

MHS222/223

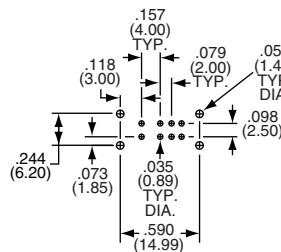
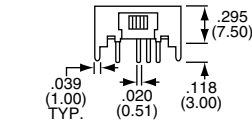
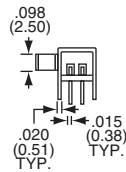

MHS233

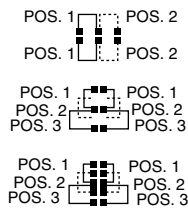

Tyco Electronics	Alcoswitch	Type				Contacts
3-1437576-0	MHS222RA	DPDT	On	None	On	Silver
3-1437576-5	MHS223RA	DPDT	On	Off	On	Silver
4-1437576-1	MHS233RA	DP3T	On	On	On	Silver
2-1437576-7	MHS222GRA	DPDT	On	None	On	Gold
3-1437576-3	MHS223GRA	DPDT	On	Off	On	Gold
3-1437576-8	MHS233GRA	DP3T	On	On	On	Gold

Slide Switches, Micro Size, Instrumentation Grade

MATERIAL SPECIFICATIONS:

ContactsSilver clad plate over copper alloy
 Cover Base MaterialPolyester
 Actuator MaterialPolyacetal
 TerminalsSilver over nickel plate over copper alloy
 Terminal SealMolded in

TYPICAL PERFORMANCE CHARACTERISTICS:

Contact Rating100 Milliamps @ 12 VDC
 Initial Contact Resistance20 Milliohms max.
 Contact TimingMake before break
 Insulation Resistance100 Megohms min.
 Dielectric Strength500 Volts RMS @ sea level
 Actuation Force250 Grams, (+200g, -150g)
 Actuator Travel0.079" (2.01)
 Life ExpectancyUp to 10,000 Cycles

ENVIRONMENTAL SPECIFICATIONS:

Operating Temperature+14°F to +140°F (-10°C to +60°C)
 Storage Temperature-4°F to +140°F (-20°C to +60°C)
 Solder Heat Resistance270°C+10°C, 5 seconds per MIL-STD-202, Method 210

B
SSJ Series

PCB Hole Layout

Circuit Diagram

SPDT

SSJ12

Part Number			
Tyco Electronics	Alcoswitch	Plating	Mounting Style
3-1437575-1	SSJ12	Silver	Upright

PCB Hole Layout

Circuit Diagram

SPDT

SSJ12R

Part Number			
Tyco Electronics	Alcoswitch	Plating	Mounting Style
3-1437575-2	SSJ12R	Silver	Right Angle

PCB Hole Layout

Circuit Diagram

SP3T

SSJ13

Part Number			
Tyco Electronics	Alcoswitch	Plating	Mounting Style
3-1437575-3	SSJ13	Silver	Upright

Slide Switches, Micro Size, Instrumentation Grade

MATERIAL SPECIFICATIONS:

ContactsSilver over nickel over copper alloy
 Case MaterialPolyacetal UL94HB
 Actuator MaterialPolyester UL94HB
 TerminalsSilver over nickel over copper alloy
 Terminal SealEpoxy
 Terminal Board.....UL 94 V-O

ENVIRONMENTAL SPECIFICATIONS:

Operating Temperature.....+14°F to +140°F (-10°C to +60°C)
 Storage Temperature.....+14°F to +140°F (-10°C to +60°C)
 Solder Heat Resistance.....230 ± 150 grams ± 5°C for 3 seconds per MIL-STD-202, Method 210

TYPICAL PERFORMANCE CHARACTERISTICS:

Contact Rating100 mA @ 30 VDC or peak AC
 Initial Contact Resistance30 Milliohms max.
 Contact TimingMake before break
 Insulation Resistance100 Megohms min.
 Dielectric Strength500 VAC
 Actuation Force200 ± 150 Grams
 Life ExpectancyUp to 10,000 Cycles

B
MMS Series

SPDT



MMS12

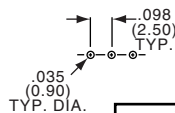
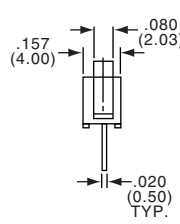
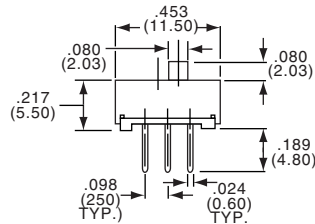

Circuit Diagram



Part Number				
Tyco Electronics	Alcoswitch	Type	Plating	Mounting Style
1437575-4	MMS12	SPDT	Silver	Upright

DPDT



MMS22

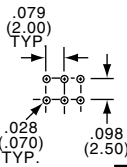
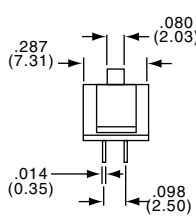
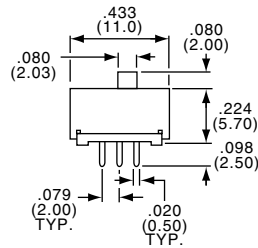

Circuit Diagram

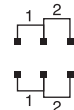

Part Number				
Tyco Electronics	Alcoswitch	Type	Plating	Mounting Style
1437575-5	MMS22	DPDT	Silver	Upright

DPDT



MMS22R

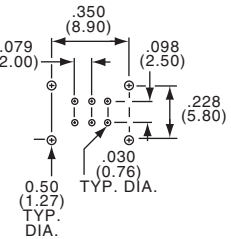
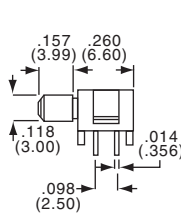
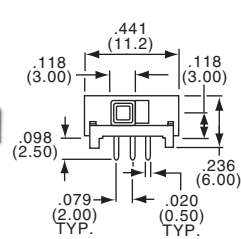

Circuit Diagram

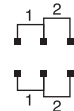

Part Number				
Tyco Electronics	Alcoswitch	Type	Plating	Mounting Style
1437575-6	MMS22R	DPDT	Silver	Right Angle

DP3T



MMS23

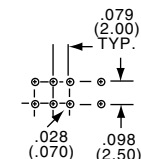
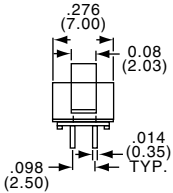
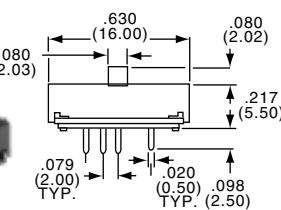

Circuit Diagram

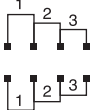

Part Number				
Tyco Electronics	Alcoswitch	Type	Plating	Mounting Style
1437575-8	MMS23	DP3T	Silver	Upright

DP3T



MMS23R

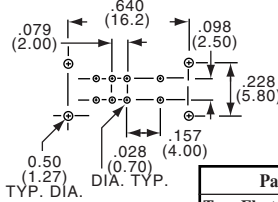
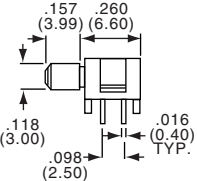
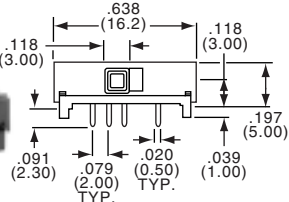

Circuit Diagram

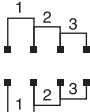

Part Number				
Tyco Electronics	Alcoswitch	Type	Plating	Mounting Style
1437575-9	MMS23R	DP3T	Silver	Right Angle

Slide Switches, Micro Size, Instrumentation Grade

SEE PAGE B36 FOR PRODUCT SPECIFICATIONS

Circuit Diagram

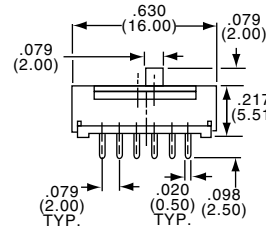
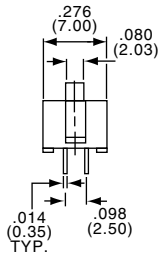
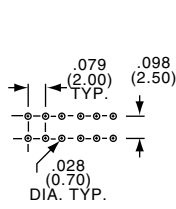
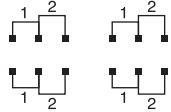

4PDT

MMS42

Part Number				
Tyco Electronics	Alcoswitch	Type	Plating	Mounting Style
I-1437575-0	MMS42	4PDT	Silver	Upright

Circuit Diagram

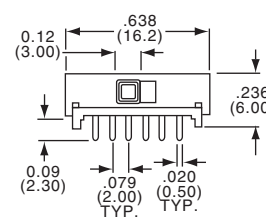
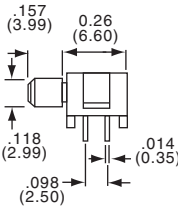
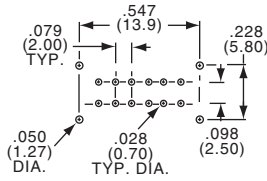
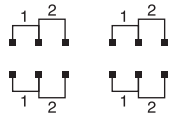

4PDT

MMS42R

Part Number				
Tyco Electronics	Alcoswitch	Type	Plating	Mounting Style
I-1437575-1	MMS42R	4PDT	Silver	Right Angle

Circuit Diagram

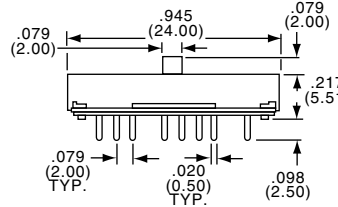
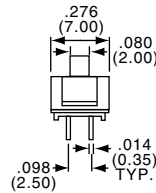
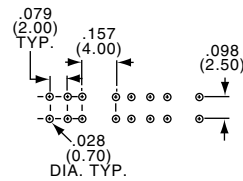
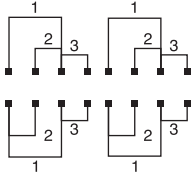

4P3T

MMS43

Part Number				
Tyco Electronics	Alcoswitch	Type	Plating	Mounting Style
I-1437575-2	MMS43	4P3T	Silver	Upright

Circuit Diagram

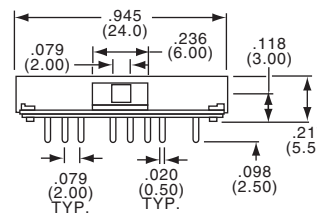
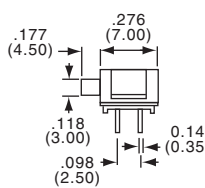
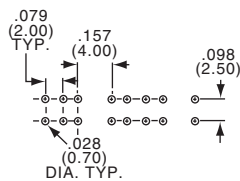
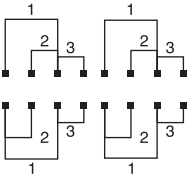

4P3T

MMS43R

Part Number				
Tyco Electronics	Alcoswitch	Type	Plating	Mounting Style
I-1437575-3	MMS43R	4P3T	Silver	Right Angle

Slide Switches, Micro Size, Instrumentation Grade

MATERIAL SPECIFICATIONS:

ContactsGold or silver plate over nickel plate
 Case MaterialSteel, tin plate
 Actuator MaterialPolyacetal UL94HB
 TerminalsGold or silver plate over nickel plate
 Terminal SealEpoxy

ENVIRONMENTAL SPECIFICATIONS:

Operating Temperature.....-4°F to +176°F (-20°C to +80°C)
 Storage Temperature.....-40°F to +212°F (-40°C to +100°C)
 Solder Heat Resistance.....+260°C (+500°F) for 5 seconds
 per MIL-STD-202, Method 210

TYPICAL PERFORMANCE CHARACTERISTICS:

Contact RatingGold: 0.4 VA @ 20 VDC or peak AC
 Silver: 100 mA @ 30 VDC
 Initial Contact Resistance.....30 Milliohms max.
 Contact Timing.....Make before break
 Insulation Resistance100 Megohms min.
 Dielectric Strength500 VAC
 Actuation Force250 ± 150 Grams
 Life ExpectancyUp to 10,000 Cycles
 Travel0.079" (2.01)

B
SSB Series

SPDT



SSB12

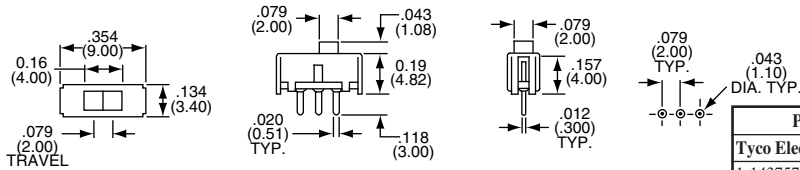

Circuit Diagram



Part Number				
Tyco Electronics	Alcoswitch	Type	Plating	Mounting Style
1-1437575-8	SSB12	SPDT	Silver	Upright
1-1437575-9	SSB12G	SPDT	Gold	Upright

SPDT



SSB12R

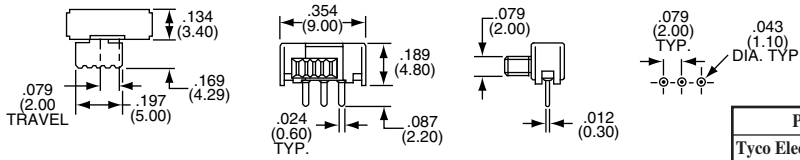

Circuit Diagram



Part Number				
Tyco Electronics	Alcoswitch	Type	Plating	Mounting Style
2-1437575-0	SSB12R	SPDT	Silver	Right Angle
2-1437575-1	SSB12RG	SPDT	Gold	Right Angle

DPDT



SSB22

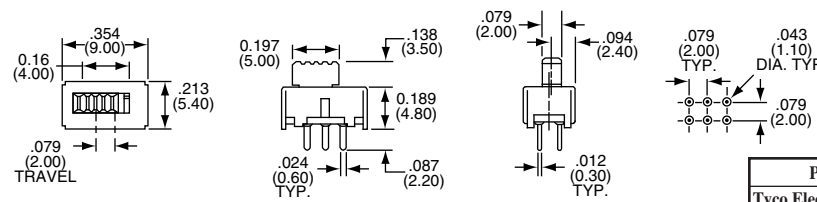

Circuit Diagram

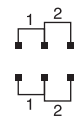

Part Number				
Tyco Electronics	Alcoswitch	Type	Plating	Mounting Style
2-1437575-2	SSB22	DPDT	Silver	Upright
2-1437575-3	SSB22G	DPDT	Gold	Upright

DPDT



SSB22R

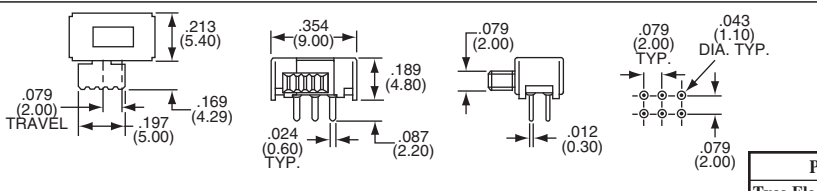

Circuit Diagram

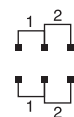

Part Number				
Tyco Electronics	Alcoswitch	Type	Plating	Mounting Style
2-1437575-4	SSB22R	DPDT	Silver	Right Angle
2-1437575-5	SSB22RG	DPDT	Gold	Right Angle

4PDT



SSB42

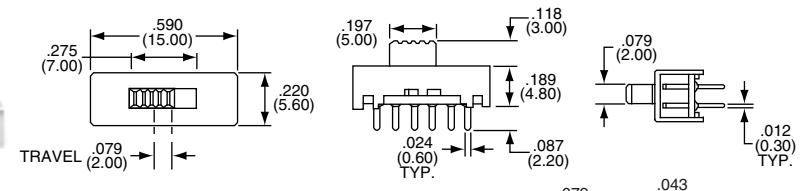

Circuit Diagram

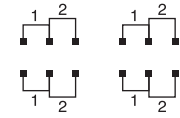

Part Number				
Tyco Electronics	Alcoswitch	Type	Plating	Mounting Style
2-1437575-8	SSB42	4PDT	Silver	Upright
2-1437575-9	SSB42G	4PDT	Gold	Upright

Slide Switches, Micro Size, Instrumentation Grade

MATERIAL SPECIFICATIONS:

ContactsSilver or gold plate
 Case MaterialPolyester PPS UL94VO
 Actuator MaterialPolyamide UL94HB
 Cover MaterialPolyamide UL94HB
 TerminalsSilver or gold plate
 Terminal SealEpoxy

ENVIRONMENTAL SPECIFICATIONS:

Operating Temperature.....-4°F to +158°F (-20°C to +70°C)
 Storage Temperature.....-40°F to +194°F (-40°C +90°C)
 Solder Heat Resistance260°C (+500°F) for 5 seconds
 per MIL-STD-202, Method 210

TYPICAL PERFORMANCE CHARACTERISTICS:

Contact RatingGold: 0.4 VA max. @ 20 VDC or peak AC
 Silver: 100 Milliamps @ 30 VDC
 Initial Contact Resistance30 Milliohms max.
 Contact TimingBreak-Before-Make
 Insulation Resistance100 Megohms min.
 Dielectric Strength500 VAC
 Actuation Force250 ± 100 Grams
 Actuator Travel.....0.098" (2.49)
 Life ExpectancyUp to 10,000 Cycles

B
SSA Series

SPDT

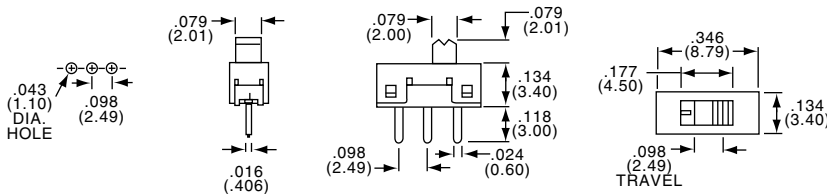

SSA12

Circuit Diagram



Part Number			
Tyco Electronics	Alcoswitch	Plating	Mounting Style
1-1437575-4	SSA12	Silver	Upright
1-1437575-5	SSA12G	Gold	Upright

DPDT

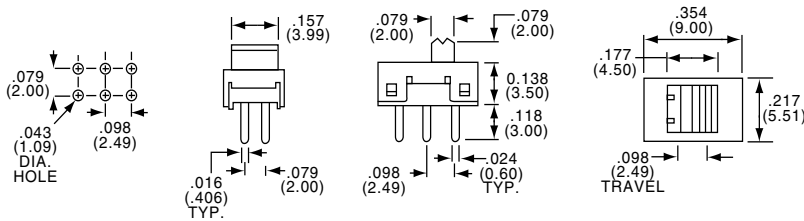

SSA22

Circuit Diagram



Part Number			
Tyco Electronics	Alcoswitch	Plating	Mounting Style
1-1437575-6	SSA22	Silver	Upright
1-1437575-7	SSA22G	Gold	Upright

Slide Switches, PC Tails, Wiping Contact, Consumer Grade

MATERIAL SPECIFICATIONS:

ContactsSilver plate over copper alloy
 Case MaterialSteel
 Actuator MaterialPolycarbonate
 Terminals/Fixed Contacts.....Silver plate over copper alloy
 Terminal SealEpoxy

TYPICAL PERFORMANCE CHARACTERISTICS:

Contact Rating250 mA @ 125 VAC, 150 mA @ 12 VDC
 Initial Contact Resistance30 Milliohms max.
 Contact TimingBreak before make
 Insulation Resistance500 Megohms min.
 Dielectric Strength500 VAC
 Actuation Force100-300 Grams
 Actuator Travel.....0.126" (3.20)
 Life ExpectancyUp to 10,000 Cycles

ENVIRONMENTAL SPECIFICATIONS:

Operating Temperature.....14°F to +140°F (-10°C to +60°C)
 Storage Temperature.....14°F to +140°F (-10°C to +60°C)

2 TO 6 POSITIONS

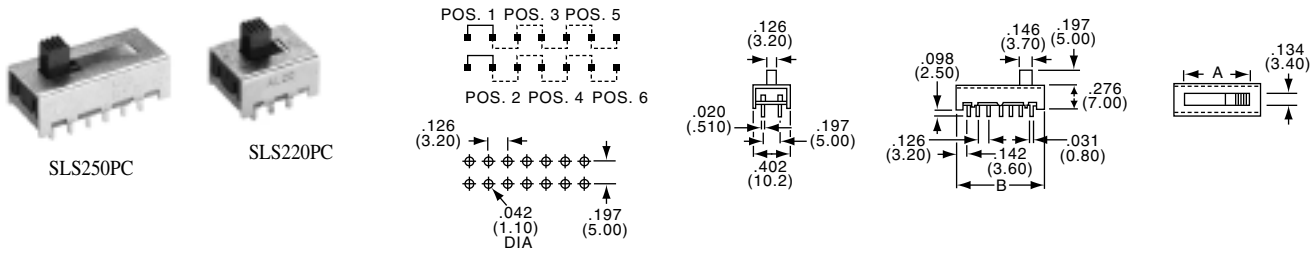

Part Number		Type	Dim.A	Dim.B
Tyco Electronics	Alcoswitch			
3-1437577-9	SLS220PC	2 Positions	.272(6.91)	.535(13.59)
4-1437577-1	SLS230PC	3 Positions	.398(10.11)	.661(16.79)
4-1437577-3	SLS240PCA	4 Positions	.524(13.31)	.787(19.99)
4-1437577-5	SLS250PC	5 Positions	.650(16.51)	.913(23.19)
4-1437577-7	SLS260PC	6 Positions	.776(19.71)	1.039(26.39)

SL Series

Slide Switches, PC Tails, Lever or Knob Actuator

2 TO 10 POSITIONS

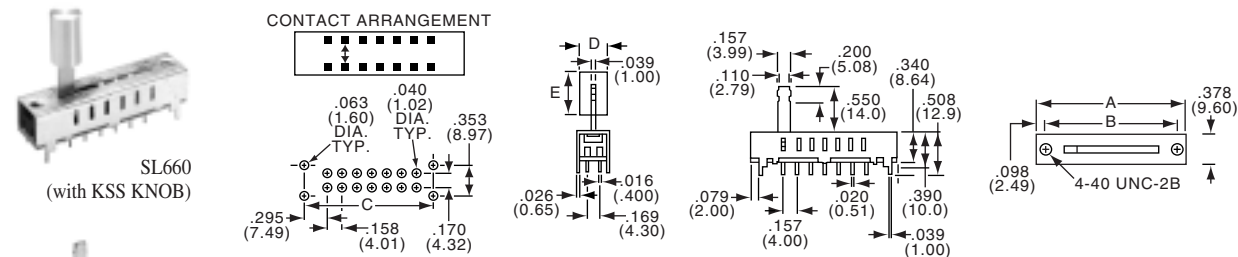

Part Number		Type	Dim. A	Dim. B	Dim. C	Knob Only	Description	Dim. D	Dim. E
Tyco Electronics	Alcoswitch								
1437577-9	SL220	2 Positions	.95(24.13)	.750(19.05)	.750(19.05)	KSS10A	Aluminum-Clear Anodize	.270(6.86)	.500(12.70)
1-1437577-0	SL330	3 Positions	1.11(28.19)	.910(23.1)	.910(23.1)	KSS10B	Aluminum-Black Anodize	.270(6.86)	.500(12.70)
1-1437577-1	SL550	5 Positions	1.42(36.07)	1.22(30.99)	1.22(31.1)	KSS20A	Aluminum-Clear Anodize	.305(7.75)	.512(13.00)
1-1437577-2	SL660	6 Positions	1.58(40.13)	1.38(35.05)	1.38(35.1)	KSS20B	Aluminum-Black Anodize	.305(7.75)	.512(13.00)
1-1437577-3	SL770	7 Positions	1.74(44.20)	1.54(39.12)	1.54(39.1)				
1-1437577-4	SL880	8 Positions	1.89(48.01)	1.70(43.18)	1.70(43.1)				
1437577-8	SL1000	10 Positions	2.21(56.13)	2.01(51.05)	2.01(51.5)				

Slide Switches, Panel Mount, Wiping Contact, Consumer Grade

MATERIAL SPECIFICATIONS:

ContactsSilver over nickel plate copper alloy
 Case MaterialSteel-zinc plated
 Actuator MaterialPBT 30% glass
 Terminals/Fixed Contacts.....Silver over nickel plate copper alloy
 Terminal SealEpoxy

ENVIRONMENTAL SPECIFICATIONS:

Operating Temperature.....-4°F to +185°F (-20°C to +85°C)
 Storage Temperature.....-40°F to +212°F (-40°C to +100°C)
 Solder Heat Resistance+300°C (+572°F) for 5 seconds

TYPICAL PERFORMANCE CHARACTERISTICS:

Contact Rating500 mA @ 125 VAC, 200 mA @ 12 VDC
 Initial Contact Resistance30 Milliohms max.
 Contact TimingBreak-Before-Make
 Insulation Resistance500 Megohms min.
 Dielectric Strength500 VAC
 Actuation ForceSLS: 100-300 Grams; SLSA: 220, 300 -500 Grams
 Plunger/Actuator Travel:0.106" (2.69)
 Life ExpectancyUp to 10,000 Cycles

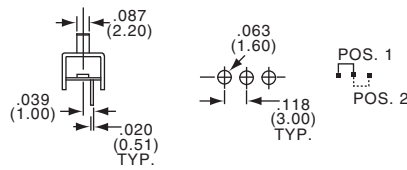
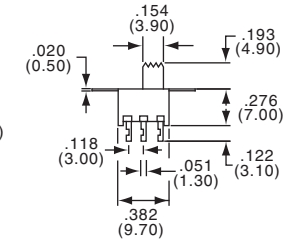
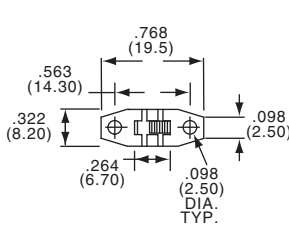

SPDT



SLS120

Part Number		Type	Mounting	Terminals	Contacts
Tyco Electronics	Alcoswitch	SLS120	Panel	Lug	
1-1437577-5					

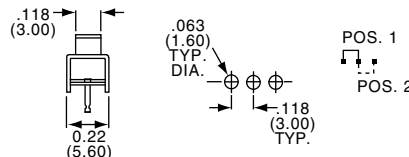
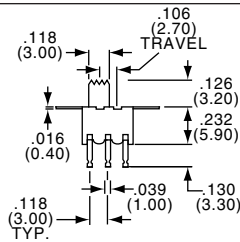
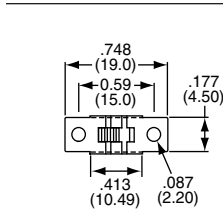

SPDT



SLSA120

Part Number		Type	Mounting	Terminals	Contacts
Tyco Electronics	Alcoswitch	SLSA120	Panel	Turret	
5-1437577-3					

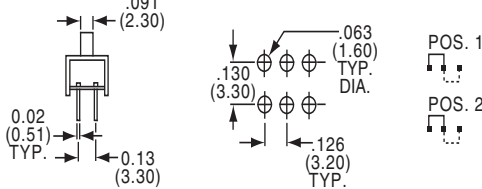
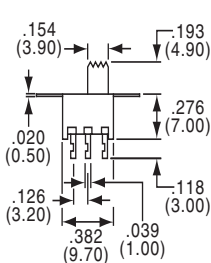
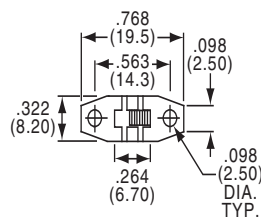

DPDT



SLS220

Part Number		Type	Mounting	Terminals	Contacts
Tyco Electronics	Alcoswitch	SLS220	Panel	Lug	
3-1437577-7					

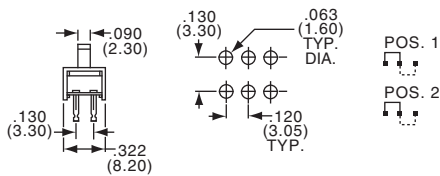
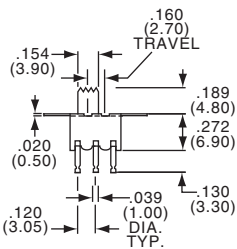
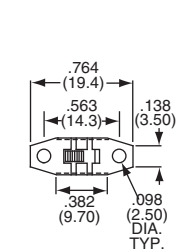

DPDT



SLSA220

Part Number		Type	Mounting	Terminals	Contacts
Tyco Electronics	Alcoswitch	SLSA220	Panel	Turret	
5-1437577-5					

Slide Switches, Wiping Contacts, Consumer Grade

MATERIAL SPECIFICATIONS:

ContactsCopper alloy-silver/nickel
 Case MaterialSteel-zinc plate
 Actuator MaterialPBT 30% Glass
 Terminals/Fixed Contacts.....Copper, alloy, silver/nickel plate
 Terminal SealEpoxy

ENVIRONMENTAL SPECIFICATIONS:

Operating Temperature.....-4°F to + 185°F (-20°C to + 85°C)
 Storage Temperature.....-40°F to + 212°F (-40°C to + 100°C)
 Solder Heat Resistance+300°C (+572°F) for 5 seconds

TYPICAL PERFORMANCE CHARACTERISTICS:

Contact Rating500 mA @ 125 VAC, 200 mA @ 12 VDC
 Initial Contact Resistance30 Milliohms max.
 Contact TimingBreak before make
 Insulation Resistance500 Megohms min.
 Dielectric Strength500 VAC
 Actuation Force350±150 Grams
 Plunger/Actuator Travel:0.106 (2.69)
 Life ExpectancyUp to 10,000 Cycles

B
SLS/SLSA Series

SPDT



Lug

SLS1201

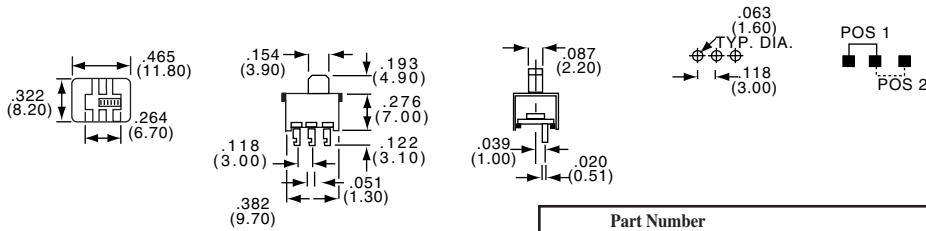

Part Number				
Tyco Electronics	Alcoswitch	Type	Mounting	Terminals Contacts
1-1437577-6	SLS1201	SPDT	PC	Lug

DPDT



Lug

SLS2201

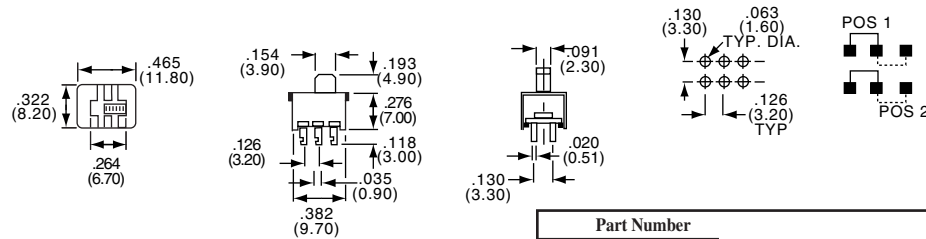

Part Number				
Tyco Electronics	Alcoswitch	Type	Mounting	Terminals Contacts
3-1437577-8	SLS2201	DPDT	PC	Lug

SPDT

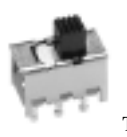

Turret

SLSA1201

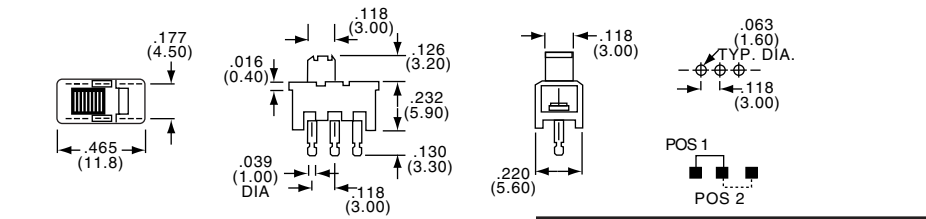

Part Number				
Tyco Electronics	Alcoswitch	Type	Mounting	Terminals Contacts
5-1437577-4	SLSA1201	SPDT	PC	Turret

DPDT



Turret

SLSA2201

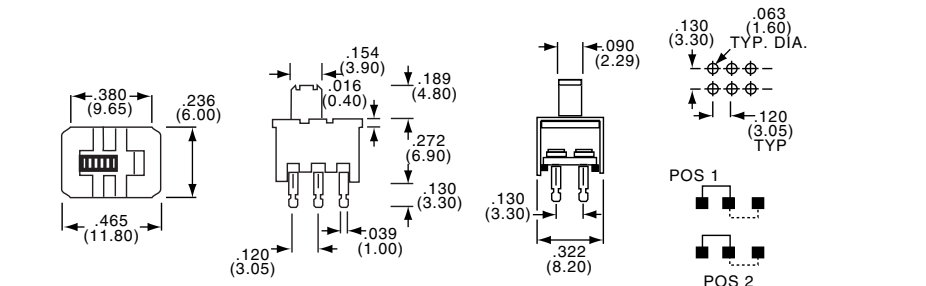

Part Number				
Tyco Electronics	Alcoswitch	Type	Mounting	Terminals Contacts
5-1437577-6	SLSA2201	DPDT	PC	Turret

Slide Switches, Miniature, Rolling Contact, Economy Grade

MATERIAL SPECIFICATIONS:

ContactsSilver over nickel plate over copper alloy
 Case MaterialTin plate over steel
 Actuator MaterialPolycarbonate
 Terminals/Fixed Contacts.....Silver over nickel plate over copper alloy

TYPICAL PERFORMANCE CHARACTERISTICS:

Contact Rating250 mA @ 125 VAC, 150 mA @ 12 VDC
 Initial Contact Resistance30 Milliohms max.
 Contact TimingBreak before make
 Insulation Resistance500 Megohms min.
 Dielectric Strength500 VAC
 Actuation Force340 ± 57 Grams
 Actuator Travel.....0.126" (3.20)
 Life ExpectancyUp to 6,000 to 10,000 Cycles

ENVIRONMENTAL SPECIFICATIONS:

Operating Temperature.....14°F to +185°F (-10°C to +85°C)
 Storage Temperature.....14°F to +185°F (-10°C to +85°C)

B
SLS Series

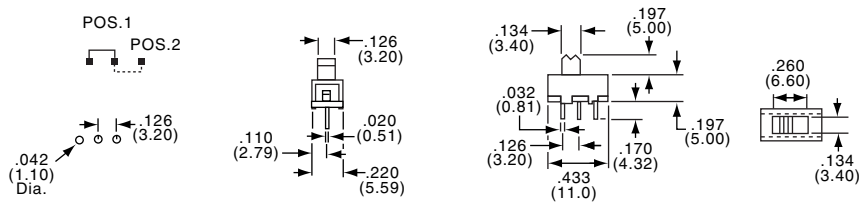

SPDT



SLS121PC

Part Number		
Tyco Electronics	Alcoswitch	Mounting Style
1-1437577-9	SLS121PC	Printed Circuit

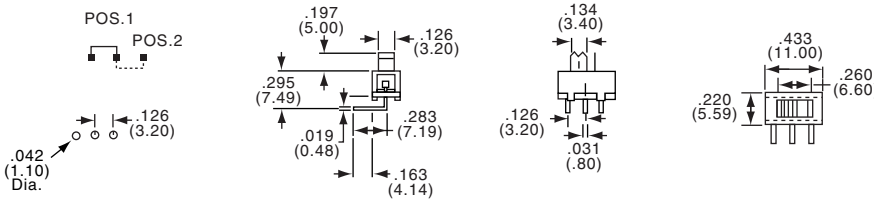

SPDT



SLS121RA

Part Number		
Tyco Electronics	Alcoswitch	Mounting Style
2-1437577-2	SLS121RA	Right Angle PC

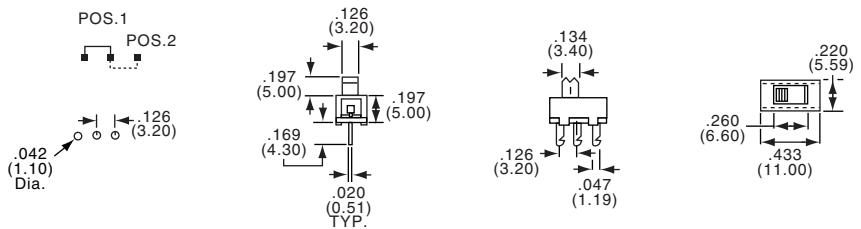

SPDT



SLS1211

Part Number		
Tyco Electronics	Alcoswitch	Mounting Style
1-1437577-8	SLS1211	Printed Circuit

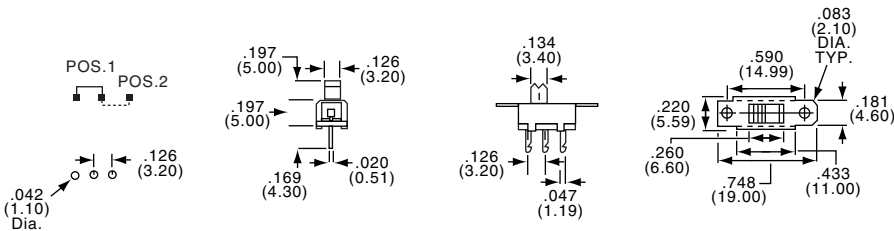

SPDT



SLS121

Part Number		
Tyco Electronics	Alcoswitch	Mounting Style
1-1437577-7	SLS121	Panel Mounted

Slide Switches, Miniature, Rolling Contact, Economy Grade

MATERIAL SPECIFICATIONS:

ContactsSilver over nickel flash over copper alloy
 Case MaterialSteel
 Actuator MaterialPolycarbonate
 Terminals/Fixed Contacts.....Silver over nickel over copper alloy

ENVIRONMENTAL SPECIFICATIONS:

Operating Temperature.....+14°F to +185°F (-10°C to +85°C)
 Storage Temperature.....+14°F to +185°F (-10°C to +85°C)
 Solder Heat Resistance.....+260°C for 5 seconds

TYPICAL PERFORMANCE CHARACTERISTICS:

Contact Rating250mA @ 125 VAC
 150mA @ 12VDC
 Initial Contact Resistance20 Milliohms max.
 Contact TimingBreak-Before-Make
 Insulation Resistance>50 Megohms.
 Dielectric Strength500 Volts RMS @ sea level
 Actuation Force340 ± 57 Grams
 Plunger/Actuator Travel:0.260" to 0.512" (6.60-13.00)
 Life ExpectancyUp to 10,000 Cycles at no load

B
SLS Series

SP3T

SLS131PC

Part Number		
Tyco Electronics	Alcoswitch	Mounting Style
2-1437577-4	SLS131PC	Printed Circuit

SP3T

SLS131RA

Part Number		
Tyco Electronics	Alcoswitch	Mounting Style
2-1437577-6	SLS131RA	Right Angle PC

SP4T

SLS141PC

Part Number		
Tyco Electronics	Alcoswitch	Mounting Style
2-1437577-8	SLS141PC	Printed Circuit

SP4T

SLS141RA

Part Number		
Tyco Electronics	Alcoswitch	Mounting Style
3-1437577-0	SLS141RA	Right Angle PC

SP5T

SLS151PC

Part Number		
Tyco Electronics	Alcoswitch	Mounting Style
3-1437577-2	SLS151PC	Printed Circuit

SP5T

SLS151RA

Part Number		
Tyco Electronics	Alcoswitch	Mounting Style
3-1437577-4	SLS151RA	Right Angle PC

Slide Switches, Baton-Toggle, Multi Pole

MATERIAL SPECIFICATIONS:

ContactsSilver clad over nickel plated copper alloy
 Case MaterialSteel, tin plate
 Actuator MaterialABS plastic/Aluminum cap
 Terminals/Fixed Contacts.....Silver over nickel plated copper alloy
 Terminal SealEpoxy

ENVIRONMENTAL SPECIFICATIONS:

Operating Temperature.....+5°F to +131°F (-15°C to +55°C)
 Storage Temperature.....-4°F to +140° F (-20°C to +60°C)
 Solder Heat Resistance.....Hand: 300°C for 3 seconds
 Wave: 250°C for 5 seconds

TYPICAL PERFORMANCE CHARACTERISTICS:

Contact Rating300 mA @ 125 VAC, 200 mA @ 12VDC
 Initial Contact Resistance20 Milliohms max.
 Contact TimingSee table below
 Insulation Resistance500 Megohms min.
 Dielectric Strength500 Volts RMS @ sea level
 Actuation Force450 ± 250 Grams
 Plunger/Actuator Travel30°
 Life ExpectancyUp to 10,000 Cycles

B
CST Series

DPDT

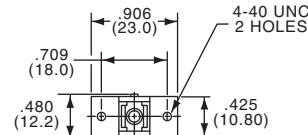
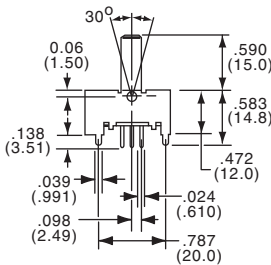
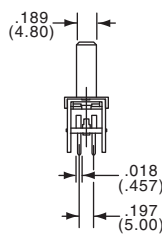
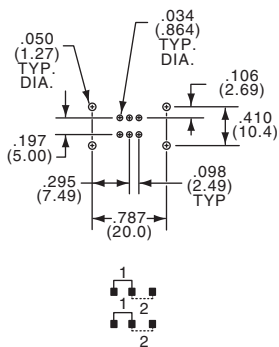

CST022NK

Part Number					Contact Timing
Tyco Electronics	Alcoswitch				
1437576-2	CST022NK	None	On	On	Non Shorting - Break-Before-Make (On) indicates momentary position.

DP3T

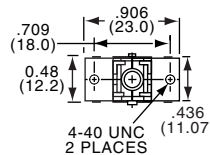
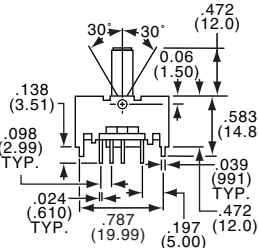
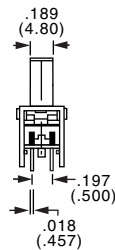
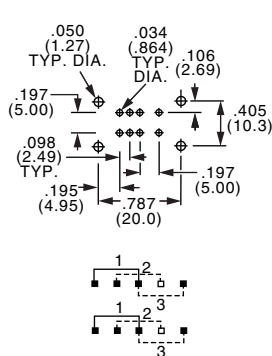

CST023NK

Part Number					Contact Timing
Tyco Electronics	Alcoswitch				
1437576-4	CST023NK	On	On	On	Non Shorting

Slide Switches, Baton-Toggle, Multi Pole

SEE PAGE B45 FOR PRODUCT SPECIFICATIONS

B
CST Series

4PDT

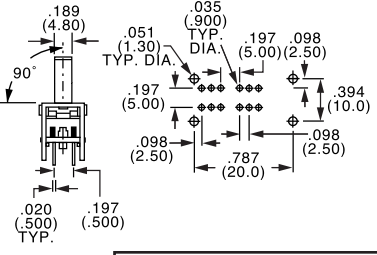
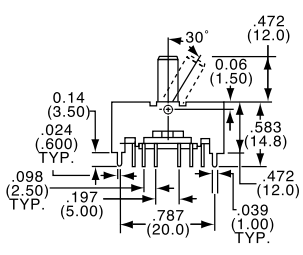
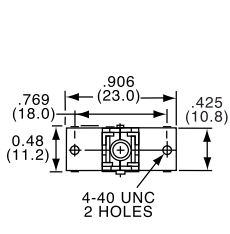

Circuit Diagram

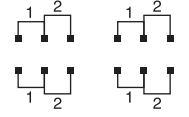

CST042NK

Part Number					
Tyco Electronics	Alcoswitch				Contact Timing
1437576-5	CST042NK	None	On	On	Non Shorting

4P3T

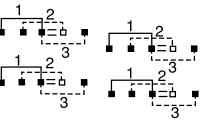
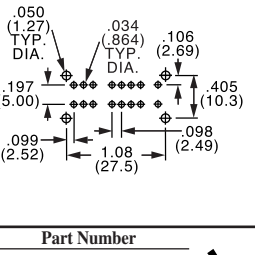
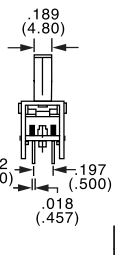
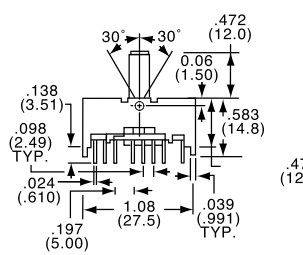
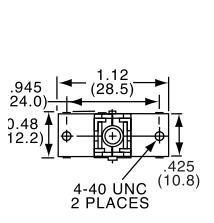

CST043NK

Part Number					
Tyco Electronics	Alcoswitch				Contact Timing
1437576-6	CST043NK	On	On	On	Non Shorting

6PDT

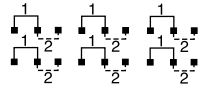
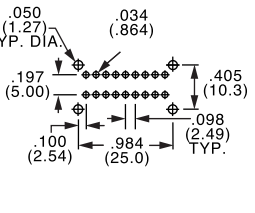
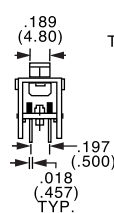
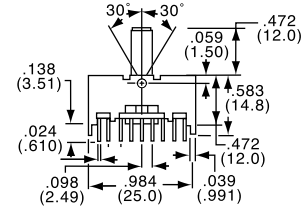
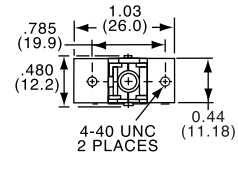

CST062NK

Part Number					
Tyco Electronics	Alcoswitch				Contact Timing
1437576-7	CST062NK	None	On	On	Non Shorting

Slide Switches, Miniature, Right Angle, Surface Mount

MATERIAL SPECIFICATIONS:

ContactsBeCu, copper alloy, 1 micron silver plate
 Case Material40% G.F. PPS, UL94V-0
 FrameStainless steel, silver plated
 Actuator MaterialNylon, UL94HB polyamide
 TerminalsBrass, copper alloy, 1 micron silver plate
 Terminal SealEpoxy

TYPICAL PERFORMANCE CHARACTERISTICS:

Contact Rating0.3 Amp, 4 VDC
 Initial Contact Resistance70 Milliohms
 Insulation Resistance100 Megohms min.
 Dielectric Strength100 VAC min.
 Actuation Force175 ±100 Grams
 Life ExpectancyUp to 10,000 Cycles
 Travel0.059 (1.5mm)

ENVIRONMENTAL SPECIFICATIONS:

HumidityMIL-STD-202, Method 103, Condition B
 Moisture ResistanceMIL-STD-202, Method 106
 Thermal ShockMIL-STD-202, Method 107, Condition A
 Solder Heat Resistance ...230°C per EIA 364-56 Level 2

SPDT

CIRCUIT DIAGRAM

MLL1200S

Part Number		
Tyco Electronics	Alcoswitch	Type
1437575-1	MLL1200S	SPDT
1437575-2	MLL1200STR	SPDT

SP3T

CIRCUIT DIAGRAM

MLL1300S

Part Number		
Tyco Electronics	Alcoswitch	Type
1437575-3	MLL1300S	SP3T

13 Amp & 6 Amp, Panel Mount

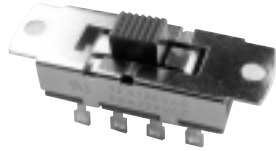

MATERIAL SPECIFICATIONS:

ContactsCopper alloy, silver plate
 BoardPhenolic, UL94V0
 FrameSteel, nickel plate
 Actuator MaterialNylon, UL94V-2
 TerminalsCopper alloy, silver plate
 Terminal SealEpoxy

ENVIRONMENTAL SEPCIFICATIONS:

Operating Temperature ..-4°F to 149°F (-20° to +65°C)
 Storage Temperature-13°F to 158°F (-25° to +70°C)
 Solder Heat Resistance ..Per EIA-364-56A, Procedure 3, Condition B
 SolderabilityPer EIA-364-52, Class 2, Category 1, 95%
 minimum coverage

TYPICAL PERFORMANCE CHARACTERISTICS:

Contact Rating13 Amp, 125 VAC or 6.5 Amp, 250 VAC
 Initial Contact Resistance.....50 Milliohms max.
 Insulation Resistance100 Megohms min.
 Dielectric Strength1200 VAC
 Actuation Force100-900 Grams
 Life ExpectancyUp to 5000 Cycles
 Travel0.236 (6.0mm)

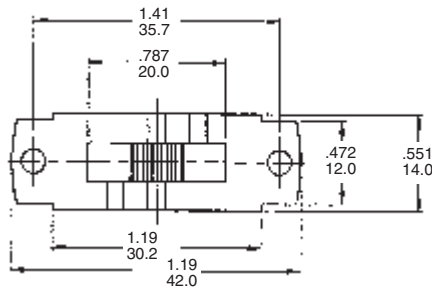

DP3T

Part Number 1571490-1

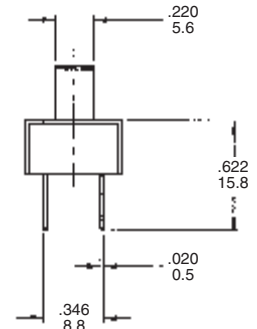
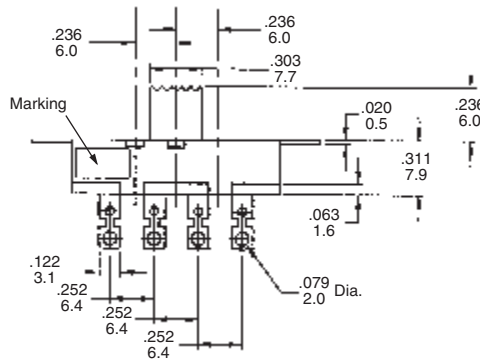

MATERIAL SPECIFICATIONS:

ContactsCopper alloy, silver plate
 BoardPhenolic, UL94HB
 FrameSteel, nickel plate
 Actuator MaterialPolycarbonate, UL94V-2
 TerminalsCopper alloy, silver plate
 Terminal SealEpoxy

TYPICAL PERFORMANCE CHARACTERISTICS:

Contact Rating6 Amp, 125 VAC or 3 Amp, 250 VAC
 Initial Contact Resistance.....50 Milliohms max.
 Insulation Resistance100 Megohms min.
 Dielectric Strength1800 VAC
 Actuation Force500-900 Grams
 Life Expectancy5000 Cycles
 Travel0.197 (5.0mm)

ENVIRONMENTAL SEPCIFICATIONS:

Operating Temperature ..-4°F to 149°F (-20° to +65°C)
 Storage Temperature-13°F to 158°F (-25° to +70°C)
 Solder Heat Resistance ..Per EIA-364-56A, Procedure 3, Condition B
 SolderabilityPer EIA-364-52, Class 2, Category 1, 95% minimum
 coverage

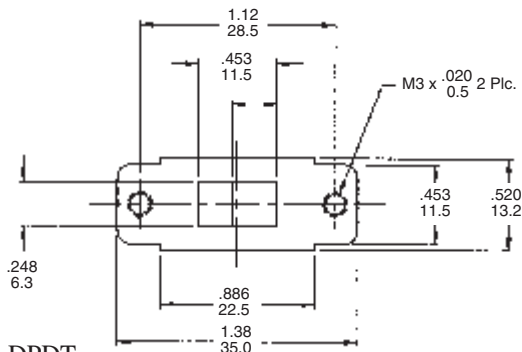

DPDT

Part Number 1571491-1

