

DETAILS

Product Number	CX14343_RITA-WAS-RZ
Family	Rita
Type	RefPack
Color	white
Diameter	35,07x28,9 mm
Height	19,25 mm
Style	rectang
Optic Material	HRPC
Holder Material	
Fastening	tape, pin
Status	production ready
ROHS Compliant	Yes
Date Updated	2/11/2016

OPTICAL PROPERTIES

LED	Viewing Angle	Light Beam	Efficiency	cd/lm	Connector
XM-L RGB	Asymmetric deg	Asymmetric	81 %	0.620	-
LUXEON Z RGB	asymmetric deg	Asymmetric	81 %	0.610	-
LUXEON C RGBW	asymmetric deg	Asymmetric	79 %	0.560	-
Ostar-SMT RGB	asymmetric deg	Asymmetric	80 %	0.590	-



D

C

B

A

Assemblies with tape	Assemblies without tape
CX14343_RITA-WAS-RZ	CN14338_RITA-WAS-RZ

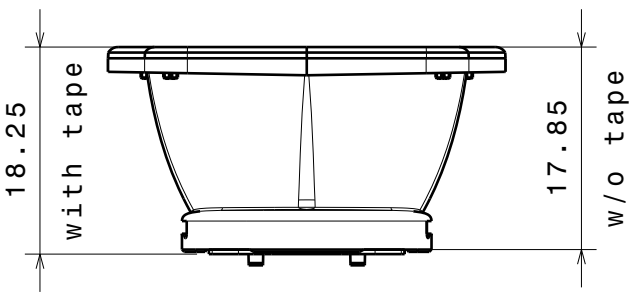

Bottom view
Scale: 3:2

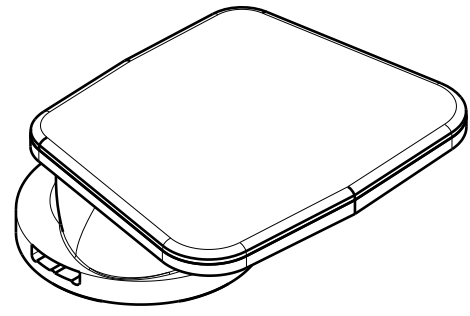

Isometric view
Scale: 3:2

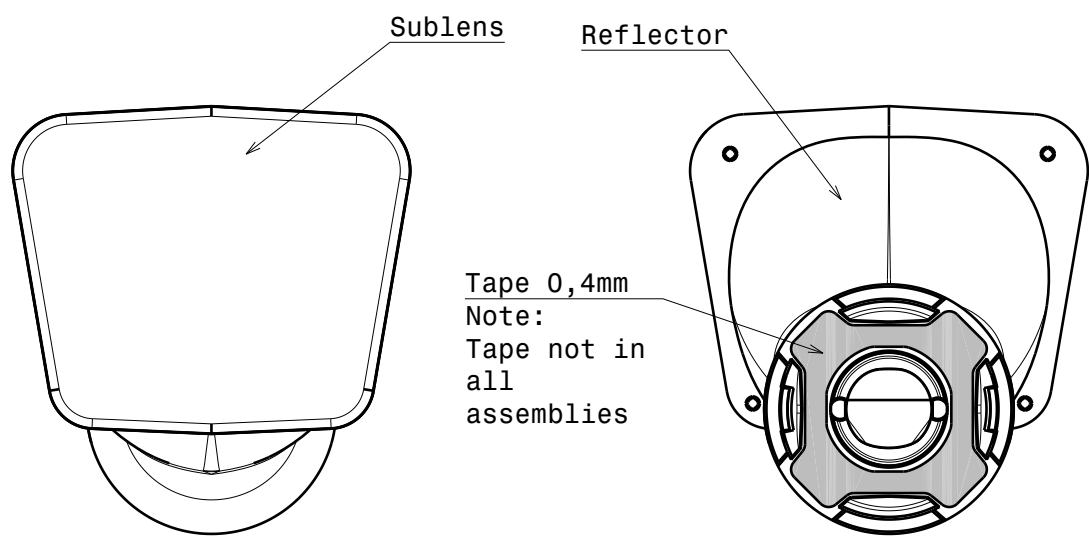

Front view
Scale: 3:2

Rear view
Scale: 3:2

Tolerances if not otherwise shown
According to DIN ISO 2768-1
Linear measures:
Up to 30mm class M, otherwise class C.
According to DIN ISO 2768-2
Form and position: class L

LEDiL LediL Oy
Salorankatu 10
FIN 24240 SALO
Finland

THIRD ANGLE PROJECTION:

DRAWING TITLE
RITA-A-RZ Assembly Drawing

This drawing is the property of LEDiL Oy. It may not be reproduced, copied or communicated without a written agreement with LEDiL Oy.

SIZE	PART NUMBER
A4	-

SCALE	3:2	WEIGHT	-	SHEET	1/1
-------	-----	--------	---	-------	-----

D

A

Luminaire: Ledil CX14343_RITA-WAS-RZ (XM-L_RGBW)

Lamps: 1 x Cree_XM-L_RGBW_(XMLCTW-A0-0000-00C3AAAA1)_212.935lm@250mA_P=2.73375W_I=0.25A

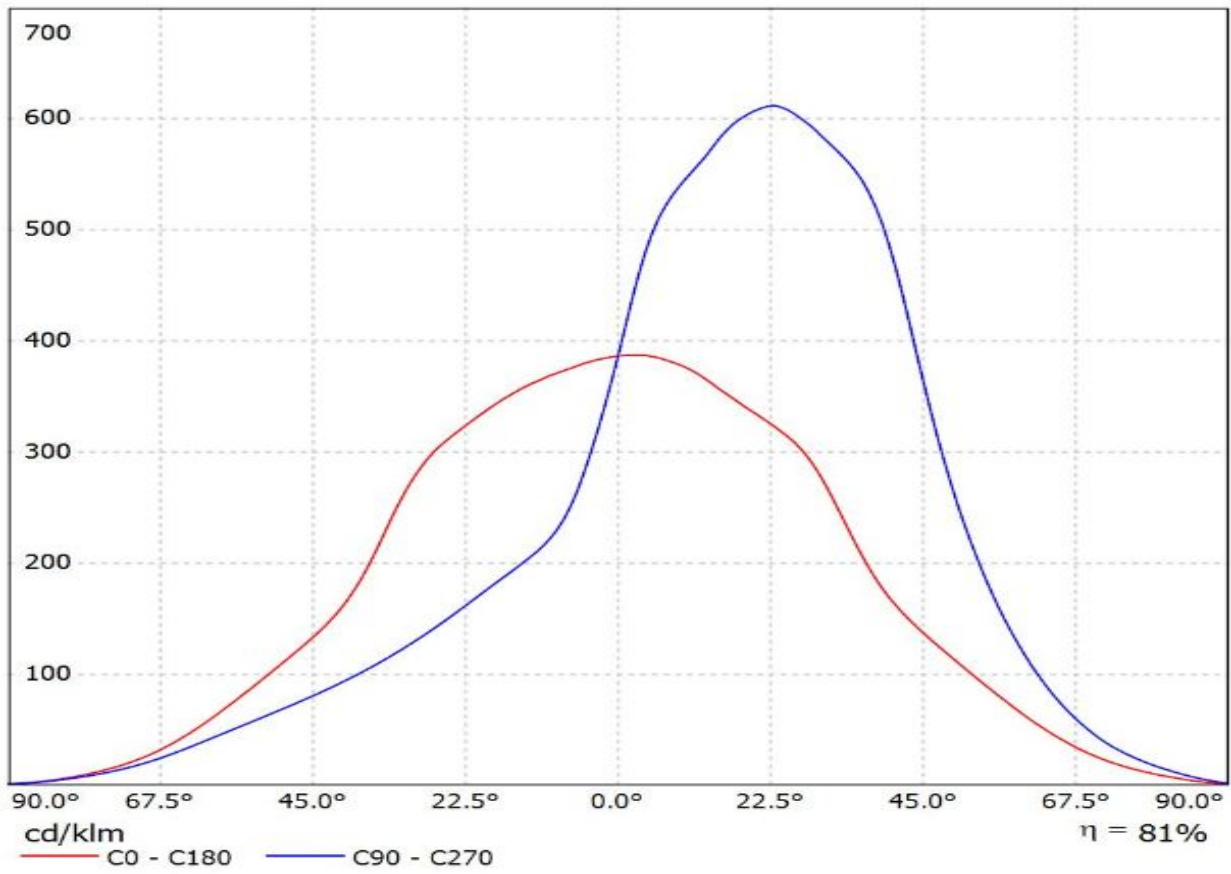

Luminaire: LEDiL Oy CX14343_RITA-WAS-RZ_(LUXEON-Z_RGB) Eff.81%
Lamps: 1 x Luxeon-Z_RGB_160.867lm@250mA_P=2.64819W_I=249.9mA

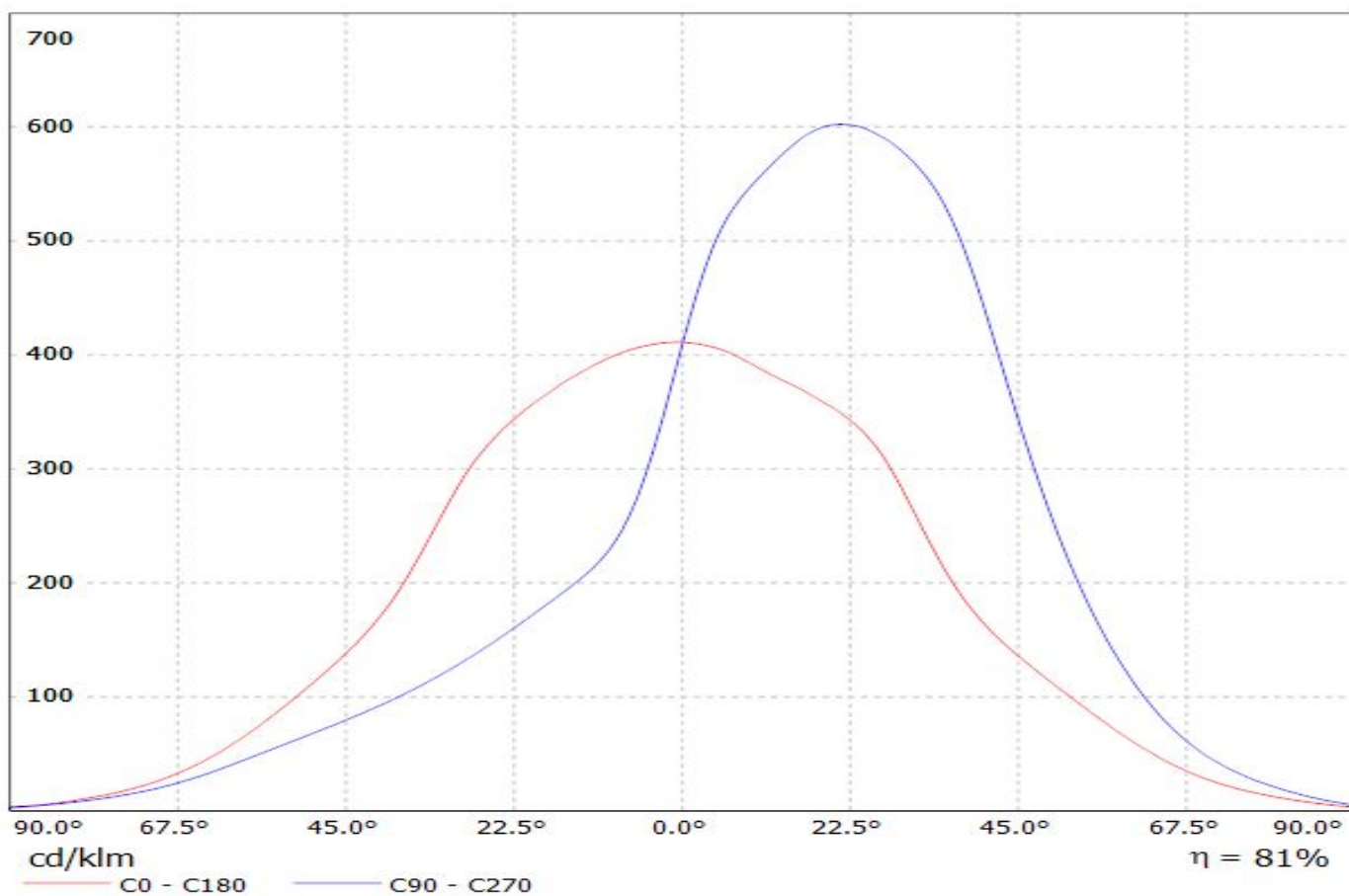

Luminaire: LEDiL Oy CX14343_RITA-WAS-RZ_(Luxeon_C_RGBW)
Lamps: 1 x Luxeon_C_RGBW_208.984lm@250mA_P=2.5474W_I=0.250A

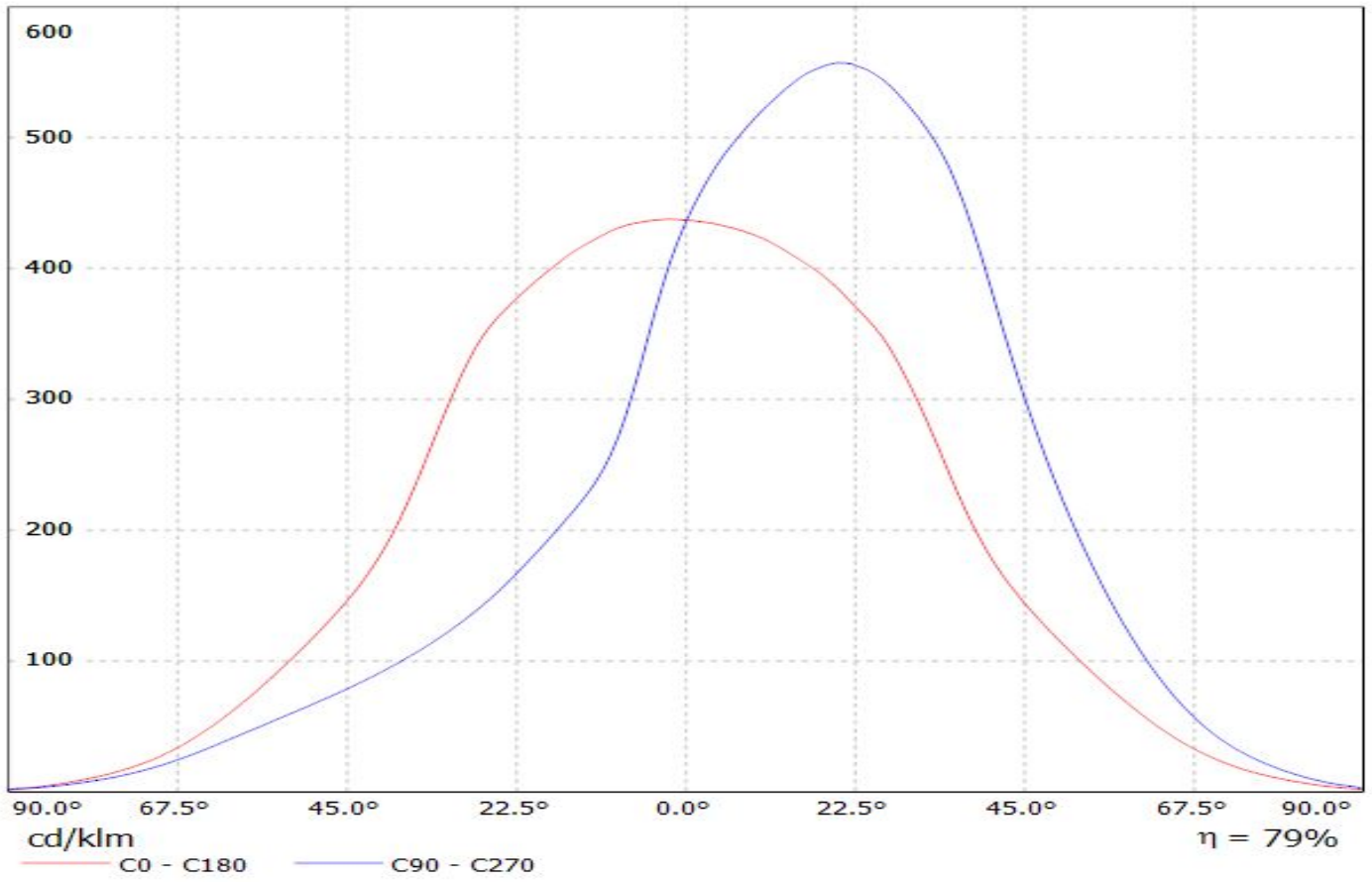

Luminaire: LEDiL Oy RITA-WAS-RZ_(OSTAR_SMT_RGB)
Lamps: 1 x OSTAR_SMT_RGB_161lm@250mA_P=2.97862W_I=249.8mA

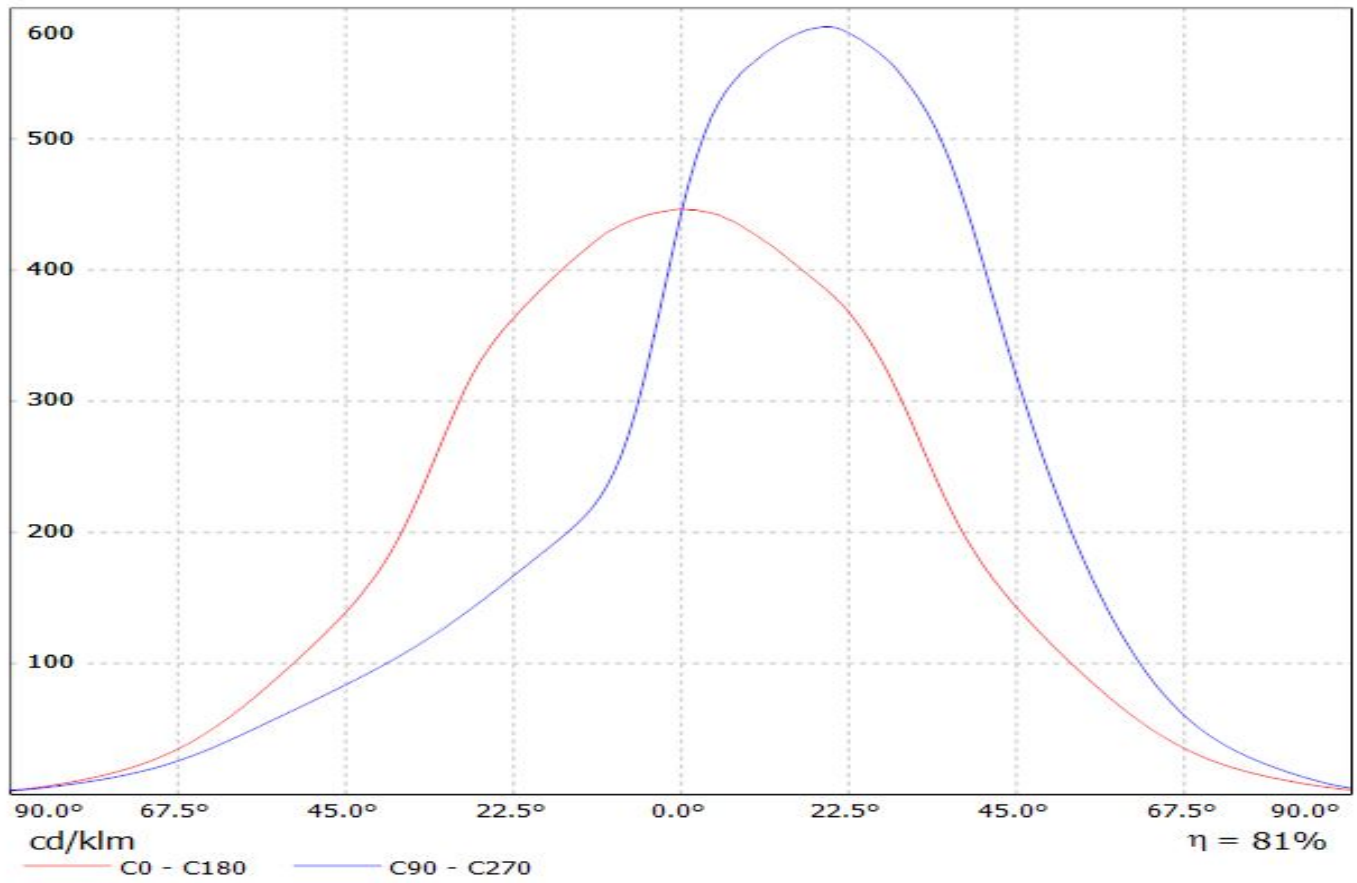

Luminaire: Ledil CX14343_RITA-WAS-RZ_(XM-L_RGBW)

Lamps: 1 x Cree_XM-L_RGBW_(XMLCTW-A0-0000-00C3AAAA1)_212.935lm@250mA_P=2.73375W_I=0.25A

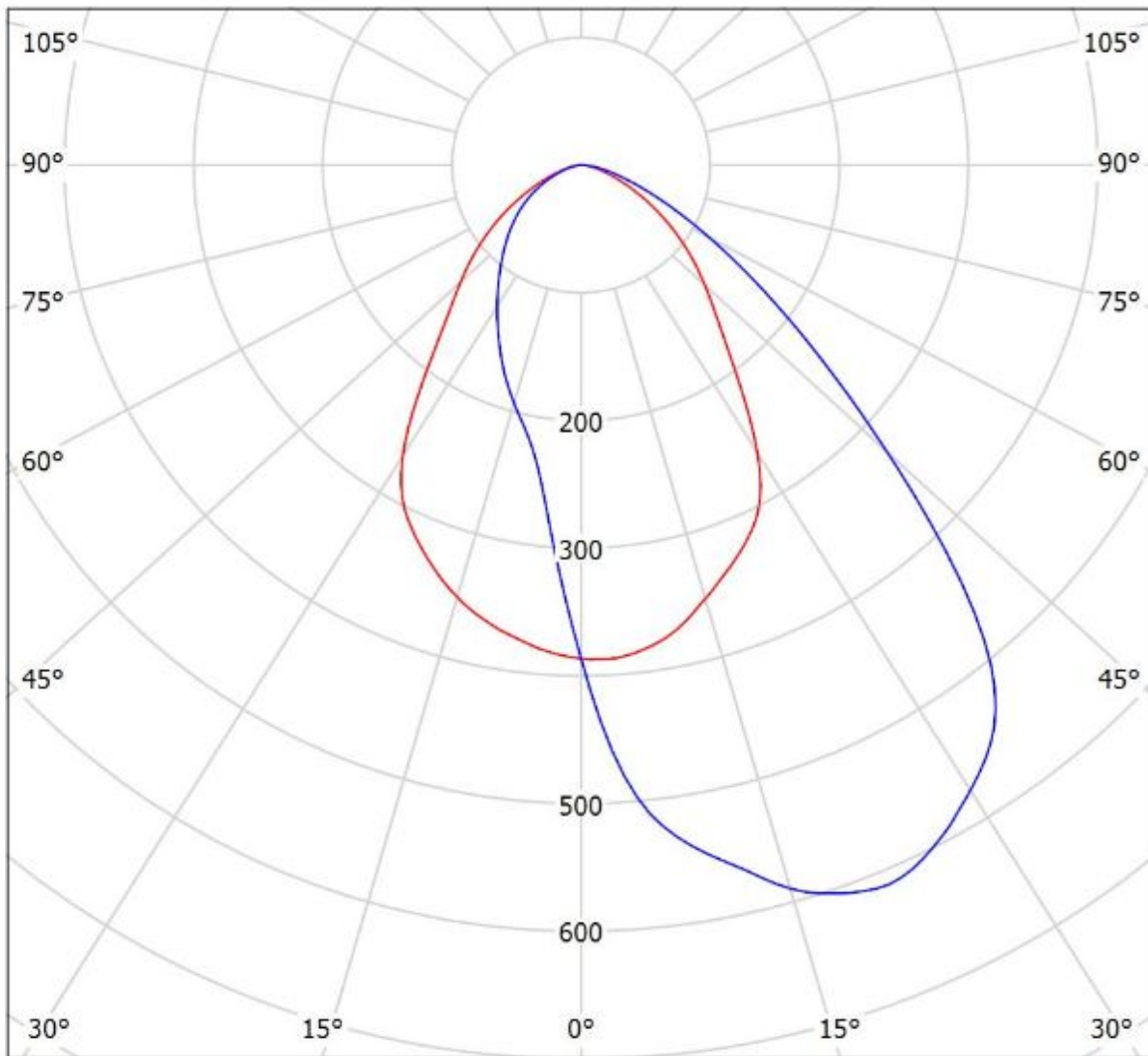

cd/klm
— C0 - C180 — C90 - C270

$\eta = 81\%$

Luminaire: LEDiL Oy CX14343_RITA-WAS-RZ_(LUXEON-Z_RGB) Eff.81%
Lamps: 1 x Luxeon-Z_RGB_160.867lm@250mA_P=2.64819W_I=249.9mA

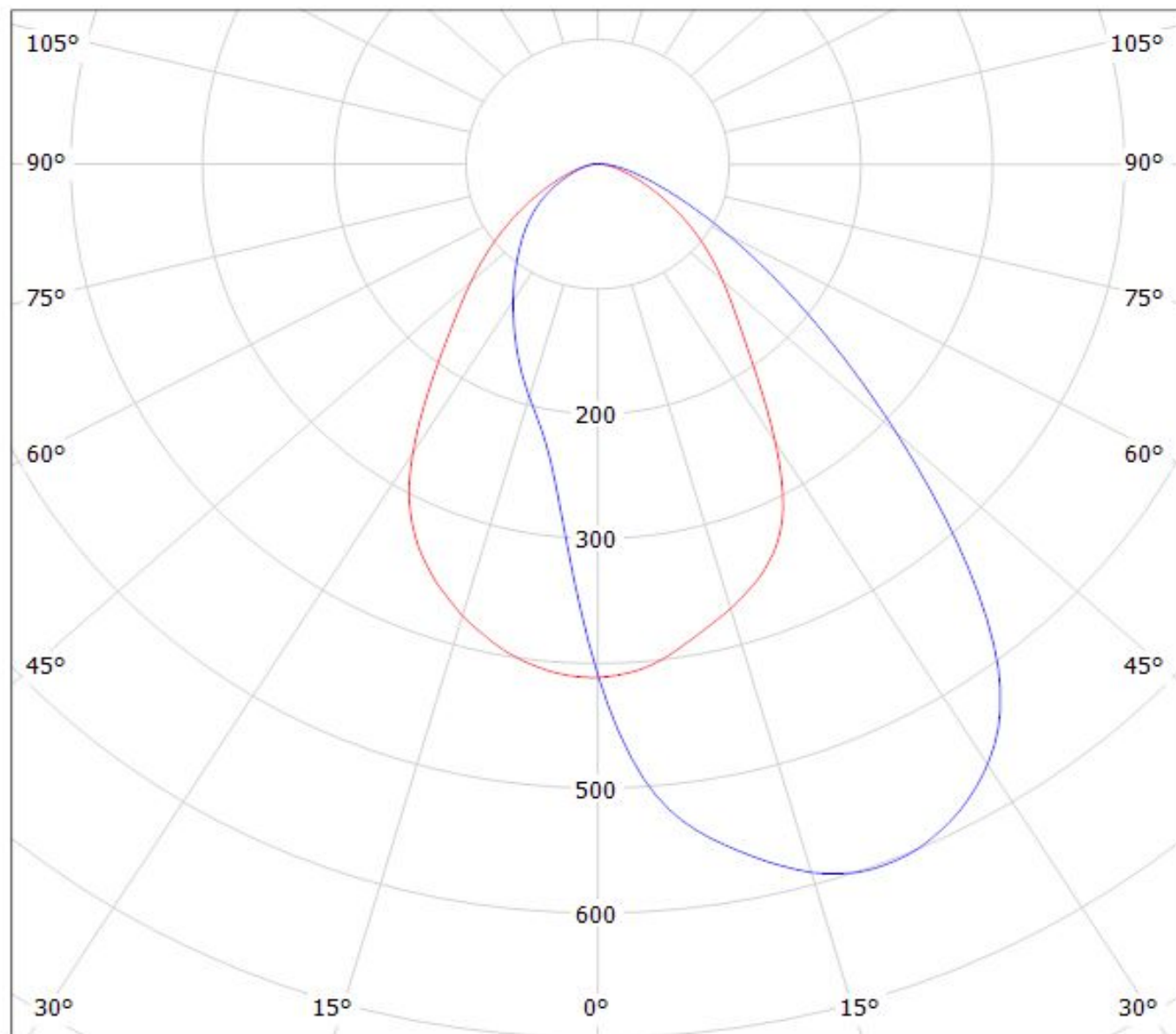

cd/klm

— C0 - C180 — C90 - C270

$\eta = 81\%$

Luminaire: LEDiL Oy CX14343_RITA-WAS-RZ_(Luxeon_C_RGBW)

Lamps: 1 x Luxeon_C_RGBW_208.984lm@250mA_P=2.5474W_I=0.250A

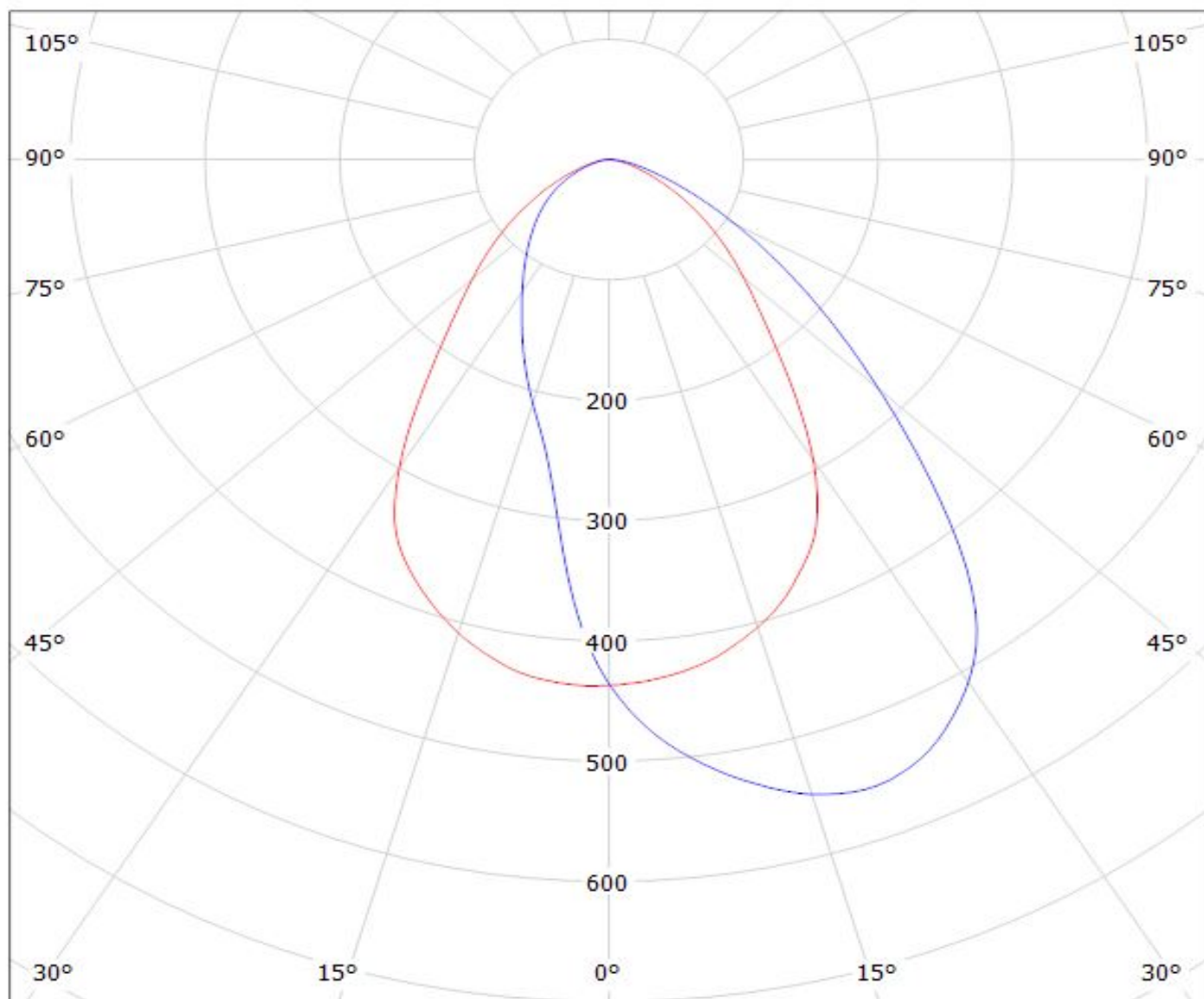

cd/klm

— C0 - C180

— C90 - C270

$\eta = 79\%$

Luminaire: LEDiL Oy RITA-WAS-RZ_(OSTAR_SMT_RGB)
Lamps: 1 x OSTAR_SMT_RGB_161lm@250mA_P=2.97862W_I=249.8mA

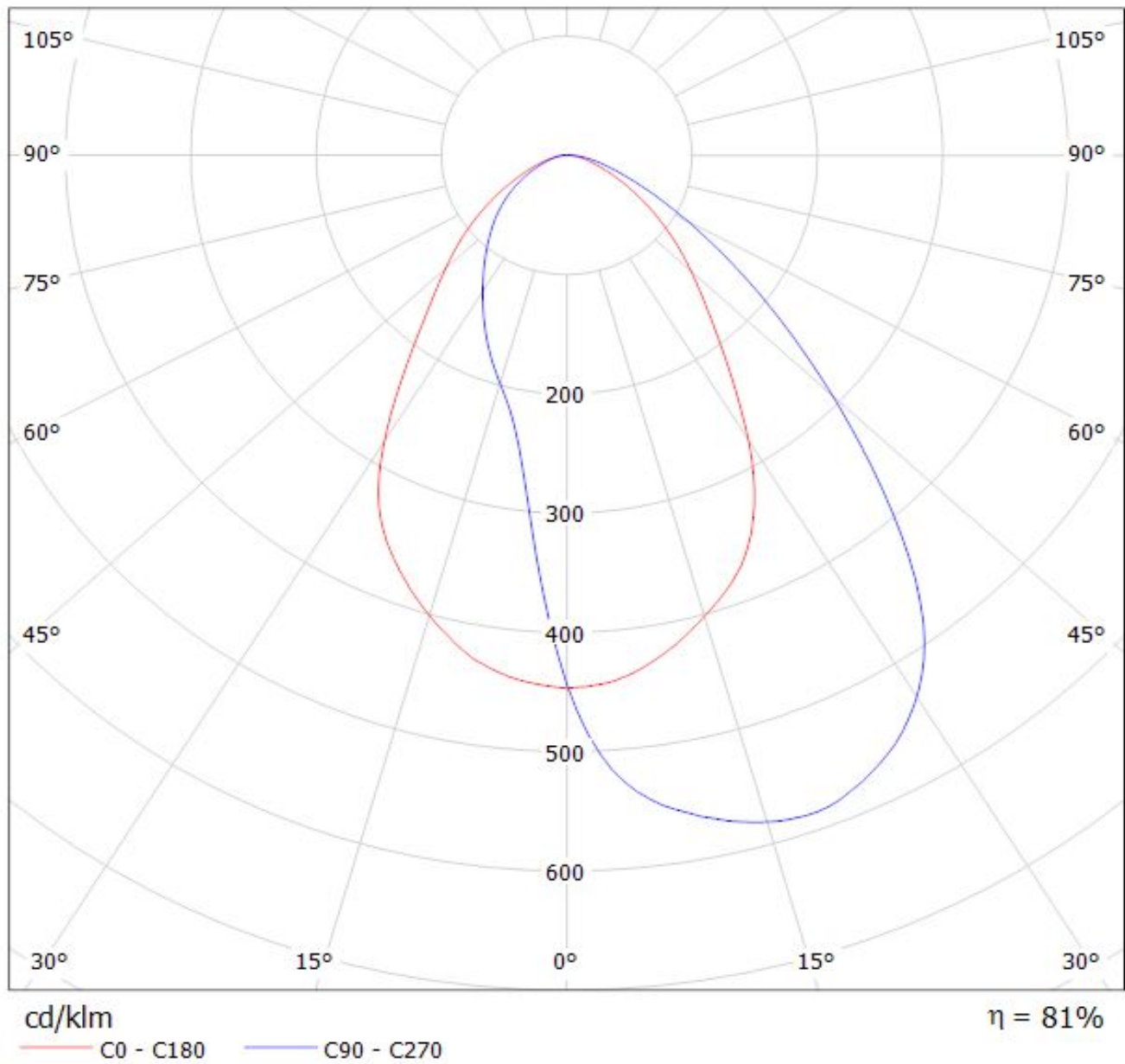

NOTE: The typical divergence will be changed by different color, chip size and chip position tolerance. The typical total divergence is the full angle measured where the luminous intensity is half of the peak value.