

MOD BLOCK - 2X2 Standard

IP67-Rated Module built with Cree XHP50 LEDs

Primary Applications



High Mast	Canopy
Streetlight	Garage
Stadium	Portable
Architectural	High bay

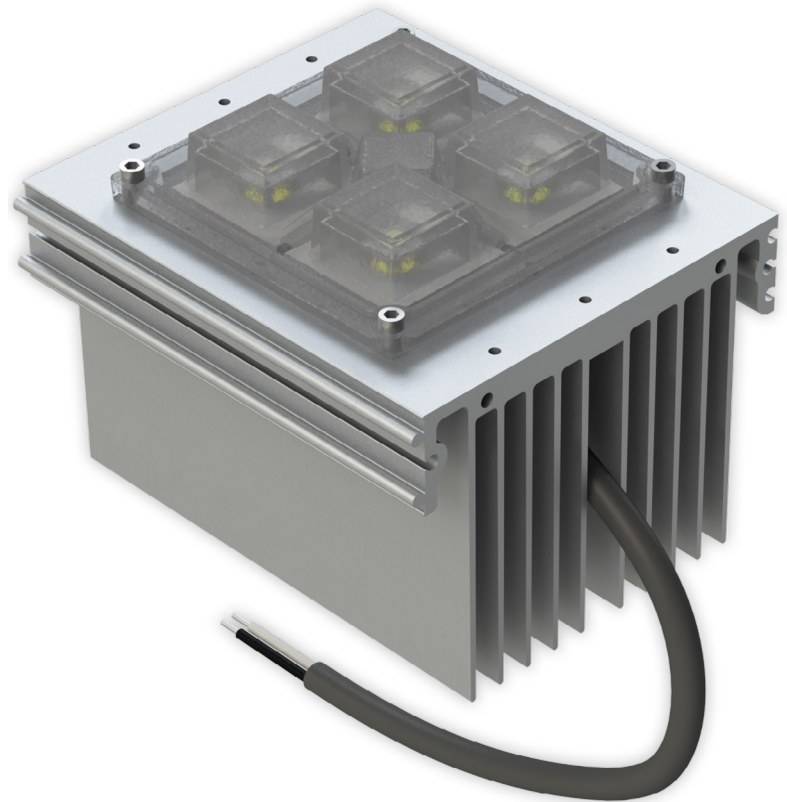

Features and Benefits

- IP67 Protection – Self-contained module for outdoor applications or other difficult environments
- Optical Flexibility – a variety of off-the-shelf optical patterns are available
- Integrate Further – Easy to add multiple modules through our interlocking technology
- Easy Mounting – designed for quick mounting to a housing or bracket
- Performance – industry leading lumen density and lumens per pound
- Certifications – UL recognized component (E482308) and RoHS compliant
- Custom - private label or design changes available

Introducing the Opulent Americas IP67 rated LED heat sink module using Cree XHP50 Extreme High Power LEDs. This Opulent Americas module is engineered to bring high quality lighting systems to market faster with fewer LEDs, higher reliability, and a lower system cost. This module is a robust, flexible, and versatile building block for any number of lighting systems such as high bay, low bay, parking, and stadium lighting.

Interlocking Technology to Add More Modules

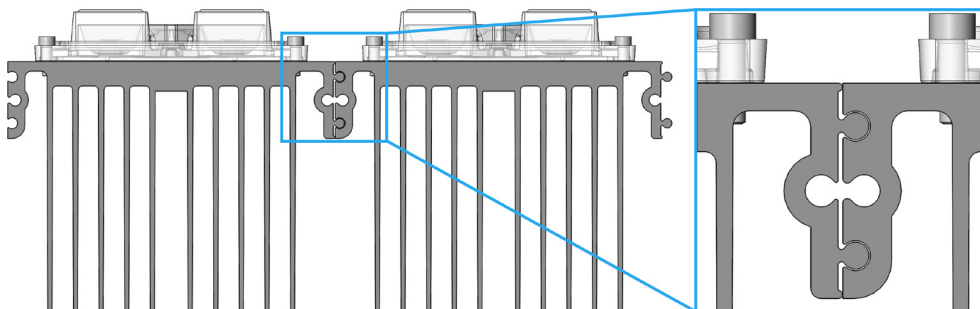

Last Modified: 03/21/17

RoHS 

MOD BLOCK - 2X2 Standard Specifications

Order Code Formatting

Series	-	Color Temperature	Color Rendering Index	-	Optic	-	Cable Type	-	Internal Code
MS22T1 -C21 - XHP50 Mod Block		27 - 2700K	70 - 70 CRI		M		1 - Cable Pigtail		XX
		30 - 3000K	80 - 80 CRI		W		2 - Waterproof M15 Cable		
		40 - 4000K	90 - 90 CRI		WWW				
		50 - 5000K			T2 ⁽¹⁾				
		57 - 5700K			T2S				
					T4B ⁽¹⁾				
					VSM				
					DWC				
					SCL				

⁽¹⁾ T2 & T4B optics coming soon

*See Page 5 for Photometric Distributions

MOD BLOCK - 2X2 Standard Specifications

Ordering Information

Part Number	CCT	CRI	Binning	Forward Voltage (V)	Current (mA)	Luminous Flux (lm)	Efficacy Nominal (lm/W)	Watts (W)
MS22T1 -C21-5770-x	5700K	70	ANSI	47.2	700	4502	136	33.0
	5700K	70	ANSI	48.1	1050	6108	121	50.5
	5700K	70	ANSI	49.0	1500	7709	105	73.5
MS22T1 -C21-5070-x	5000K	70	5-Step	47.2	700	4502	136	33.0
	5000K	70	5-Step	48.1	1050	6108	121	50.5
	5000K	70	5-Step	49.0	1500	7709	105	73.5
MS22T1 -C21-4070-x	4000K	70	5-Step	47.2	700	4502	136	33.0
	4000K	70	5-Step	48.1	1050	6108	121	50.5
	4000K	70	5-Step	49.0	1500	7709	105	73.5

*Product performance based on 25°C ambient temperature

Ratings

Parameter	Unit	Rating
Solder Point Temperature	Degrees	105
Operating Temperature	degrees	-40 to +50
Weight	G	865

MOD BLOCK - 2X2 Standard Specifications

Spatial Distribution

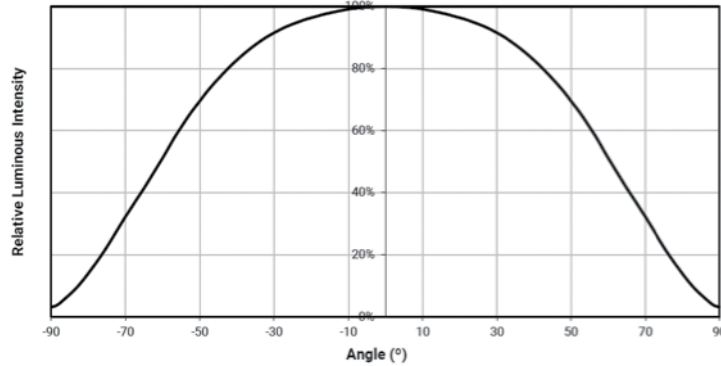

Performance Groups – Chromaticity

Binning	CCT	X	Y
ANSI	5700K	0.3207	0.3462
		0.3376	0.3616
		0.3366	0.3369
		0.3222	0.3243

Binning	CCT	Center Point		Major Axis		Rotation Angle (°)
		X	Y	a	b	
5-Step	5000K	0.3447	0.3553	0.01400	0.00520	65.0
5-Step	4000K	0.3818	0.3797	0.001420	0.00550	61.5

MOD BLOCK - 2X2 Standard Specifications

Photometric Distributions

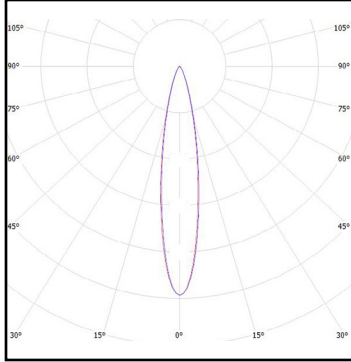

M - Strada-2X2MX-M

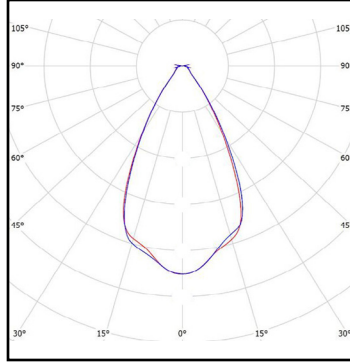

W - Strada-2X2MX-W

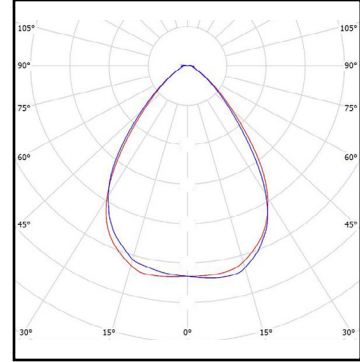

WWW - Strada-2X2MX-WWW

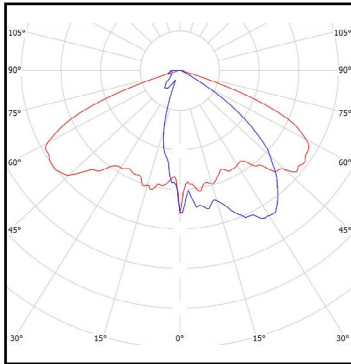

T2S - Strada-2X2MX-T2S

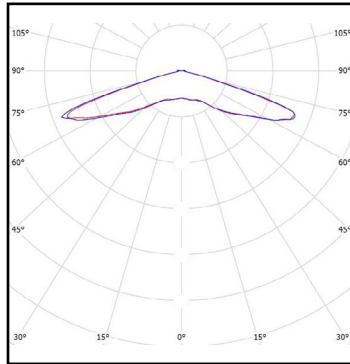

VSM - Strada-2X2MX-VSM

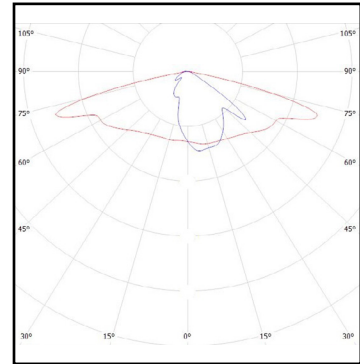

DWC - Strada-2X2MX-DWC

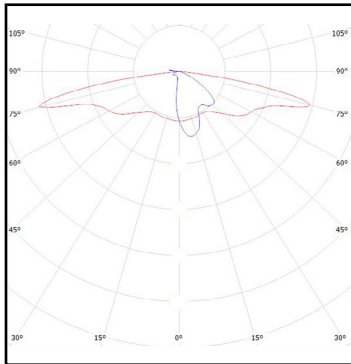

SCL - Strada-2X2MX-SCL

MOD BLOCK - 2X2 Standard Specifications

Mechanical Dimensions

