

3.3 (0.13)
2.35 (0.093)
0.8 (0.032)
0 (0)

K-K

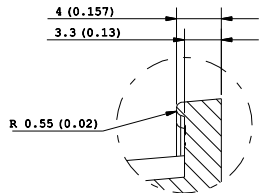

Dettaglio: A
Scala 3:1

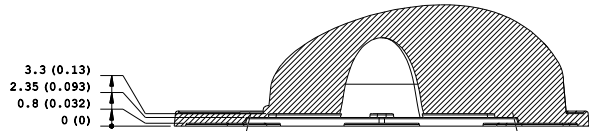
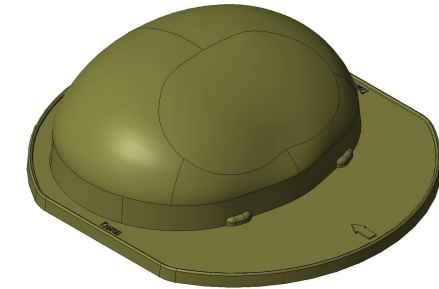
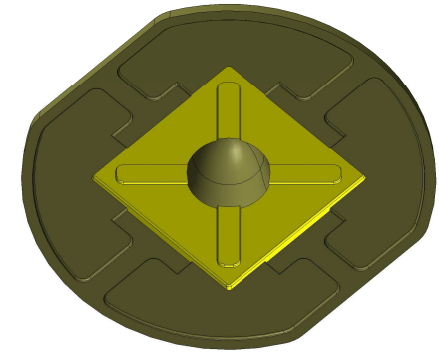
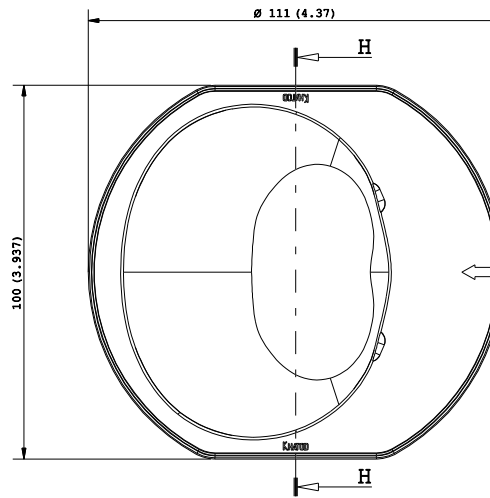
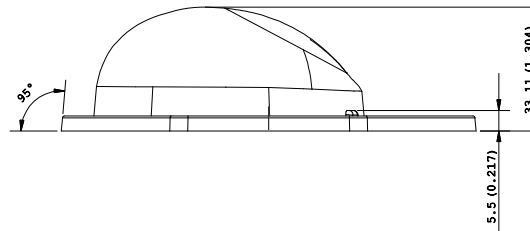
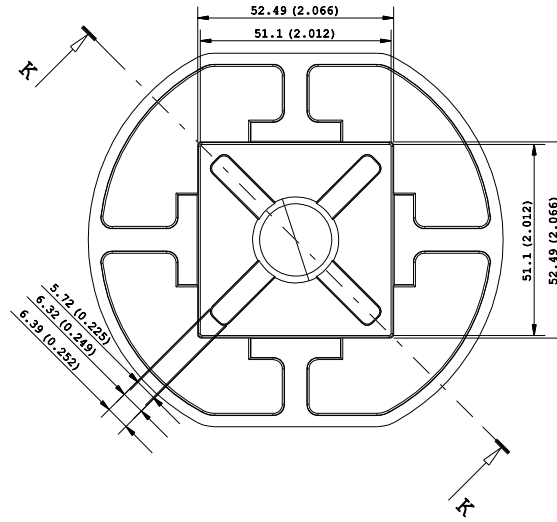
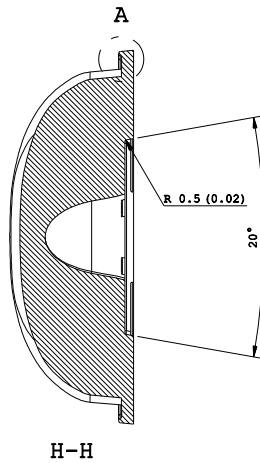

Note:
- Dimensions in inches into brackets
- For missing dimensions see 3D file

"Progetto e disegno di proprietà della KHATOD OPTOELECTRONIC s.r.l. Le soluzioni tecniche adottate in questo disegno sono di nostra esclusiva proprietà e quindi, a norma delle vigenti leggi, ne è vietata la riproduzione e la veicolazione a terzi senza nostra autorizzazione scritta."

PARTICOLARE : LENS		DISEGNATORE : LM/DP		PROGETTO : SIL
CODICE : PL 1771 SR		VISTO : LM/GV	CONTR: SB/DP	DATA : 18/01/2014
KHATOD Via Monfalcone, 41 Cinisello Balsamo MILANO ITALIA WWW.KHATOD.COM		Tutte le dimensioni in mm. Toll. Gen. +/- 0.35 mm		TRATTAMENTI TERMICI: No One
				MATERIALE: LSR clear
		SCALA : 1 : 1		FOGLIO : 1 of 1