

PROPER USE GUIDELINES

Cumulative Trauma Disorder can result from the prolonged use of manually powered hand tools. NorComp hand tools are intended for the occasional use and low volume applications. NorComp offers a wide selection of powered application equipment for extended use, production operations.

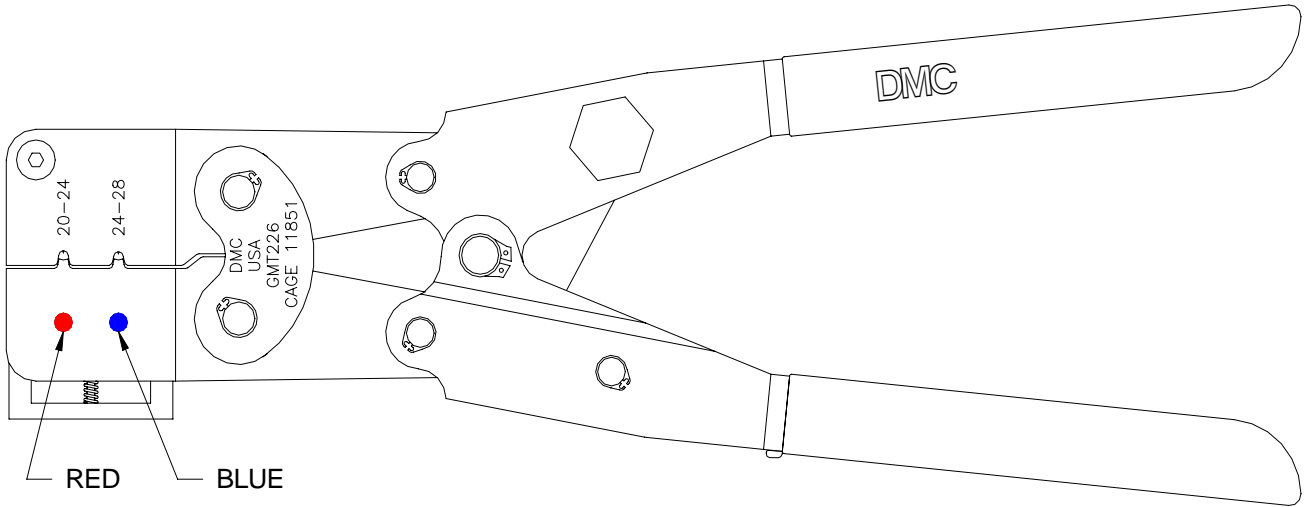

HAND TOOL	CONTACT SIZE RANGE (AWG)	WIRE INSULATION DIAMETER Max in. [mm]	STRIP LENGTH in. [mm]
170-701-170-000	28-24	0.040 [1.02]	0.100 [2.54]

Figure 1

1. INTRODUCTION

NorComp 170-701-170-000 Hand Tool Assembly consists of Die Assembly and Hand Tool Frame.

CAUTION *Read these instructions thoroughly before crimping any contacts.*

2. DESCRIPTION

The tool features a tool frame with a stationary jaw and handle, moving jaw, and moving handle. The tool frame holds a die assembly with two crimping chambers.

The die assembly features a wire anvil, insulation anvil, wire crimper, and insulation crimper.

NOTE: Use 24-28 crimp section only for contacts:
170-001-170L001 / 170-101-170L001
170-002-170L001 / 170-102-170L001

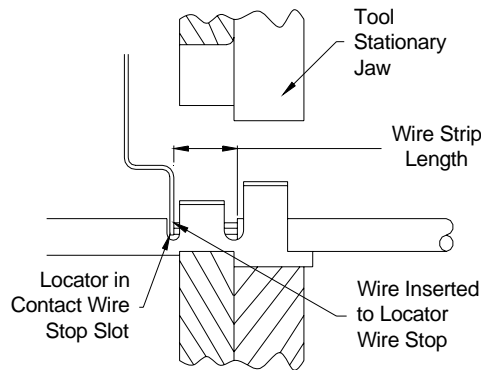

Figure 2

3. CRIMPING PROCEDURE

Strip the wire to the length indicated, taking care not to nick or cut the wire strands. Select an applicable contact and identify the appropriate crimping chamber according to the wire size (24-28) markings on the tool.

Refer to Figure 2, and proceed as follows:

1. Hold the tool so that the front is facing you. Squeeze tool handles together and allow them to open fully.
2. Insert the contact (mating end first) into the hole in the locator which corresponds with the appropriate crimping chamber. Make sure that the open "U" of the wire barrel and insulation barrel face the stationary jaw.

CAUTION *Make sure that both sides of the contact insulation barrel are started evenly into the crimping chamber. Do NOT attempt to crimp an improperly positioned contact.*

3. Hold the contact in position, and squeeze the tool handles together until ratchet engages sufficiently to hold the contact in position. Do NOT deform insulation barrel or wire barrel.
4. Insert stripped wire into contact insulation and wire barrels until wire and insulation are visible in inspection window, as shown in Figure 2.

5. Holding the wire in place, squeeze the tool handles together until ratchet releases. Allow tool handles to open and remove crimped contact.

4. CRIMP PULL TEST

1. Refer to Section 3, CRIMPING PROCEDURE, and crimp the contact accordingly to achieve pull test in Figure 3.

WIRE SIZE Max AWG	TEST PULL lb.
28	4
26	6
24	8

Figure 3

5. CRIMP ADJUSTMENT

1. See Manufacturers data sheet (GMT-DS) supplied with hand tool.

6. DAILY MAINTENANCE

Properly crimped terminals are controlled by the following maintenance and inspection procedures.

1. Clean all dust, dirt, moisture and other foreign matter from the crimp jaws that could damage the crimp area of the dies.

DO NOT immerse tool in cleaning solution

2. The pivot pin and ratcheted pawl-bearing surface should be lubricated to ensure a smooth operation.

DO NOT spray oil into tool to lubricate

3. When storing the tool, close the handles until the ratchet pawl is about to be released from the tooth of the ratchet. This will help prevent the dies from being damaged.

7. VISUAL INSPECTION

The crimping dies should be inspected on a regular basis to ensure that they have not become worn or damaged.

1. Clean tool die area with solvent or brush.

DO NOT immerse tool in cleaning solution

2. Check crimp area of die for damages.
3. If tool jams or locks, check the ratchet for dirt and lubrication.

8. CARE OF TOOL

There is virtually no maintenance required. However, it is a good practice to keep indenter tips free of residual color band deposits and other debris. A small wire brush may be used for this purpose.

WE STRONGLY RECOMMEND THAT YOU
DO NOT:

- immerse tool in cleaning solution
- spray oil into tool to lubricate
- attempt to disassemble tool or make repairs

THIS IS A PRECISION HAND CRIMPING TOOL
AND SHOULD BE HANDLED AS SUCH