

## Heat Pipes

Contact:  
Wakefield-Vette  
33 Bridge St.  
Pelham, NH 03076  
603-635-2800  
info@Wakefield-Vette.com

[www.Wakefield-Vette.com](http://www.Wakefield-Vette.com)

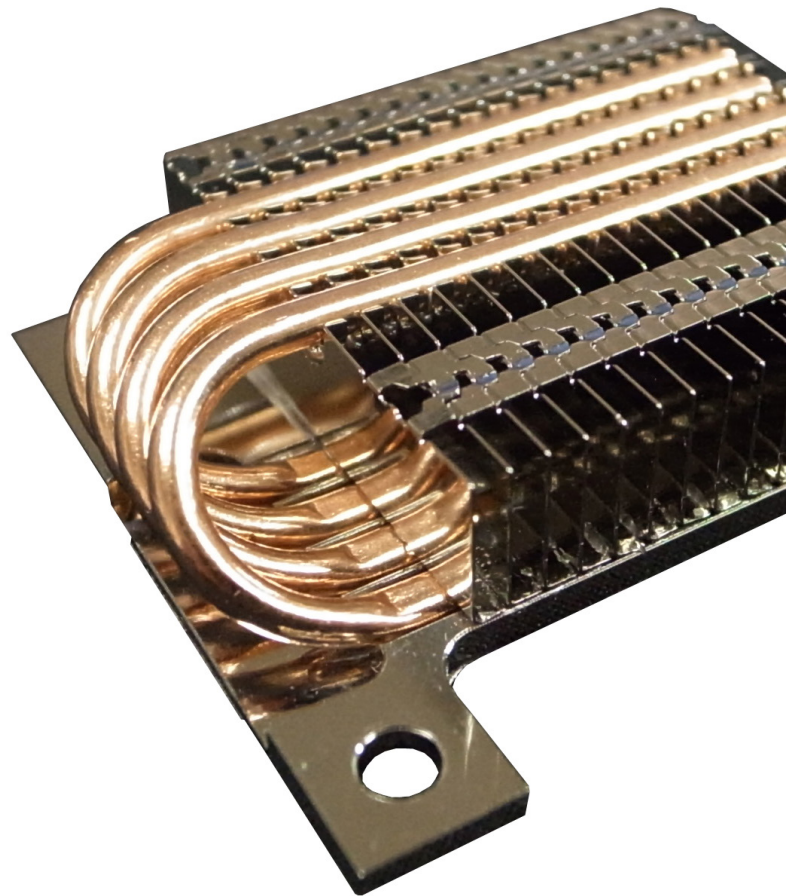

### Maximum Heat Transfer Table ( Powder Type )

HEAT PIPE LENGTH = 150mm

Q <sub>max</sub> / Out Diameter / Type	Out Diameter Φ 3 mm	Out Diameter Φ 4 mm	Out Diameter Φ 5 mm	Out Diameter Φ 6 mm	Out Diameter Φ 8 mm
Flatten t=2.0mm	13.2 W	16.6 W	20.5 W		
Flatten t=2.5mm	13.2 W	19.8 W	23.6 W	34.0 W	51.5 W
Flatten t=3.0mm	13.1 W	19.8 W	28.4 W	39.2 W	67.5 W
Round Pipe	13.2 W	19.8 W	30.1 W	48.1 W	74.2 W

### Maximum Heat Transfer Table ( Powder Type )

HEAT PIPE LENGTH = 200mm

Q <sub>max</sub> / Out Diameter / Type	Out Diameter Φ 3 mm	Out Diameter Φ 4 mm	Out Diameter Φ 5 mm	Out Diameter Φ 6 mm	Out Diameter Φ 8 mm
Flatten t=2.0mm	9.2 W	13.1 W	16.0 W		
Flatten t=2.5mm	10.5 W	13.0 W	18.0 W	22.1 W	30.0 W
Flatten t=3.0mm	10.5 W	13.2 W	19.5 W	31.0 W	44.5 W
Round Pipe	11.5 W	14.5 W	22.5 W	39.0 W	55.6 W

### Maximum Heat Transfer Table ( Powder Type )

HEAT PIPE LENGTH = 250mm

Q <sub>max</sub> / Out Diameter / Type	Out Diameter Φ 3 mm	Out Diameter Φ 4 mm	Out Diameter Φ 5 mm	Out Diameter Φ 6 mm	Out Diameter Φ 8 mm
Flatten t=2.0mm	7.2 W	10.1 W	12.2 W		
Flatten t=2.5mm	8.1 W	11.2 W	13.1 W	16.5 W	23.0 W
Flatten t=3.0mm	8.2 W	12.1 W	14.1 W	22.0 W	37.0 W
Round Pipe	9.0 W	12.3 W	15.6 W	29.3 W	45.0 W

### Size of Flattened Heat Pipes

Diameter (mm)	Thickness (mm)	Width (mm)	Tolerance (mm)
4 mm	3	4.65	+/- 0.15
	2.5	5	+/- 0.15
	2	5.23	+/- 0.15
5 mm	3.5	5.97	+/- 0.15
	3	6.25	+/- 0.15
	2.5	6.55	+/- 0.15
	2	6.83	+/- 0.15
6 mm	4	7.3	+/- 0.15
	3.5	7.58	+/- 0.15
	3	7.84	+/- 0.15
	2.5	8.1	+/- 0.15
8 mm	6	9.35	+/- 0.15
	5	9.95	+/- 0.15
	4	10.5	+/- 0.15
	3	10.99	+/- 0.15

### Heat Pipe Types And Comparison

Heat Pipe Type	Advantage	Disadvantage
<b>Powder Type</b>	<ol style="list-style-type: none"> <li>1.The best for heat transfer.</li> <li>2.Better quality reliability.</li> <li>3.Workable for any operation direction.</li> <li>4.Easy for bending &amp; flatten.</li> </ol>	<ol style="list-style-type: none"> <li>1.Higher cost.</li> <li>2.Difficult to produce.</li> <li>3.Flattening limitation (2mm).</li> </ol>
<b>Mesh Type</b>	<ol style="list-style-type: none"> <li>1.Lower cost.</li> <li>2.Quick heat response.</li> <li>3.Workable for any operation direction.</li> </ol>	<ol style="list-style-type: none"> <li>1.Poor Heat transfer.</li> <li>2.Uneasy for after-process of bending and pressing.</li> <li>3.Quality may vary after bending.</li> <li>4.Heat transfer rate is limited if pipe size larger than 5mm.</li> </ol>
<b>Groove Type</b>	<ol style="list-style-type: none"> <li>1.Lower cost.</li> <li>2.Quick heat response.</li> <li>3.Most workable for pressing.</li> </ol>	<ol style="list-style-type: none"> <li>1.Heat transfer is fair.</li> <li>2.Not easy for after-process bending and flattening.</li> <li>3.Not workable for negative operation direction.</li> </ol>

### R-Angle

	Min.R	Decline	Suggested	Decline	Min. Bending Angle	Suggested
4	10	20%	12	10%	> 90°	> 120°
5	12	20%	15	10%		
6	15	30%	18	15%		
6.35	18	30%	19	15%		
8	24	30%	32	15%		
9.6	29	40%	38	15%		

## Standard Operation Procedure

### The First $\Delta T$ Test in Test Fixture for the Round Heat Pipes

#### Test procedure:

1. Adjust a test fixture interval of the tested heat pipe.
2. Turn on the power switch on the control panel.
3. Set the test temperature at 70°C.
4. Turn on the computer and input the  $\Delta T$  (T1-T2), lot number, and length of the tested heat pipes.
5. Put the untested heat pipe on the test fixture.
6. Press the start button to test  $\Delta T$  (T1-T2).

#### Acceptance Standard:

1. If a heat pipe length is less than 150 mm,  $\Delta T \leq 3^{\circ}\text{C}$  it passes.
2. If a heat pipe length is larger than 150 mm,  $\Delta T \leq 4^{\circ}\text{C}$  it passes.

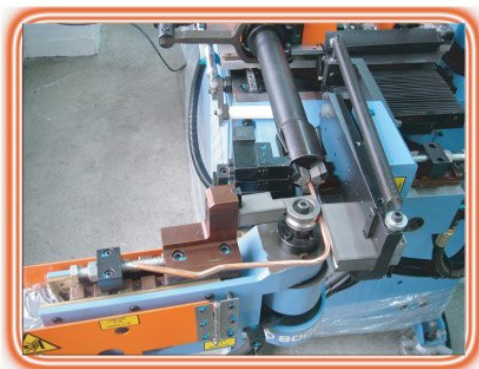
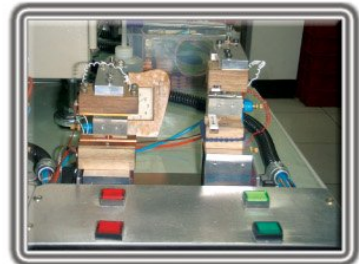
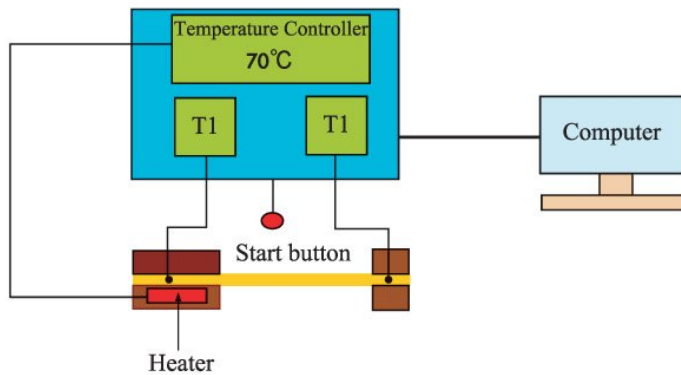

**Heat Pipe Bending Machine**  
熱管折彎機



**Reflow Oven** 回焊爐車間



## The Second $\Delta T$ Test in Water Container for the flatten or Bend Heat Pipes

### Test procedure:

1. Turn on the switch of the temperature controller and set testing temperature at 70°C
2. Put a thermal couple into the water (T1).
3. Attach a thermal couple (T2) below soldering end of a heat pipe 10~15 mm.
4. Put 1/3 length of the untested heat pipe into water of 70°C to test its  $\Delta T$  (T1-T2).
5. If heat pipe passes  $\Delta T$  test, submerge heat pipe in alcohol.
6. Take out and let air dry.

### Acceptance Standard:

1. If a heat pipe length is less than 150 mm,  $\Delta T \leq 4^\circ\text{C}$  it passes.
2. If a heat pipe length is larger than 150 mm,  $\Delta T \leq 5^\circ\text{C}$  it passes.

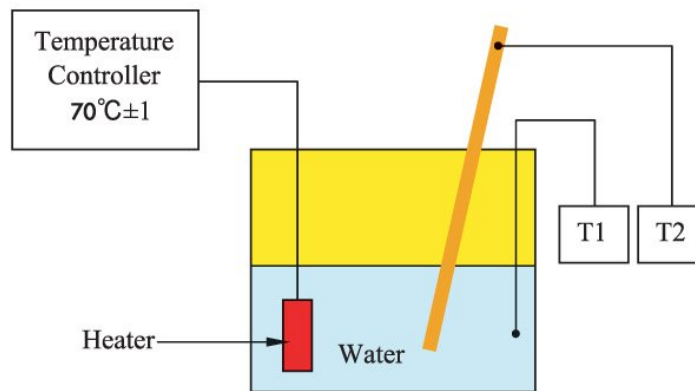

**Heat Pipe & Stamping Fin Process**  
熱管組合鳍片



**Sinter 熱管燒結**

## QMAX Test Procedure for Vette Heat Pipes

### Purpose:

Check QMAX of a heat pipe at specific temperature.

### Test apparatus:

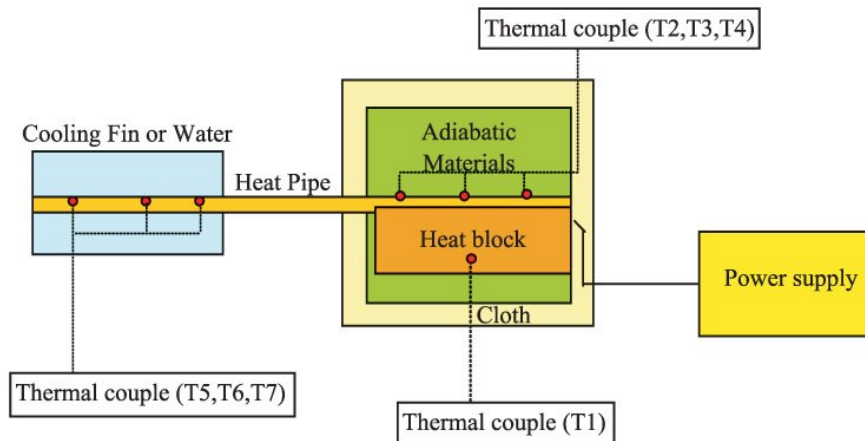

**Power supply:** Provide power for heaters to heat the heat block.

**Heat block:** Simulated CPU to heat the heating end of a heat pipe.

**Cooling Fin or Water Jacket:** Disperse heat energy to surroundings.

**Adiabatic material and cloth:** Prevent heat energy from disappearing to surroundings.

**Thermal couple:** Measure the point temperature at a designated location.

In this test apparatus, three point temperatures including heat block (T1), heating end (T2) and cooling end (T7) of the heat pipe are measured.

**$\Delta T = T2 - T7$ :** Temperature difference between the heating end and cooling end of a heat pipe.

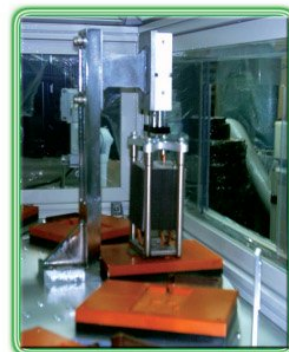

**Air Pressure Jar** 氣壓缸

## QMAX Test Procedure for Vette Heat Pipes

### Procedure:

1. Put the heating end of a heat pipe on a heat block with heaters.
2. Use adiabatic materials to surround the heat block and the heating end.
3. Wrap a cloth around the adiabatic materials.
4. Provide the test power for the heaters by a power supply.
5. Heat up the heating end of the heat pipe to temperature 70°C and dissipate heat generation at another end of heat pipe by a cooling fin or water jacket.
6. Measure the temperature difference ( $\Delta T$ ) between two ends of the heat pipe.
7. While the  $\Delta T=4^{\circ}\text{C}$ , the maximum power (QMAX) of heat transfer of the heat pipe is obtained.

### \* Pass/Failure:

$Q_{MAX} \geq$  Customer requirement then heat pipe is passed

### \* Test frequency:

One piece per lot or according to customer request

### Note:

In our test apparatus, this material is to ensure maximum heat transfer through the heat pipe.

