

AIMB-564

User Manual

Copyright Notice

The material in this document is the intellectual property of Advantech Co, LTD. We take every care in the preparation of this document, but no guarantee is given as to the correctness of its contents. Our products are under continual improvement and we reserve the right to make changes without notice.

Trademarks

Products and corporate names appearing in this manual may or may not be registered trademarks or copyrights of their respective companies, and are used only for identification or explanation and to the owners' benefit, without intent to infringe.

Part No. 2002056401 2nd. Edition
Printed in Taiwan January 2008

Notices

Federal Communications Commission Statement

This device complies with Part 15 of the FCC Rules. Operation is subject to the following two conditions:

- This device may not cause harmful interference, and
- This device must accept any interference received including interference that may cause undesired operation.

This equipment has been tested and found to comply with the limits for a Class B digital device, pursuant to Part 15 of the FCC Rules. These limits are designed to provide reasonable protection against harmful interference in a residential installation. This equipment generates, uses and can radiate radio frequency energy and, if not installed and used in accordance with manufacturer's instructions, may cause harmful interference to radio communications. However, there is no guarantee that interference will not occur in a particular installation. If this equipment does cause harmful interference to radio or television reception, which can be determined by turning the equipment off and on, the user is encouraged to try to correct the interference by one or more of the following measures:

- Reorient or relocate the receiving antenna.
- Increase the separation between the equipment and receiver.
- Connect the equipment to an outlet on a circuit different from that to which the receiver is connected.
- Consult the dealer or an experienced radio/TV technician for help.

Warning! *The use of shielded cables for connection of the monitor to the graphics card is required to assure compliance with FCC regulations. Changes or modifications to this unit not expressly approved by the party responsible for compliance could void the user's authority to operate this equipment.*



Canadian Department of Communications Statement

This digital apparatus does not exceed the Class B limits for radio noise emissions from digital apparatus set out in the Radio Interference Regulations of the Canadian Department of Communications.

This class B digital apparatus complies with Canadian ICES-003.

Safety Information

Electrical safety

- To prevent electrical shock hazard, disconnect the power cable from the electrical outlet before relocating the system.
- When adding or removing devices to or from the system, ensure that the power cables for the devices are unplugged before the signal cables are connected. If possible, disconnect all power cables from the existing system before you add a device.
- Before connecting or removing signal cables from the motherboard, ensure that all power cables are unplugged.
- Seek professional assistance before using an adapter or extension cord. These devices could interrupt the grounding circuit.
- Make sure that your power supply is set to the correct voltage in your area. If you are not sure about the voltage of the electrical outlet you are using, contact your local power company.
- If the power supply is broken, do not try to fix it by yourself. Contact a qualified service technician or your retailer.

Operation safety

- Before installing the motherboard and adding devices on it, carefully read all the manuals that came with the package.
- Before using the product, make sure all cables are correctly connected and the power cables are not damaged. If you detect any damage, contact your dealer immediately.
- To avoid short circuits, keep paper clips, screws, and staples away from connectors, slots, sockets and circuitry.
- Avoid dust, humidity, and temperature extremes. Do not place the product in any area where it may become wet.
- Place the product on a stable surface.
- If you encounter technical problems with the product, contact a qualified service technician or your retailer.

About this Guide

This user guide contains the information you need when installing and configuring the motherboard.

How this guide is organized

This manual contains the following parts:

- **Chapter 1: Product introduction**

This chapter describes the features of the motherboard and the new technology it supports. It also lists the hardware setup procedures that you have to perform when installing system components. It includes description of the jumpers and connectors on the motherboard.

- **Chapter 2: BIOS setup**

This chapter tells how to change system settings through the BIOS Setup menus. Detailed descriptions of the BIOS parameters are also provided.

- **Chapter 3: Software support**

This chapter describes the contents of the support CD that comes with the motherboard package.

Where to find more information

Refer to the following sources for additional information and for product and software updates.

1. Advantech websites

For more information on this and other Advantech products, please visit our website at:

<http://www.advantech.com>

For technical support and service, please visit our support website at:

<http://www.advantech.com.tw/support/>

2. Optional documentation

Your product package may include optional documentation, such as warranty flyers, that may have been added by your dealer. These documents are not part of the standard package.

Typography

Bold text	Indicates a menu or an item to select.
<i>Italics</i>	Used to emphasize a word or a phrase.
<Key>	Keys enclosed in the less-than and greater-than sign means that you must press the enclosed key. Example: <Enter> means that you must press the Enter or Return key.
<Key1>+<Key2>+<Key3>	If you must press two or more keys simultaneously, the key names are linked with a plus sign (+). Example: <Ctrl+Alt+D>
Command	Means that you must type the command exactly as shown, then supply the required item or value enclosed in brackets. Example: At the DOS prompt, type the command line: afudos /[filename]

AIMB-564 Specifications Summary

CPU	LGA775 socket for Intel® Quad-core / Core™ 2 Extreme/ Core™ 2 Duo / Pentium® D / Pentium® 4 / Celeron® D processor Compatible with Intel® 05B/05A/06 processors Intel® Hyper-Threading Technology ready
Chipset	Intel® Q965 / ICH8DO with Intel® Active Management Technology
System Bus	1066 / 800 / 533 MHz
Memory	4 x DIMM, max. 8GB, DDR2 800 / 667 / 533 MHz, non-ECC, un-buffered memory Dual channel memory architecture
Expansion Slots	1 x PCI-E x16 slot 1 x PCI-E x4 slot 2 x PCI slots
VGA	Intel® Graphics Media Accelerator 3000 (Intel® GMA 3000) integrated High Definition Video Processing with Max resolution to 2048 x 1536 bpp (@75Hz) Max. shared memory of 256MB Support Microsoft® DX 9, OpenGL 1.4, Pixel Shader 2.0
Storage	Southbridge - 6 x SATA 3.0 Gb/s ports - Intel® Matrix Storage Technology supports RAID 0, 1, 5, and 10 JMicron® JMB363 PATA and SATA controller - 1 x UltraDMA 133/100/66/33 for up to 2 PATA devices - 1 x Internal SATA 3.0 Gb/s port - 1 x External SATA 3.0 Gb/s port (SATA On-the-Go)
LAN	Intel® 82566DM PCI-E Gigabit Ethernet Controller
Audio	ADI® AD 1988 8-channel High Definition Audio CODEC - Support Jack-Sensing, Enumeration, Multi-streaming and Jack-Retasking - S/PDIF_OUT interface
IEEE 1394	TI®1394a controller supports 2 x IEEE 1394a ports (one at midboard; one at back panel)
USB	10 x USB 2.0 ports (6 ports at mid-board, 4 ports at back panel)

Back Panel I/O Ports	1 x PS/2 keyboard port 1 x PS/2 mouse port 1 x Parallel port 1 x External Serial ATA port 1 x VGA port 1 x IEEE 1394a connector 1 x RJ45 port 4 x USB 2.0/1.1 ports 8-channel Audio I/O ports
Internal Connectors	3 x USB 2.0 connectors support additional 6 USB ports 1 x Floppy disk drive connector 1 x IDE connector for two devices 1 x COM connector 1 x TPM connector 7 x Serial ATA connectors 1 x CPU Fan connector 2 x Chassis Fan connectors 1 x Power Fan connector 1 x IEEE1394a connector Front panel audio connector 1 x Azalia Digital Header 1 x S/PDIF Out Header Chassis intrusion connector CD audio in 24-pin ATX Power connector 1 x 4-pin ATX 12 V Power connector System panel connector
BIOS Features	16 Mb Flash ROM, AMI BIOS, PnP, DMI 2.0, WfM2.0, SM BIOS 2.3, ACPI 2.0a
Manageability	WfM 2.0, DMI 2.0, WOL by PME, WOR by PME, PXE, RPL
Support CD Contents	Drivers Advantech manual
Form Factor	uATX form factor: 9.6" x 9.6" (24.4 cm x 24.4 cm)

*Specifications are subject to change without notice.

Contents

Chapter 1	Product Information	2
1.1	Welcome!	2
1.2	Package Contents	2
	Table 1.1 Package Contents.....	2
1.3	Before you Proceed	3
1.3.1	Onboard LED.....	4
	Figure 1.1 Onboard LED	4
1.4	Motherboard Overview	5
1.4.1	Placement Direction.....	5
1.4.2	Screw Holes.....	5
	Figure 1.2 Screw holes.....	5
1.4.3	Motherboard Layout	6
	Figure 1.3 Motherboard layout	6
1.4.4	Layout Contents.....	7
1.5	Central Processing Unit (CPU).....	9
1.5.1	Installing the CPU.....	10
	Figure 1.4 AIMB-564 CPU socket 775	10
1.5.2	Installing the CPU Heatsink and Fan.....	13
	Figure 1.5 AIMB-564 CPU Fan Connector	15
1.5.3	Uninstalling the CPU Heatsink and Fan.....	16
1.6	System Memory	19
1.6.1	Overview.....	19
	Figure 1.6 240-pin DDR2 DIMM socket.....	19
1.6.2	Memory Configuration	20
1.6.3	Installing a DIMM.....	21
1.6.4	Removing a DIMM.....	22
1.7	Expansion Slots.....	23
1.7.1	Installing an Expansion Card.....	23
1.7.2	Configuring an Expansion Card	23
1.7.3	Interrupt Assignments.....	24
	Table 1.2 Standard Interrupt Assignments	24
	Table 1.3 IRQ Assignments for AIMB-564	24
1.7.4	PCI Slots	26
1.7.5	PCI Express x4 Slot	26
1.7.6	PCI Express x16 Slot	27
1.8	Jumper	28
1.8.1	Clear RTC RAM (CLRTC)	28
	Figure 1.7 Clear RTC RAM.....	29
1.8.2	Keyboard Power (3-pin KBPWR)	30
	Figure 1.8 Keyboard Power Setting.....	30
1.9	Connectors.....	31

1.9.1	Rear Panel Connectors.....	31
Table 1.4	Activity/Link Speed LED.....	31
Table 1.5	Audio 2, 4, 6, or 8-Channel Config.....	32
1.9.2	Internal Connectors.....	34
Figure 1.9	Floppy Disk Drive Connector.....	34
Figure 1.10	SPDIF OUT connector.....	34
Figure 1.11	AIMB-564 IDE connector.....	35
Figure 1.12	SATA connectors.....	36
Figure 1.13	IEEE 1394a Connector.....	37
Figure 1.14	SATA RAID connector.....	38
Figure 1.15	TPM connector.....	39
Figure 1.16	USB 2.0 connectors.....	40
Figure 1.17	Internal Audio Connector.....	41
Figure 1.18	Fan connectors.....	41
Figure 1.19	Serial port connector.....	42
Figure 1.20	Chassis Intrusion connector.....	42
Figure 1.21	Front panel audio connector.....	43
Figure 1.22	ATX Power connector.....	44
Chapter 2	Award BIOS Setup.....	48
2.1	Introduction.....	48
2.1.1	BIOS Setup Program.....	48
2.1.2	CMOS RAM Auto-backup and Restore.....	49
2.2	Entering Setup.....	50
Figure 2.1	Award BIOS Setup initial screen.....	50
2.3	Standard CMOS Setup.....	51
Figure 2.2	Standard CMOS Features Screen.....	51
2.3.1	Date.....	51
2.3.2	Time.....	52
2.3.3	IDE Channel 0/1 Master/Slave.....	52
2.3.4	Drive A / Drive B.....	52
2.3.5	Video.....	52
2.3.6	Halt On.....	53
2.3.7	Memory.....	53
2.4	Advanced BIOS Features.....	53
Figure 2.3	Advanced BIOS Features screen.....	53
2.4.1	CPU Features.....	54
2.4.2	Hard Disk Boot Priority.....	54
2.4.3	Virus Warning.....	54
2.4.4	CPU L1, L2 & L3 Cache.....	54
2.4.5	Quick Power On Self Test.....	54
2.4.6	First/Second/Third Boot Device.....	54
2.4.7	Boot Other Device.....	54
2.4.8	Swap Floppy Drive.....	55
2.4.9	Boot Up Floppy Seek.....	55
2.4.10	Boot Up NumLock Status.....	55

2.4.11	Gate A20 Option.....	55
2.4.12	Typematic Rate Setting.....	55
2.4.13	Typematic Rate (Chars/Sec).....	55
2.4.14	Typematic Delay (msec).....	55
2.4.15	Security Option.....	55
2.4.17	MPS Version Control For OS.....	56
2.4.18	OS Select For DRAM > 64MB.....	56
2.5	Advanced Chipset Features.....	57
	Figure 2.4 Advanced Chipset Features screen.....	57
2.5.1	Memory Hole At 15M-16M.....	57
2.5.2	Configure AMT BIOS Support (Intel® Active Management Technology).....	58
2.5.3	PEG / Onchip VGA Control.....	58
2.5.4	On-Chip Frame Buffer Size.....	58
2.5.5	DVMT Mode.....	58
2.5.6	DVMT / FIXED Memory Size.....	58
2.6	Integrated Peripherals.....	59
	Figure 2.5 Integrated peripherals.....	59
	Figure 2.6 On-Chip IDE Device.....	59
2.6.1	On board Lan Boot ROM:.....	59
2.6.2	IDE HDD Block Mode.....	60
2.6.3	IDE DMA Transfer Access.....	60
2.6.4	On-Chip Primary / Secondary IDE Device.....	60
2.6.5	SATA Mode.....	60
2.6.6	Legacy Mode Support.....	60
	Figure 2.7 USB device setting.....	61
2.6.7	USB 1.0 Controller.....	61
2.6.8	USB Operation Mode.....	61
2.6.9	USB Storage Function:.....	61
2.6.10	USB 2.0 Controller.....	61
2.6.11	USB Keyboard / Mouse Support.....	62
2.6.12	HD Audio Codec.....	62
	Figure 2.9 Super I/O Device.....	63
2.6.13	Onboard FDC Controller.....	63
2.6.14	Onboard Serial Port 1.....	63
2.6.15	Onboard Serial Port 2.....	63
2.6.16	Onboard Parallel Port.....	63
2.6.17	Parallel Port Mode.....	64
2.6.18	EPP Mode Select.....	64
2.6.19	ECP Mode Use DMA.....	64
2.6.20	PWRON After PWR-Fail.....	64
2.7	Power Management Setup.....	65
	Figure 2.10 Power management setup screen.....	65
2.7.1	ACPI Function.....	65
2.7.2	ACPI Suspend Type.....	65

2.7.3	Run VGA BIOS if S3 Resume	65
2.7.4	Power Management	66
	Table 2.1 Power Saving.....	66
2.7.5	Video Off Method.....	66
2.7.6	Video Off In Suspend	66
2.7.7	Suspend Type.....	66
2.7.8	Suspend Mode.....	66
2.7.9	HDD Power Down.....	66
2.7.10	Soft-Off by PWR-BTTN	67
2.7.11	PowerOn by Modem or Power On by Ring.....	67
2.7.12	USB KB Wake Up From S3	67
2.7.13	PowerOn by Alarm or Resume by Alarm.....	67
2.7.14	Wake-Up by PCI card.....	67
2.7.15	FDD, COM, LPT PORT	67
2.7.16	PCI PIRQ [A-D]#	67
2.8	PnP/PCI Configuration.....	68
	Figure 2.11 PnP/PCI configurations screen	68
2.8.1	Init Display First	68
2.8.2	Reset Configuration Data.....	68
2.8.3	Resources Controlled By	68
2.8.4	PCI / VGA Palette Snoop	68
2.8.5	Maximum Payload Size	68
2.9	PC Health Status.....	69
	Figure 2.12 PC Health Status Screen	69
2.9.1	System Temperature	69
2.9.2	CPU FAN Speed	69
2.9.3	System FAN Speed.....	69
2.9.4	VCORE and Other Voltages.....	69
	Figure 2.13 Spread Spectrum Frequency/Voltage Control screen	70
2.10.1	CPU Clock Ratio Unlock.....	70
2.10.2	CPU Clock Ratio	70
2.10.3	Spread Spectrum	70
2.11	TPM Support.....	71
	Figure 2.14 Security Chip Configuration.....	71
2.11.1	TPM Support [Disabled].....	71
2.11.2	TPM Status [No Change].....	71
	Figure 2.15 Security Chip Configuration.....	72
	Figure 2.16 TPM POST Screen	72
2.12	Password Setting	73
2.13	Save & Exit Setup	74
2.14	Exit Without Saving.....	75

Product Introduction

This chapter describes the motherboard features and the new technologies it supports.

Chapter 1 Product Information

1.1 Welcome!

Thank you for buying an Advantech AIMB-564 motherboard!

The motherboard delivers a host of new features and latest technologies, making it another standout in the long line of Advantech motherboards!

Before you start installing the motherboard, and hardware devices on it, check the items in your package with the list below.

1.2 Package Contents

Check your motherboard package for the following items.

Table 1.1: Package Contents

Motherboard	Advantech AIMB-564
Cables	1 x Com cable 1 x Ultra DMA 133/100/66 cable 1 x Floppy disk drive cable I/O shield 4 x SATA data cables 2 x SATA power cables
Application CD	Advantech Driver CD
Documentation	Startup manual

If any of the above items is damaged or missing, contact your retailer.

1.3 Before you Proceed

Take note of the following precautions before you install motherboard components or change any motherboard settings.

Caution!



1. *Unplug the power cord from the wall socket before touching any component.*
2. *Use a grounded wrist strap or touch a safely grounded object or a metal object, such as the power supply case, before handling components to avoid damaging them due to static electricity.*
3. *Hold components by the edges to avoid touching the ICs on them.*
4. *Whenever you uninstall any component, place it on a grounded antistatic pad or in the bag that came with the component.*
5. *Before you install or remove any component, ensure that the ATX power supply is switched off or the power cord is detached from the power supply. Failure to do so may cause severe damage to the motherboard, peripherals, and/or components.*

1.3.1 Onboard LED

The motherboard comes with a standby power LED that lights up to indicate that the system is ON, in sleep mode, or in soft-off mode. This is a reminder that you should shut down the system and unplug the power cable before removing or plugging in any motherboard component. The illustration below shows the location of the onboard LED.

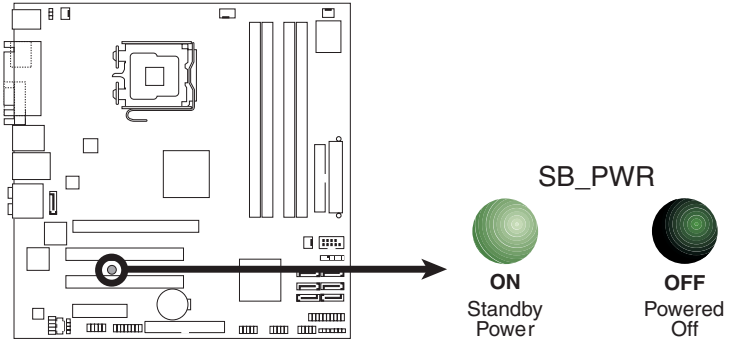

Figure 1.1: Onboard LED

1.4 Motherboard Overview

Before you install the motherboard, study the configuration of your chassis to ensure that the motherboard fits into it.

Warning! *Make sure to unplug the power cord before installing or removing the motherboard. Failure to do so can cause you physical injury and damage motherboard components.*



1.4.1 Placement Direction

When installing the motherboard, make sure that you place it into the chassis in the correct orientation. The edge with external ports goes to the rear part of the chassis as indicated in the image below.

1.4.2 Screw Holes

Place eight screws into the holes indicated by circles to secure the motherboard to the chassis.

Caution! *Do not overtighten the screws! Doing so can damage the motherboard.*

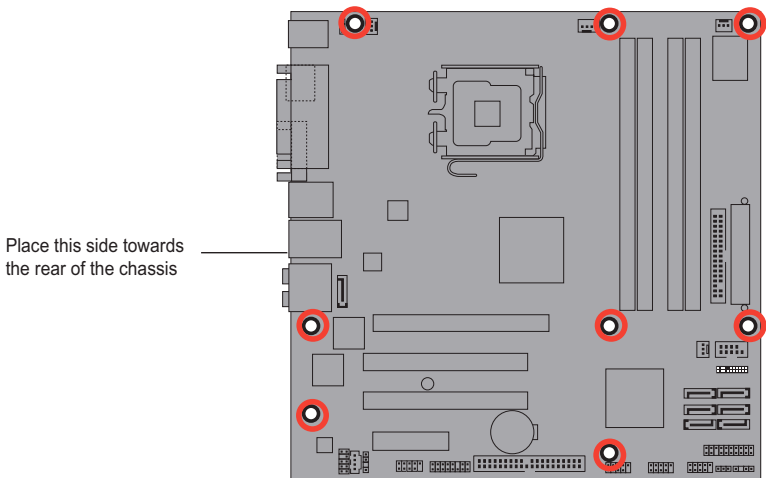

Figure 1.2: Screw holes

1.4.3 Motherboard Layout

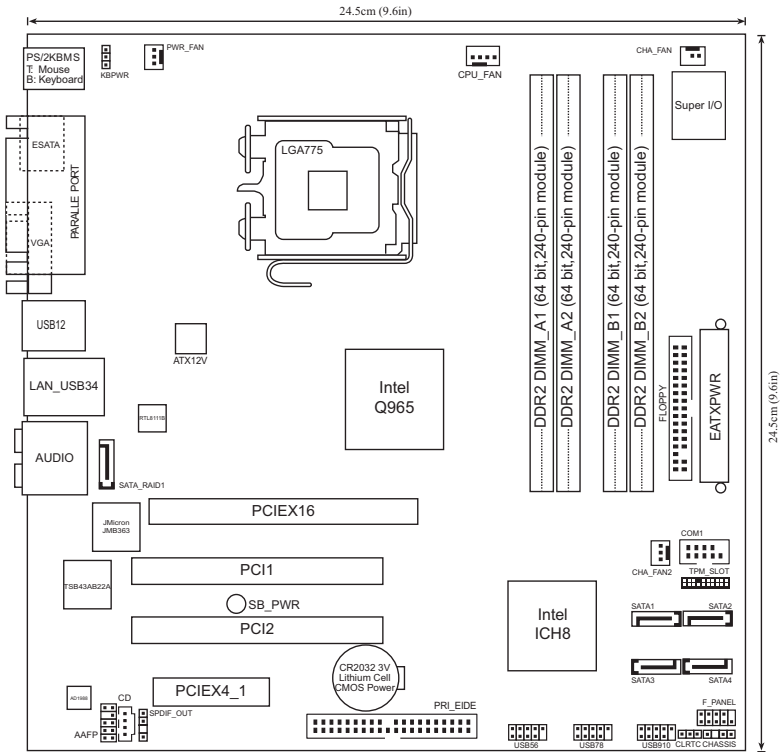

Figure 1.3: Motherboard layout

Note: Refer to 1.9 **Connectors** for more information about rear panel connectors and internal connectors.

1.4.4 Layout Contents

Slots		Page
1.	DDR2 DIMM slots	1-19
2.	PCI slots	1-25
3.	PCI Express x 4 slot	1-25
4.	PCI Express x16 slot	1-26

Jumper		Page
1.	Clear RTC RAM (3-pin CLRTC)	1-27
2.	Keyboard power (3-pin KBPWR)	1-28

Rear panel connectors		Page
1.	PS/2 mouse port (green)	1-29
2.	Parallel port	1-29
3.	IEEE 1394a port	1-29
4.	LAN (RJ-45) port	1-29
5.	Rear Speaker Out port (black)	1-30
6.	Center/Subwoofer port (orange)	1-30
7.	Line In port (light blue)	1-30
8.	Line Out port (lime)	1-30
9.	Microphone port (pink)	1-30
10.	Side Speaker Out port (gray)	1-30
11.	USB 2.0 ports 1 and 2	1-31
12.	USB 2.0 ports 3 and 4	1-31
13.	VGA port	1-31
14.	External SATA port	1-31
15.	PS/2 keyboard port (purple)	1-31

Internal connectors		Page
1.	Floppy disk drive connector (34-1 pin FLOPPY)	1-32
2.	Digital Audio connector (4-1 pin SPDIF_OUT)	1-32
3.	IDE connector (40-1 pin PRI_IDE)	1-33
4.	ICH8DO Serial ATA connectors (7-pin SATA1 [red], SATA2 [red], SATA3 [red], SATA4 [red], SATA5 [black], SATA6 [black])	1-34
5.	IEEE 1394a port connector (10-1 pin IE1394_2)	1-35
6.	JMicron® JMB363 Serial ATA RAID connector (7-pin SATA_RAID1)	1-36
7.	TPM connector (20-1 pin TPM_SLOT)	1-37
8.	USB connectors (10-1 pin USB56, USB 78, USB910)	1-38
9.	Optical drive audio connector (4-pin CD)	1-39
10.	CPU, chassis, and power fan connectors (4-pin CPU_FAN, 3-pin CHA_FAN, 3-pin CHA_FAN2, 3-pin PWR_FAN)	1-39
11.	Serial port connector (10-1 pin COM1)	1-40
12.	Chassis intrusion connector (4-1 pin CHASSIS)	1-40
13.	Front panel audio connector (10-1 pin AAFP)	1-41
14.	ATX power connectors (24-pin EATXPWR, 4-pin EATX12V)	1-42

1.5 Central Processing Unit (CPU)

The motherboard comes with a surface mount LGA775 socket designed for the Intel® Core™2 Extreme/Core™2 Duo/Pentium® D/Pentium® 4 and Celeron® D processors.

- Note:**
1. Make sure the AC power is off before you install the CPU.
 2. If installing a dual-core CPU, connect the chassis fan cable to the CHA_FAN connector to ensure system stability.

Caution!



1. Upon purchase of the motherboard, make sure that the PnP cap is on the socket and the socket contacts are not bent. Contact your retailer immediately if the PnP cap is missing, or if you see any damage to the PnP cap/socket contacts/motherboard components. We will bear the cost of repair only if the damage is shipment/transit-related.
2. Keep the cap after installing the motherboard. We will process Return Merchandise Authorization (RMA) requests only if the motherboard comes with the cap on the LGA775 socket.
3. The product warranty does not cover damage to the socket contacts resulting from incorrect CPU installation/removal, or misplacement/loss/incorrect removal of the PnP cap.

1.5.1 Installing the CPU

To install a CPU:

1. Locate the CPU socket on the motherboard.

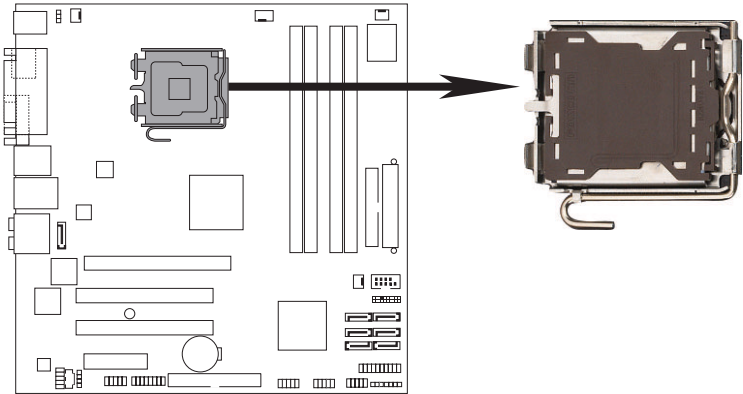
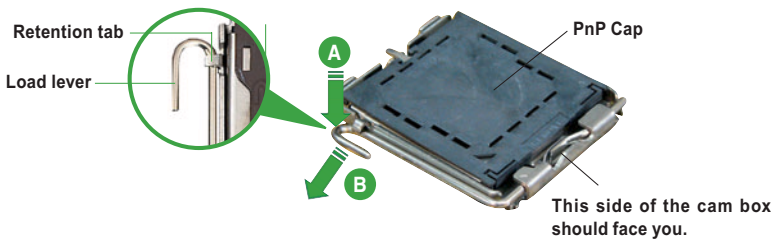

Figure 1.4: AIMB-564 CPU socket 775

Note: Before installing the CPU, make sure that the cam box is facing towards you and the load lever is on your left.

2. Press the load lever with your thumb (A), then move it to the left (B) until it is released from the retention tab.



Note: To prevent damage to the socket pins, do not remove the PnP cap unless you are installing a CPU.

3. Lift the load lever in the direction of the arrow to a 135° angle.

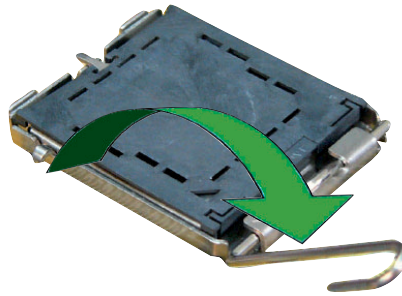

4. Lift the load plate with your thumb and forefinger to a 100° angle (A), then push the PnP cap from the load plate window to remove (B).

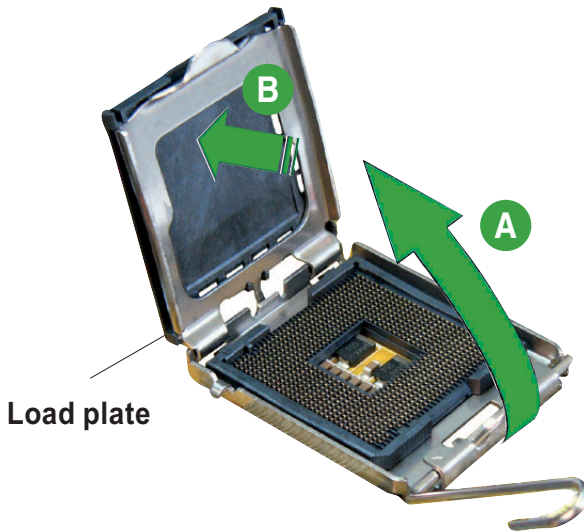

5. Position the CPU over the socket, making sure that the gold triangle is on the bottom-left corner of the socket, then fit the socket alignment key into the CPU notch.

Alignment key

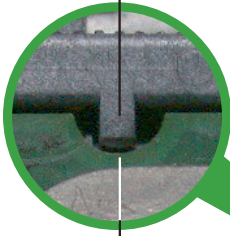

CPU notch

Gold triangle mark

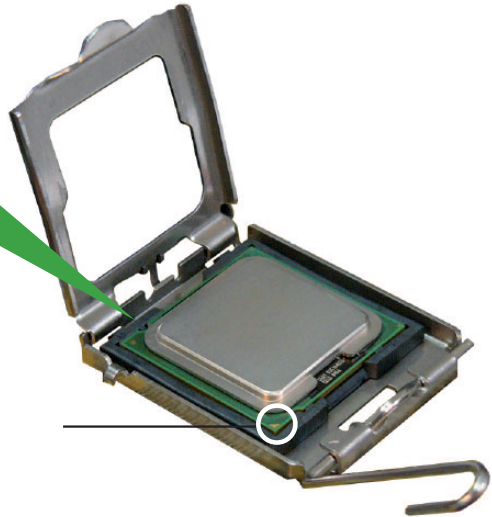

Note: *The CPU fits in only one correct orientation. DO NOT force the CPU into the socket to prevent bending the connectors on the socket and damaging the CPU!*

6. Close the load plate (A), then push the load lever (B) until it snaps into the retention tab.

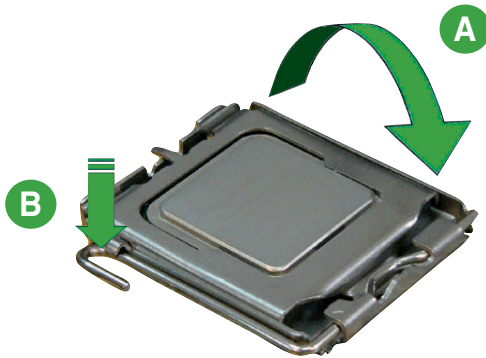

7. If installing a dual-core CPU, connect the chassis fan cable to the CHA_FAN1 connector to ensure system stability.

Note: *The motherboard supports Intel® LGA775 processors with Intel® Enhanced Memory 64 Technology (EM64T), Enhanced Intel SpeedStep® Technology (EIST), and Hyper-Threading Technology.*

1.5.2 Installing the CPU Heatsink and Fan

The Intel® LGA775 processor requires a specially designed heatsink and fan assembly to ensure optimum thermal condition and performance.

- Note:**
1. *When you buy a boxed Intel® processor, the package includes the CPU fan and heatsink assembly. If you buy a CPU separately, make sure that you use only an Intel®-certified multi-directional heatsink and fan.*
 2. *Your Intel® LGA775 heatsink and fan assembly comes in a push-pin design and requires no tools to install.*
 3. *If you purchased a separate CPU heatsink and fan assembly, make sure that you have properly applied Thermal Interface Material to the CPU heatsink or CPU before you install the heatsink and fan assembly.*

Note: *Make sure that you have installed the motherboard to the chassis before you install the CPU fan and heatsink assembly.*

To install the CPU heatsink and fan:

1. Place the heatsink on top of the installed CPU, making sure that the four fasteners match the holes on the motherboard.

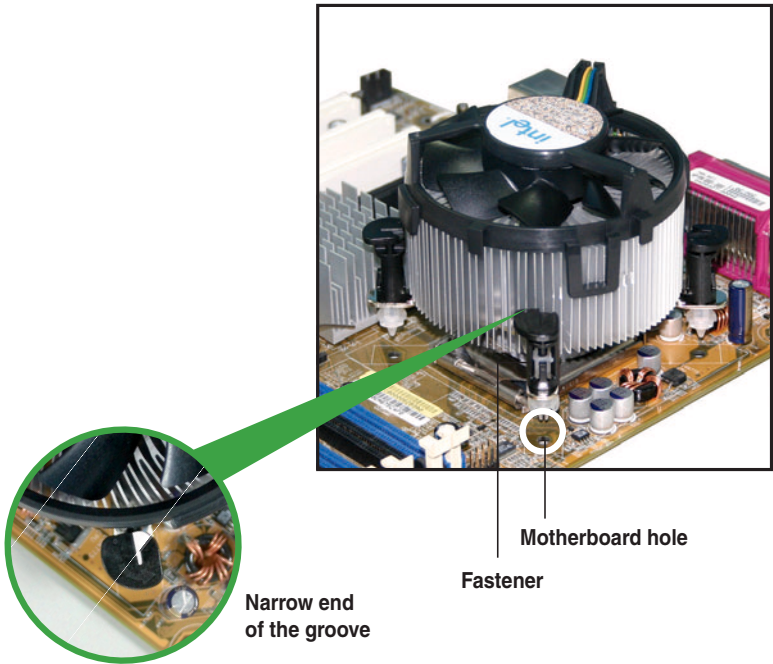

Note: Orient the heatsink and fan assembly such that the CPU fan cable is closest to the CPU fan connector. Make sure to orient each fastener with the narrow end of the groove pointing outward. (The photo shows the groove shaded for emphasis.)

2. Push down two fasteners at a time in a diagonal sequence to secure the heatsink and fan assembly in place.

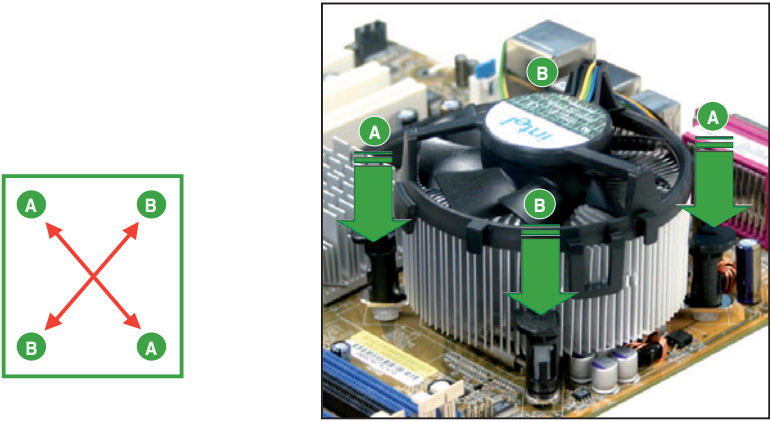

3. Connect the CPU fan cable to the connector on the motherboard labeled CPU_FAN.

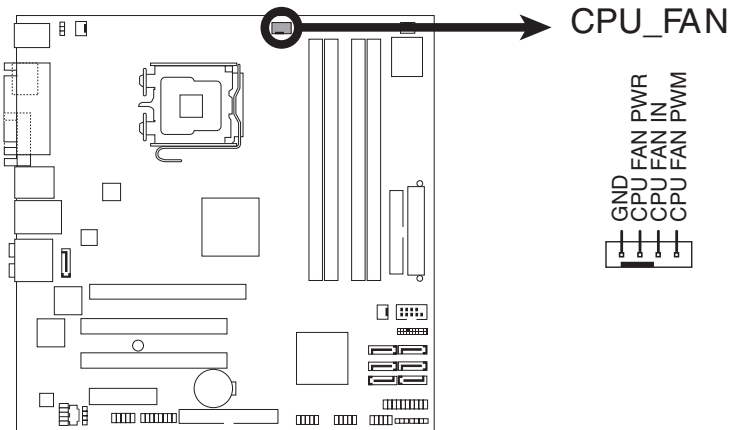

Figure 1.5: AIMB-564 CPU Fan Connector

Note: Do not forget to connect the CPU fan connector! Hardware monitoring errors can occur if you fail to plug in this connector.

1.5.3 Uninstalling the CPU Heatsink and Fan

To uninstall the CPU heatsink and fan:

1. Disconnect the CPU fan cable from the connector on the motherboard.
2. Rotate each fastener counterclockwise.



3. Pull up two fasteners at a time in a diagonal sequence to disengage the heatsink and fan assembly from the motherboard.

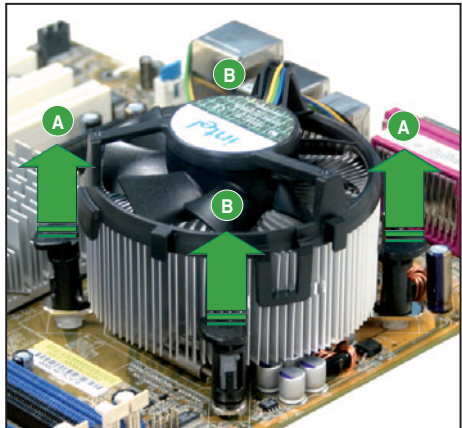
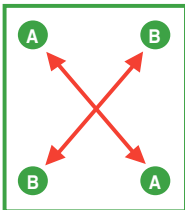

- Carefully remove the heatsink and fan assembly from the motherboard.

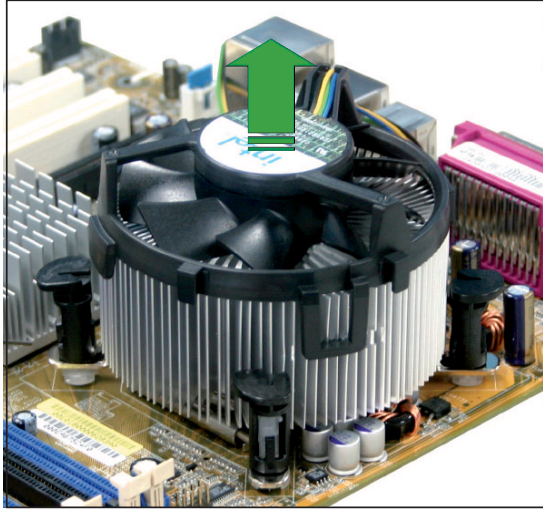

- Rotate each fastener clockwise to ensure correct orientation when reinstalling.

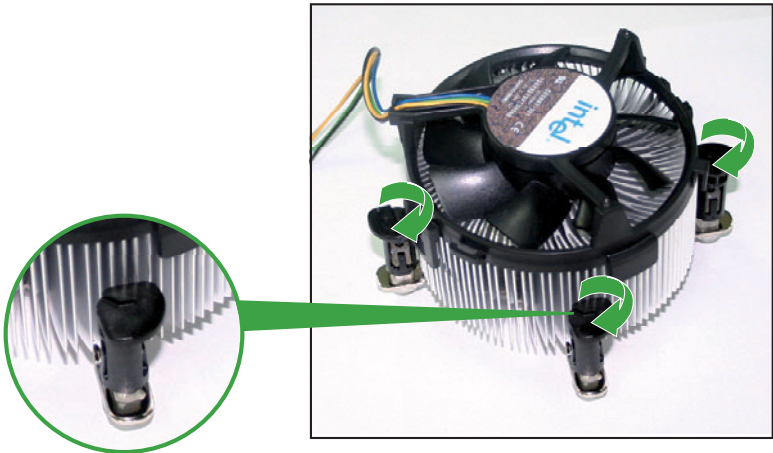

Note: *The narrow end of the groove should point outward after resetting. (The photo shows the groove shaded for emphasis.)*

Narrow end of the groove

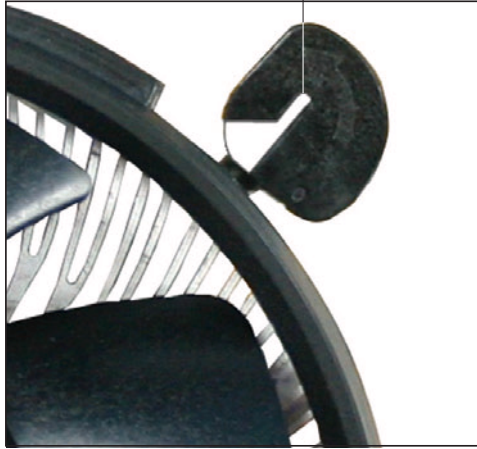

Note: Refer to the documentation in the boxed or stand-alone CPU fan package for detailed information on CPU fan installation.

1.6 System Memory

1.6.1 Overview

The motherboard comes with four Double Data Rate 2 (DDR2) Dual Inline Memory Modules (DIMM) sockets.

A DDR2 module has the same physical dimensions as a DDR DIMM but has a 240-pin footprint compared to the 184-pin DDR DIMM. DDR2 DIMMs are notched differently to prevent installation on a DDR DIMM socket.

The figure illustrates the location of the DDR2 DIMM sockets:

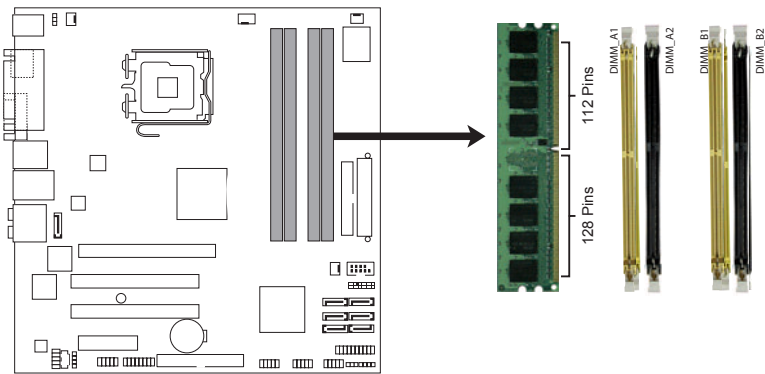

Figure 1.6: 240-pin DDR2 DIMM socket

Channel	Sockets
Channel A	DIMM_A1 and DIMM_A2
Channel B	DIMM_B1 and DIMM_B2

Note: *Install at least one memory module in DIMM_A1 or DIMM_A2 slot to support the Intel® Quiet System Technology and for optimum performance. Otherwise, the system will halt.*

1.6.2 Memory Configuration

You may install 256 MB, 512 MB, 1 GB, and 2 GB unbuffered non-ECC DDR2 DIMMs into the DIMM sockets.

- Note:**
- 1. You may install varying memory sizes in Channel A and Channel B. The system maps the total size of the lower-sized channel for the dual-channel configuration. Any excess memory from the higher-sized channel is then mapped for single-channel operation.*
 - 2. Always install DIMMs with the same CAS latency. For optimum compatibility, it is recommended that you obtain memory modules from the same vendor.*
 - 3. If you install four 1GB memory modules or 2GB memory modules, the system may only recognize 3GB or less because the address space is reserved for other critical functions. This limitation appears on Windows® XP 32-bit operating systems which do not support Physical Address Extension (PAE).*
 - 4. If you install a Windows® XP 32-bit operating system, a total memory of less than 3GB is recommended.*
 - 5. This motherboard does not support memory modules made up of 128 Mb chips or double sided x16 memory modules.*

Note:*Notes on memory limitations:*

1. *Due to chipset limitations, this motherboard can only support up to 8 GB on the operating systems listed below. You may install a maximum of 2 GB DIMMs on each slot, but only DDR2-533 and DDR2-667 2 GB density modules are available for this configuration.*
2. *Some old-version DDR2-800/667 DIMMs may not match Intel®'s On-Die-Termination (ODT) requirement and will automatically downgrade to run at DDR2-533. If this happens, contact your memory vendor to check the ODT value.*
3. *Due to chipset limitations, the DDR2-800 with CL=4 will be downgraded to run at DDR2-667 by default. If you want to operate with lower latency, adjust the memory timing manually.*
4. *Due to chipset limitations, the DDR2-667 with CL=3 will be downgraded to run at DDR2-533 by default. If you want to operate with lower latency, adjust the memory timing manually.*
5. *The total memory may have an 8MB reduction under Single Channel mode, and a 16MB reduction under Dual Channel mode because the address space is reserved for the Intel® vPro™ Technology and the Intel® Quiet System Technology.*

1.6.3 Installing a DIMM

Caution!

Unplug the power supply before adding or removing DIMMs or other system components. Failure to do so can cause severe damage to both the motherboard and the components.

To install a DIMM:

1. Unlock a DIMM socket by pressing the retaining clips outward.
2. Align a DIMM on the socket such that the notch on the DIMM matches the break on the socket.
3. Firmly insert the DIMM into the socket until the retaining clips snap back in place and the DIMM is properly seated.

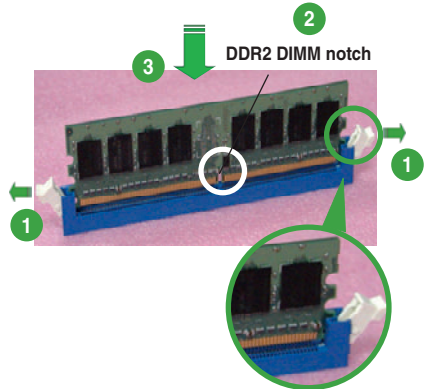

Note: A DDR2 DIMM is keyed with a notch so that it fits in only one direction. Do not force a DIMM into a socket to avoid damaging the DIMM.

The DDR2 DIMM sockets do not support DDR DIMMs. Do not install DDR DIMMs to the DDR2 DIMM sockets.

1.6.4 Removing a DIMM

To remove a DIMM:

1. Simultaneously press the retaining clips outward to unlock the DIMM.

Note: Support the DIMM lightly with your fingers when pressing the retaining clips. The DIMM might get damaged if it flips out with extra force.

2. Remove the DIMM from the socket.

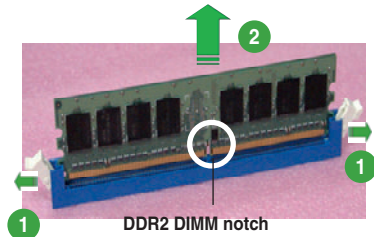

1.7 Expansion Slots

In the future, you may need to install expansion cards. The following subsections describe the slots and the expansion cards that they support.

Warning! *Make sure to unplug the power cord before adding or removing expansion cards. Failure to do so may cause you physical injury and damage motherboard components.*



1.7.1 Installing an Expansion Card

To install an expansion card:

1. Before installing the expansion card, read the documentation that came with it and make the necessary hardware settings for the card.
2. Remove the system unit cover (if your motherboard is already installed in a chassis).
3. Remove the bracket opposite the slot that you intend to use. Keep the screw for later use.
4. Align the card connector with the slot and press firmly until the card is completely seated on the slot.
5. Secure the card to the chassis with the screw you removed earlier.
6. Replace the system cover.

1.7.2 Configuring an Expansion Card

After installing the expansion card, configure it by adjusting the software settings.

1. Turn on the system and change the necessary BIOS settings, if any. See Chapter 2 for information on BIOS setup.
2. Assign an IRQ to the card. Refer to the tables on the next page.
3. Install the software drivers for the expansion card.

Note: *When using PCI cards on shared slots, ensure that the drivers support “Share IRQ” or that the cards do not need IRQ assignments. Otherwise, conflicts will arise between the two PCI groups, making the system unstable and the card inoperable. Refer to the table on the next page for details.*

1.7.3 Interrupt Assignments

Table 1.2: Standard Interrupt Assignments

IRQ	Priority	Standard function
0	1	System Timer
1	2	Keyboard Controller
2	-	Redirect to IRQ#9
3	11	IRQ holder for PCI steering*
4	12	Communications Port (COM1)*
5	13	IRQ holder for PCI steering*
6	14	Floppy Disk Controller
7	15	Printer Port (LPT1)*
8	3	System CMOS/Real Time Clock
9	4	IRQ holder for PCI steering*
10	5	IRQ holder for PCI steering*
11	6	IRQ holder for PCI steering*
12	7	PS/2 Compatible Mouse Port*
13	8	Numeric Data Processor
14	9	Primary IDE Channel
15	10	Secondary IDE Channel

* These IRQs are usually available for ISA or PCI devices.

IRQ assignments for this motherboard

Table 1.3: IRQ Assignments for AIMB-564

	A	B	C	D	E	F	G	H
PCI Slot 1	share d	-	-	-	-	-	-	-
PCI Slot 2	-	shared	-	-	-	-	-	-
PCIe x 16_1	share d	shared	-	-	-	-	-	-
PCIe x 4_1	share d	shared	-	-	-	-	-	-
Onboard ESATA, SATA_RAID	share d	-	-	-	-	share d	-	-
Onboard PRI_IDE	share d	-	-	-	-	-	-	-

Table 1.3: IRQ Assignments for AIMB-564

Onboard HD Audio (AD1988)	-	-	-	-	-	-	-	share d	-
Onboard GbEthernet (82566DM)	-	shared	-	-	-	-	-	-	-
USB 2.0 EHCI#1	-	-	-	-	-	-	-	share d	-
USB 2.0 EHCI#2	-	-	-	-	-	-	-	share d	-
USB12 UHCI#1	-	-	-	-	-	-	-	share d	-
USB34 UHCI#2	-	-	-	share d	-	-	-	-	-
USB56 UHCI#3	-	-	share d	-	-	-	-	-	-
USB78 UHCI#4	share d	-	-	-	-	-	-	-	-
USB910 UHCI#5	share d	-	-	-	-	-	-	-	-
SATA1/2/5/6 (ICH8DO)	-	-	share d	-	-	-	-	-	-
SATA3/4 (ICH8DO)	-	-	-	share d	-	-	-	-	-
IDE-R controller	-	-	share d	-	-	-	-	-	-
KT controller	-	shared	-	-	-	-	-	-	-

1.7.4 PCI Slots

The PCI slots support cards such as a LAN card, SCSI card, USB card, and other cards that comply with PCI specifications. The figure shows a LAN card installed on a PCI slot.

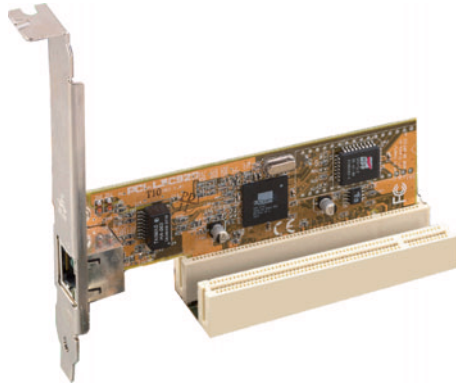

1.7.5 PCI Express x4 Slot

This motherboard supports PCI Express x4 network cards, SCSI cards and other cards that comply with the PCI Express specifications. The following figure shows a network card installed on the PCI Express x4 slot.



1.7.6 PCI Express x16 Slot

This motherboard supports PCI Express x16 graphic cards that comply with the PCI Express specifications. The figure shows a graphics card installed on the PCI Express x16 slot.

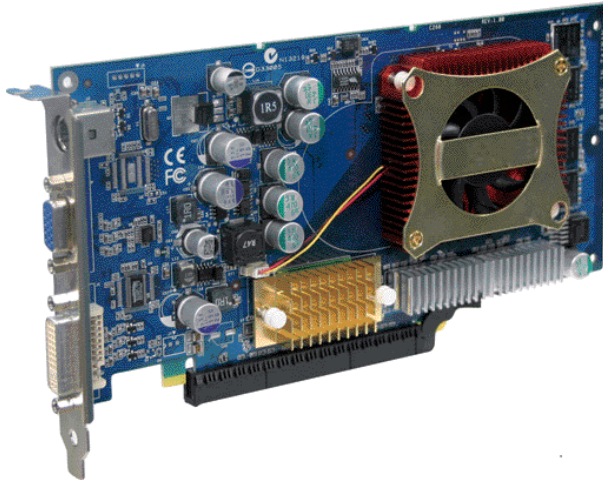

1.8 Jumper

1.8.1 Clear RTC RAM (CLRRTC)

This jumper allows you to clear the Real Time Clock (RTC) RAM in CMOS. You can clear the CMOS memory of date, time, and system setup parameters by erasing the CMOS RTC RAM data. The onboard button cell battery powers the RAM data in CMOS, which include system setup information such as system passwords.

To erase the RTC RAM:

1. Turn OFF the computer and unplug the power cord.
2. Remove the onboard battery.
3. Move the jumper cap from pins 1-2 (default) to pins 2-3. Keep the cap on pins 2-3 for about 5~10 seconds, then move the cap back to pins 1-2.
4. Reinstall the battery.
5. Plug the power cord and turn ON the computer.
6. Hold down the key during the boot process and enter BIOS setup to re-enter data.

Caution! *Except when clearing the RTC RAM, never remove the cap on CLRRTC jumper default position. Removing the cap will cause system boot failure!*

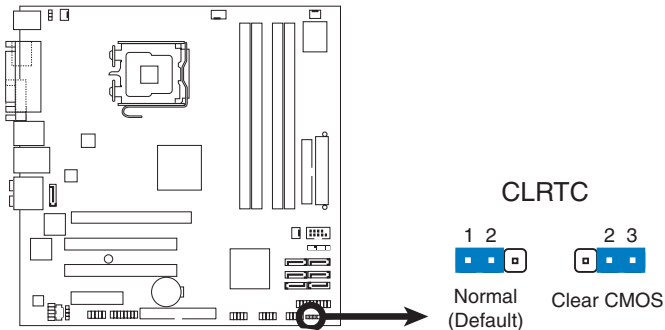

Figure 1.7: Clear RTC RAM

Note: You do not need to clear the RTC when the system hangs due to overclocking. For system failure due to overclocking, use the C.P.R. (CPU Parameter Recall) feature. Shut down and reboot the system so the BIOS can automatically reset parameter settings to default values.

Due to chipset limitations, AC power off is required prior to using the C.P.R. function. You must turn off and on the power supply or unplug and plug the power cord before rebooting the system.

1.8.2 Keyboard Power (3-pin KBPWR)

This jumper allows you to enable or disable the keyboard wake-up feature. Set this jumper to pins 2-3 (+5VSB) to wake up the computer when you press a key on the keyboard (the default is the Space Bar). This feature requires an ATX power supply that can supply at least 1A on the +5VSB lead, and a corresponding setting in the BIOS.

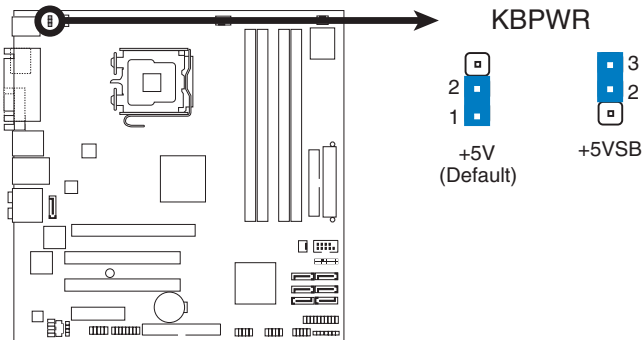
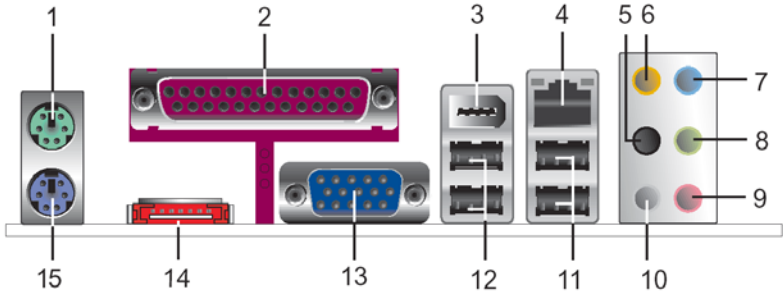

Figure 1.8: Keyboard Power Setting

1.9 Connectors

1.9.1 Rear Panel Connectors



1. **PS/2 mouse port (green).** This port is for a PS/2 mouse.
2. **Parallel port.** This 25-pin port connects a parallel printer, a scanner, or other devices.
3. **IEEE 1394a port.** This 6-pin IEEE 1394a port provides high-speed connectivity for audio/video devices, storage peripherals, PCs, or portable devices.
4. **LAN (RJ-45) port.** Supported by Realtek® Gigabit LAN controller, this port allows Gigabit connection to a Local Area Network (LAN) through a network hub. Refer to the table below for the LAN port LED indications.

LAN port LED indications

Table 1.4: Activity/Link Speed LED

Status	Description	Status	Description
OFF	No link	OFF	10 Mbps connection
ORANGE	Linked	ORANGE	100 Mbps connection
BLINKING	Data activity	GREEN	1 Gbps connection

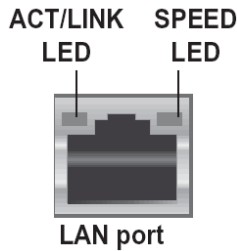

5. **Rear Speaker Out port (black).** This port connects the rear speakers in a 4-channel, 6-channel, or 8-channel audio configuration.
6. **Center/Subwoofer port (orange).** This port connects the center/subwoofer speakers.
7. **Line In port (light blue).** This port connects the tape, CD, DVD player, or other audio sources.
8. **Line Out port (lime).** This port connects a headphone or a speaker. In 4-channel, 6-channel, and 8-channel configuration, the function of this port becomes Front Speaker Out.
9. **Microphone port (pink).** This port connects a microphone.
10. **Side Speaker Out port (gray).** This port connects the side speakers in an 8-channel audio configuration.

Note: Refer to the audio configuration table below for the function of the audio ports in 2, 4, 6, or 8-channel configuration.

Audio 2, 4, 6, or 8-channel configuration

Table 1.5: Audio 2, 4, 6, or 8-Channel Config

Port	Headset 2-channel	4-channel	6-channel	8-channel
Light Blue	Line In	Line In	Line In	Line In
Lime	Line Out	Front Speaker Out	Front Speaker Out	Front Speaker Out
Pink	Mic In	Mic In	Mic In	Mic In
Orange	-	-	Center/Subwoofer	Center/Subwoofer
Black	-	Rear Speaker Out	Rear Speaker Out	Rear Speaker Out
Gray	-	-	-	Side Speaker Out

11. **USB 2.0 ports 1 and 2.** These two 4-pin Universal Serial Bus (USB) ports are available for connecting USB 2.0 devices.
12. **USB 2.0 ports 3 and 4.** These two 4-pin Universal Serial Bus (USB) ports are available for connecting USB 2.0 devices.
13. **VGA port.** This port is for a VGA monitor or other VGA-compatible devices.

14. **External SATA port.** This port connects to an external Serial ATA hard disk drive. To configure a RAID 0, a RAID 1, or a JBOD set, install an external Serial ATA hard disk drive and an internal Serial ATA hard disk drive to the SATA connector labeled SATA_RAID or SATA_RAID1.

Note: *The external SATA port supports external Serial ATA 3.0 Gb devices. Longer cables support higher power requirements to deliver signals up to two meters away, and enable improved hot-swap function.*

- Note:**
1. *Before creating a RAID set using Serial ATA hard disks, make sure that you have connected the Serial ATA signal cable and installed Serial ATA hard disk drives; otherwise, you cannot enter the JMicron RAID utility and SATA BIOS setup during POST.*
 2. *If you intend to create a RAID configuration using this connector, set the JMicron SATA Controller Mode item in the BIOS to [RAID]. See section "2.4.6 Onboard Device Configuration" for details.*

Caution! *DO NOT insert a different connector to this port.*



DO NOT unplug the external Serial ATA box when a RAID 0 or JBOD is configured.

15. **PS/2 keyboard port (purple).** This port is for a PS/2 keyboard.

1.9.2 Internal Connectors

1. Floppy disk drive connector (34-1 pin FLOPPY)

This connector is for the provided floppy disk drive (FDD) signal cable. Insert one end of the cable to this connector, then connect the other end to the signal connector at the back of the floppy disk drive.

Note: Pin 5 on the connector is removed to prevent incorrect cable connection when using a FDD cable with a covered Pin 5.

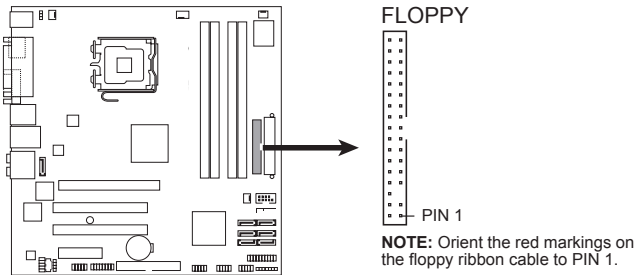

Figure 1.9: Floppy Disk Drive Connector

2. Digital Audio connector (4-1 pin SPDIF_OUT)

This connector is for the S/PDIF audio module to allow digital sound output. Connect one end of the S/PDIF audio cable to this connector and the other end to the S/PDIF module.

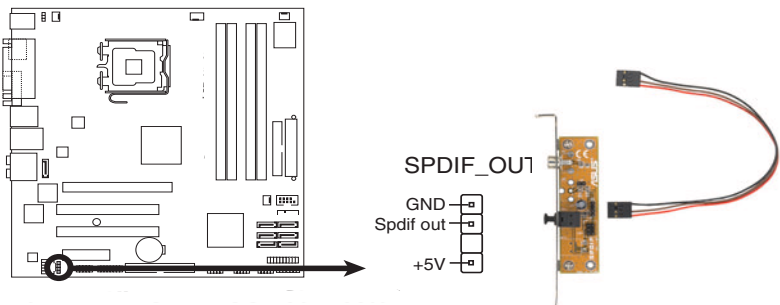

Figure 1.10: SPDIF OUT connector

Note: The S/PDIF out module is purchased separately.

3. IDE connector (40-1 pin PRI_EIDE)

The onboard IDE connector is for the Ultra DMA 133/100/66 signal cable. There are three connectors on each Ultra DMA 133/100/66 signal cable: blue, black, and gray. Connect the blue connector to the motherboard's IDE connector, then select one of the following modes to configure your device.

Drive jumper setting		Mode of device(s)	Cable connector
Single device	Cable-Select or Master	-	Black
Two devices	Cable-Select	Master	Black
		Slave	Gray
	Master	Master	Black or gray
	Slave	Slave	

Note: Pin 20 on the IDE connector is removed to match the covered hole on the Ultra DMA cable connector. This prevents incorrect insertion when you connect the IDE cable.

Use the 80-conductor IDE cable for Ultra DMA 133/100/66 IDE devices.

Note: If any device jumper is set as "Cable-Select," make sure all other device jumpers have the same setting.

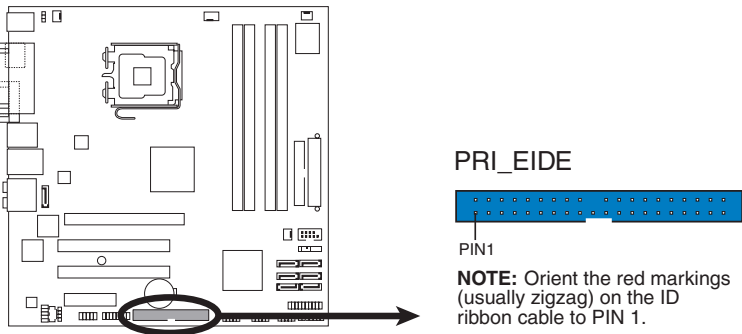

Figure 1.11: AIMB-564 IDE connector

4. ICH8DO Serial ATA connectors (7-pin SATA1 [red], SATA2 [red], SATA3 [red], SATA4 [red], SATA5 [black], SATA6 [black])

These connectors are for the Serial ATA signal cables for Serial ATA hard disk drives.

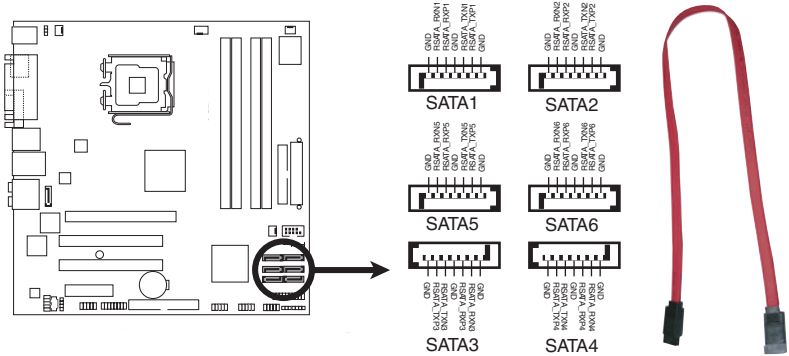
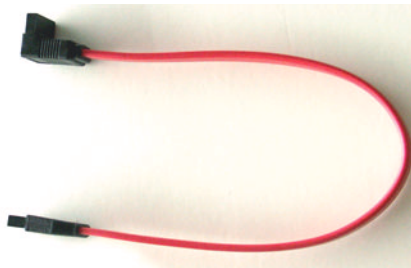

Figure 1.12: SATA connectors

Note: Connect the right-angle side of the SATA signal cable to a SATA device. Or you may connect the right-angle side of the SATA cable to the onboard SATA port to avoid mechanical conflict with large graphics cards.



5. IEEE 1394a port connector (10-1 pin IE1394_2)

This connector is for an IEEE 1394a port. Connect the IEEE 1394a module cable to this connector, then install the module to a slot opening at the back of the system chassis.

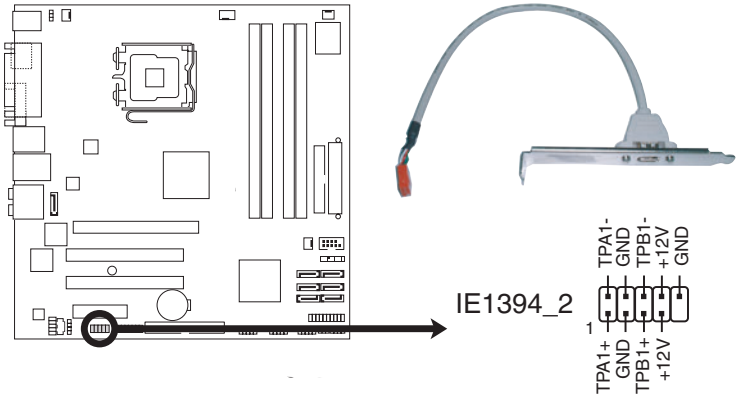

Figure 1.13: IEEE 1394a Connector

Note: The IEEE 1394a module is purchased separately.

6. JMicron JMB363® Serial ATA RAID connector (7-pin SATA_RAID1)

This connector is for a Serial ATA signal cable. This connector supports a Serial ATA hard disk drive, which you can combine with an external Serial ATA hard disk drive to configure for RAID via the onboard Serial ATA RAID controller.

Note: The **JMicron controller mode** item in the BIOS is set to [BASIC] by default.

When set to [RAID], this item allows you to use the connectors to build a RAID set. See section “2.4.6 Onboard Device Configuration” for details.

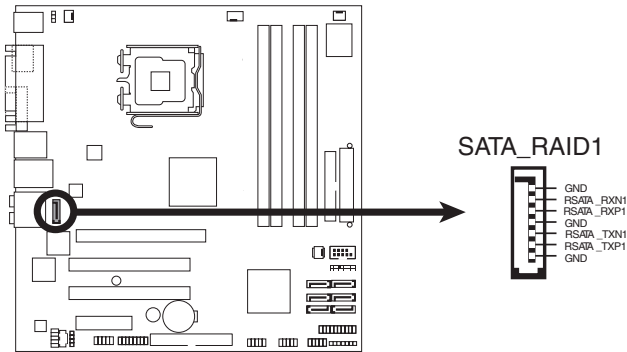

Figure 1.14: SATA RAID connector

Note: Before creating a RAID set using Serial ATA hard disks, make sure that you have connected the Serial ATA signal cables and installed Serial ATA hard disk drives; otherwise, you cannot enter the JMicron® JMB363 RAID utility and SATA BIOS setup during POST.

7. TPM connector (20-pin TPM_SLOT)

This connector supports a Trusted Platform Module (TPM) system, which can securely store keys, digital certificates, passwords, and data. A TPM system also helps enhance network security, protects digital identities, and ensures platform integrity. See section “2.4.3 TPM Configuration” for details.

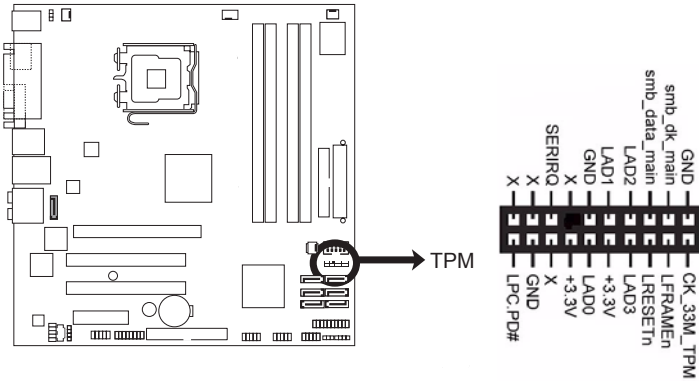

Figure 1.15: TPM connector

8. USB connectors (10-1 pin USB56, USB 78, USB910)

These connectors are for USB 2.0 ports. Connect the USB module cable to any of these connectors, then install the module to a slot opening at the back of the system chassis. These USB connectors comply with USB 2.0 specification that supports a connection speed of up to 480 Mbps.

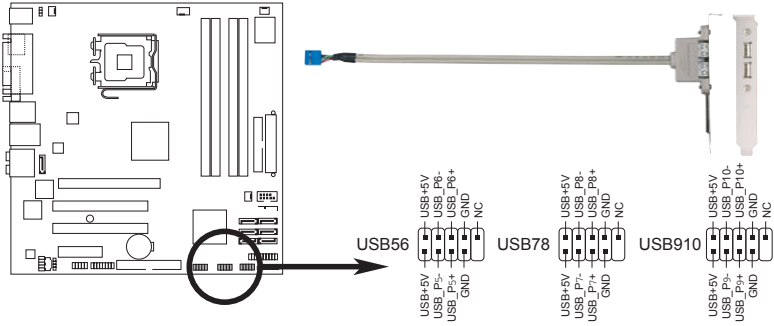

Figure 1.16: USB 2.0 connectors

Caution! Never connect a 1394 cable to the USB connectors. Doing so will damage the motherboard!



Note: The USB module is purchased separately.

9. Optical drive audio connector (4-pin CD)

These connectors allow you to receive stereo audio input from sound sources such as a CD-ROM, TV tuner, or MPEG card.

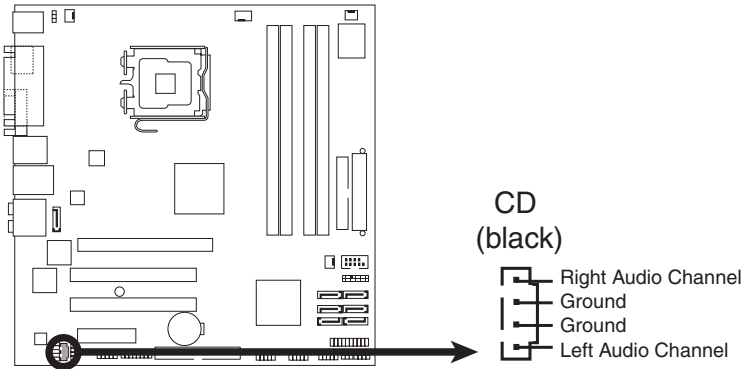

Figure 1.17: Internal Audio Connector

10. CPU, chassis, and power fan connectors (4-pin CPU_FAN, 3-pin CHA_FAN, 3-pin CHA_FAN2, 3-pin PWR_FAN)

The fan connectors support cooling fans of 350 mA ~ 2000 mA (24 W max.) or a total of 1 A ~ 7 A (84 W max.) at +12V. Connect the fan cables to the fan connectors on the motherboard, making sure that the black wire of each cable matches the ground pin of the connector.

Note: *Do not forget to connect the fan cables to the fan connectors. Insufficient air flow inside the system may damage the motherboard components. These are not jumpers! Do not place jumper caps on the fan connectors!*

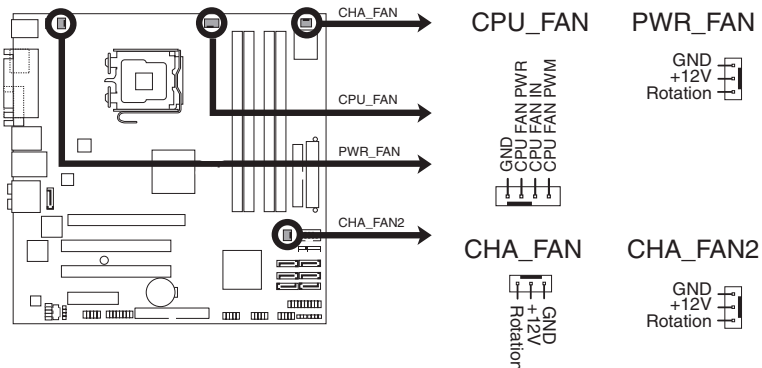

Figure 1.18: Fan connectors

11. Serial port connector (10-1 pin COM1)

This connector is for a serial (COM) port. Connect the serial port module cable to this connector, then install the module to a slot opening at the back of the system chassis.

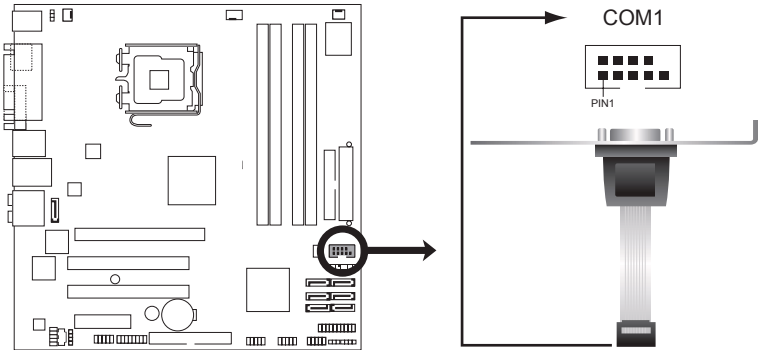

Figure 1.19: Serial port connector

Note: The COM module is purchased separately.

12. Chassis intrusion connector (4-1 pin CHASSIS)

This connector is for a chassis-mounted intrusion detection sensor or switch. Connect one end of the chassis intrusion sensor or switch cable to this connector. The chassis intrusion sensor or switch sends a high-level signal to this connector when a chassis component is removed or replaced. The signal is then generated as a chassis intrusion event.

By default, the pin labeled “Chassis Signal” and “Ground” are shorted with a jumper cap. Remove the jumper caps only when you intend to use the chassis intrusion detection feature.

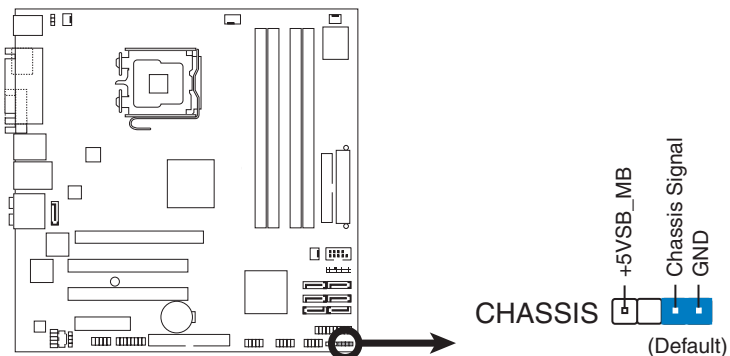

Figure 1.20: Chassis Intrusion connector

13. Front panel audio connector (10-1 pin AAFP)

This connector is for a chassis-mounted front panel audio I/O module that supports either HD Audio or legacy AC'97 audio standard. Connect one end of the front panel audio I/O module cable to this connector.

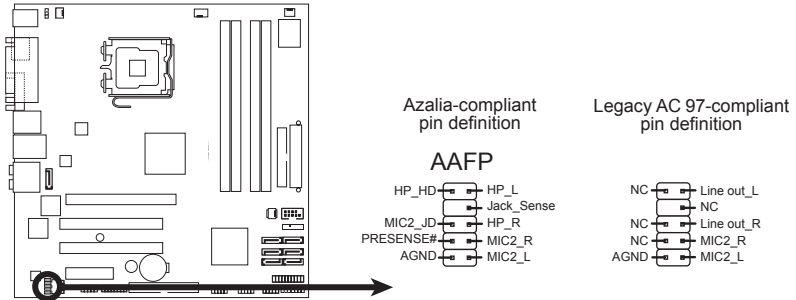

Figure 1.21: Front panel audio connector

Note:

We recommend that you connect a high-definition front panel audio module to this connector to avail of the motherboard's high-definition audio capability.

By default, this connector is set to [HD Audio]. If you want to connect an AC'97 front panel audio module to this connector, set the **Front Panel Support Type** item in the BIOS setup to [AC97]. See section 2.4.6 Onboard Device Configuration for details.

14. ATX power connectors (24-pin EATXPWR, 4-pin EATX12V)

These connectors are for ATX power supply plugs. The power supply plugs are designed to fit these connectors in only one orientation. Find the proper orientation and push down firmly until the connectors completely fit.

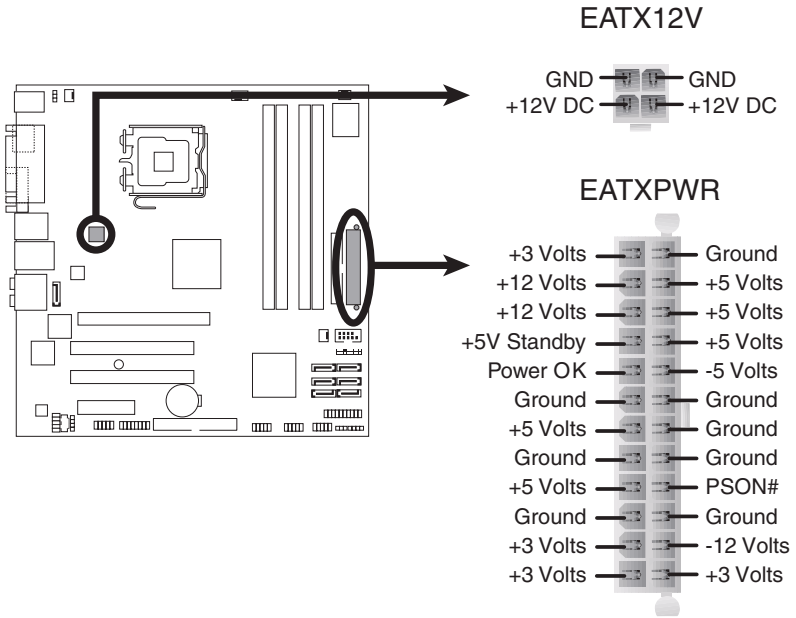

Figure 1.22: ATX Power connector

Note:

1. For a fully configured system, we recommend that you use a power supply unit (PSU) that complies with ATX 12 V Specification 2.0 (or later version) and provides a minimum power of 400 W.
2. Do not forget to connect the 4-pin EATX12V power plug; otherwise, the system will not boot.
3. Use of a PSU with a higher power output is recommended when configuring a system with more power-consuming devices. The system may become unstable or may not boot up if the power is inadequate.
4. The ATX 12 V Specification 2.0-compliant (400W) PSU has been tested to support the motherboard power requirements with the following configuration:
 - CPU: Intel® Pentium® Extreme 3.73GHz
 - Memory: 512 MB DDR2 (x4)
 - Parallel ATA device: IDE hard disk drive
 - Serial ATA device: SATA hard disk drive (x2)
 - Optical drive: DVD-RW

CHAPTER
2

Award BIOS Setup

Chapter 2 Award BIOS Setup

2.1 Introduction

2.1.1 BIOS Setup Program

This motherboard supports a programmable firmware chip that you can update.

Use the BIOS Setup program when you are installing a motherboard, reconfiguring your system, or prompted to “Run Setup”. This section explains how to configure your system using this utility.

Even if you are not prompted to use the Setup program, you can change the configuration of your computer in the future. For example, you can enable the security password feature or change the power management settings. This requires you to reconfigure your system using the BIOS Setup program so that the computer can recognize these changes and record them in the CMOS RAM of the SPI chip.

The firmware chip on the motherboard stores the Setup utility. When you start up the computer, the system provides you with the opportunity to run this program. Press during the Power-On Self-Test (POST) to enter the Setup utility; otherwise, POST continues with its test routines.

If you wish to enter Setup after POST, reboot the system by doing any of the following procedures:

- Restart using the OS standard shut-down procedure.
- Press <Ctrl>+<Alt>+ simultaneously.
- Press the reset button on the system chassis.
- Press the power button to turn the system off then back on.

The Setup program is designed to make it as easy to use as possible.

Being a menu-driven program, it lets you scroll through the various sub-menus and make your selections from the available options using the navigation keys.

Caution!



*Using the **power button**, **reset button**, or the **<Ctrl>+<Alt>+** keys to force a reset from a running operating system can cause damage to your data or system. We recommend to always shut-down the system properly from the operating system.*

- Note:**
1. *The default BIOS settings for this motherboard apply for most conditions to ensure optimum performance. If the system becomes unstable after changing any BIOS settings, load the default settings to ensure system compatibility and stability. Select the Load Setup Defaults item under the Exit Menu.*
 2. *The BIOS setup screens shown in this section are for reference purposes only, and may not exactly match what you see on your screen.*
 3. *Save a copy of the original motherboard BIOS file to a bootable floppy disk or a USB flash disk in case you need to restore the BIOS in the future.*

2.1.2 CMOS RAM Auto-backup and Restore

The CMOS RAM is powered by an onboard button cell battery. When you finish BIOS setup, the data in CMOS RAM will be automatically backed up to Flash ROM. If operation in harsh industrial environments causes a soft error, BIOS will recheck the data in CMOS RAM and automatically restore the original data in Flash ROM to CMOS RAM for booting.

- Note:** *If you intend to change the CMOS setting without restoring the previous backup, you have to click on “DEL” within two seconds of the “CMOS checksum error...” display screen message appearing. Then enter the “Setup” screen to modify the data. If the “CMOS checksum error...” message appears over and over, please check to see if you need to replace the battery in your system.*

2.2 Entering Setup

Turn on the computer and press to enter the BIOS setup.



Figure 2.1: Award BIOS Setup initial screen

2.3 Standard CMOS Setup

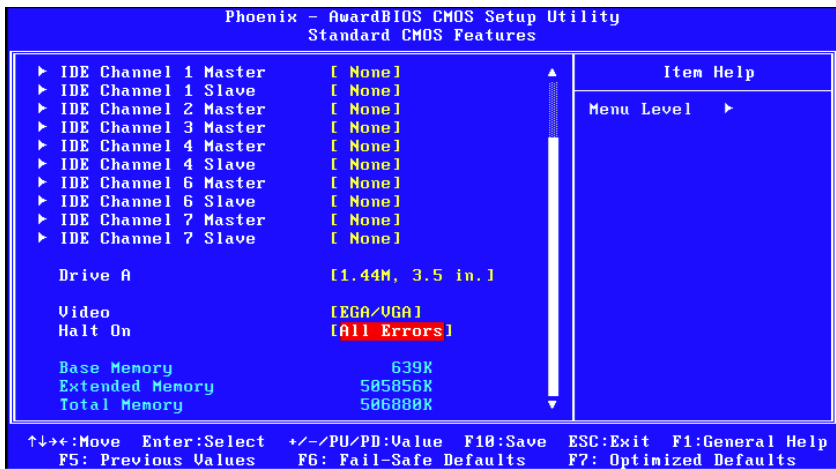
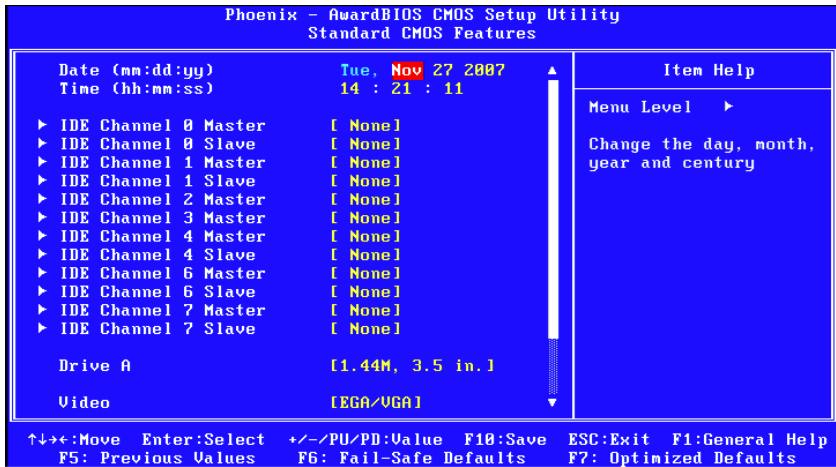

Figure 2.2: Standard CMOS Features Screen

2.3.1 Date

The date format is <weeks>, <months>, <days>, <years>.

2.3.2 Time

The time format is <hours> <minutes> <seconds>, based on the 24-hour clock.

2.3.3 IDE Channel 0/1 Master/Slave

- **IDE HDD Auto-Detection:** Press “Enter” to select this option for automatic device detection.
- **IDE Device Setup:**
 - Auto:** Automatically detects IDE devices during POST
 - None:** Select this when no IDE device is used. The system will skip the auto-detection step to make system start up faster.
 - Manual:** User can manually input the correct settings.
- **Access Mode:** The options are CHS/LBA/Large/Auto
- **Capacity:** Capacity of currently installed hard disk.
- **Cylinder:** Number of cylinders
- **Head:** Number of heads
- **Precomp:** Write precomp
- **Landing Zone:** Landing zone
- **Sector:** Number of sectors

2.3.4 Drive A / Drive B

This category identifies the types of floppy disk drives installed in the system. The options are: None/360K, 5.25"/1.2M, 5.25"/720K, 3.5"/1.44M, 3.5"/2.88M, 3.5".

2.3.5 Video

This category detects the type of adapter used for the primary system monitor that must match your video display card and monitor.

- **EGA / VGA:** Enhanced Graphics Adapter/Video Graphics Array. For EGA, VGA, SVGA, or PGA monitor adapters.
- **CGA 40:** Color Graphics Adapter, power up in 40 column mode.
- **CGA 80:** Color Graphics Adapter, power up in 80 column mode.
- **MONO:** Monochrome adapter, includes high resolution monochrome adapters

2.3.6 Halt On

This category determines whether system start-up will halt or not when an error is detected during power up.

The options are: No Errors/ All Errors/ All, But Keyboard/ All, But Diskette/ All, But Disk/Key

2.3.7 Memory

This category displays base memory, extended memory, and total memory detected during POST (Power On Self Test).

2.4 Advanced BIOS Features

The “Advanced BIOS Features” screen appears when choosing the “Advanced BIOS Features” item from the “Initial Setup Screen” menu. It allows the user to configure the AIMB-764 according to his particular requirements. Below are some major items that are provided in the Advanced BIOS Features screen. A quick booting function is provided for your convenience. Simply enable the Quick Booting item to save yourself valuable time.

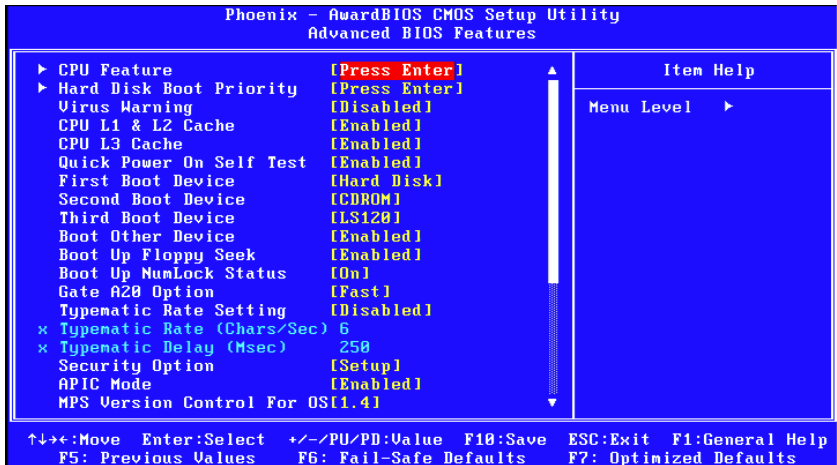

Figure 2.3: Advanced BIOS Features screen

2.4.1 CPU Features

Thermal Management

This feature controls the activation of the Thermal Monitor's automatic mode. It allows you to determine when the Pentium 4's Thermal Monitor should be activated in automatic mode after the system boots. For example, with the default value of 16 Minutes, the BIOS activates the Thermal Monitor in automatic mode 16 minutes after the system starts booting up. The choices are 4 Min, 8 Min, 16 Min, and 32 Min.

Limit CPUID MaxVal

Set Limit CPUID MaxVal to 3. This should be disabled for WinXP.

C1E Function:

Sets the CPU C1E function.

Execute Disable Bit

When disabled, forces the XD feature flag to always return 0.

2.4.2 Hard Disk Boot Priority

Set hard disk boot device priority.

2.4.3 Virus Warning

Enables or disables the virus warning.

2.4.4 CPU L1, L2 & L3 Cache

Enabling this feature speeds up memory access. The commands are "Enabled" or "Disabled."

2.4.5 Quick Power On Self Test

This allows the system to skip certain tests to speed up the boot-up procedure.

2.4.6 First/Second/Third Boot Device

The BIOS tries to load the OS from the devices in the sequence set here. The options are: "Floppy", "LS120", "Hard disk", "CDROM", "ZIP100", "USB-FDD", "USB-ZIP", "USBCDROM", "USB-HDD", "LAN", and "Disabled".

2.4.7 Boot Other Device

Use this to boot another device. The options are "Enabled" and "Disabled".

2.4.8 Swap Floppy Drive

If the system has two floppy drives, choose “Enabled” to assign physical drive B to logical drive A and vice-versa. The commands are “Enabled” or “Disabled”.

2.4.9 Boot Up Floppy Seek

Selection of the command “Disabled” will speed the boot up. Selection of “Enabled” searches disk drives during boot up.

2.4.10 Boot Up NumLock Status

Sets the boot up status Num Lock. The options are “On” and “Off”.

2.4.11 Gate A20 Option

“Normal”: A pin in the keyboard controller controls GateA20. Fast (Default) lets chipset control GateA20.

2.4.12 Typematic Rate Setting

The typematic rate is the rate key strokes repeat as determined by the keyboard controller. The commands are “Enabled” or “Disabled”. Enabling allows the typematic rate and delay to be selected.

2.4.13 Typematic Rate (Chars/Sec)

The BIOS accepts the following input values (characters/second) for typematic rate: 6, 8, 10, 12, 15, 20, 24, and 30.

2.4.14 Typematic Delay (msec)

Typematic delay is the time interval between the appearances of two consecutive characters, when the key is continuously depressed. The input values for this category are: 250, 500, 750, and 1000 (ms).

2.4.15 Security Option

This category determines whether the password is required when the system boots up or only when entering setup. The options are:

- **System:** The system will not boot, and access to Setup will be also denied unless the correct password is entered at the prompt.
- **Setup:** The system will boot, but access to Setup will be denied unless the correct password is entered at the prompt.

Note: *To disable security, select PASSWORD SETTING in the main menu. Then, you will be asked to enter a password. Simply press <Enter> to disable security. When security is disabled, the system will boot and you can enter Setup freely.*

2.4.16 APIC Mode

Allows you to enable Advanced Configuration and power Interface (ACPI) support in the Advanced Programmable Interrupt Controller (APIC).

2.4.17 MPS Version Control For OS

(Supports Multi Processor Specification revision 1.4)

Note: *Some old MPS OS support 1.1 version only.*

81.4 Support MPS Version 1.4. (Default Value)

81.1 Support MPS Version 1.1.

2.4.18 OS Select For DRAM > 64MB

Select an operating system that is running with greater than 64MB of RAM on the system. The choices: Non-OS2, OS2.

2.5 Advanced Chipset Features

By choosing the “Advanced Chipset Features” option from the “Initial Setup Screen” menu, the screen below will be displayed. This sample screen contains the manufacturer’s default values for the AIMB-764, as shown in Figure 3.4:

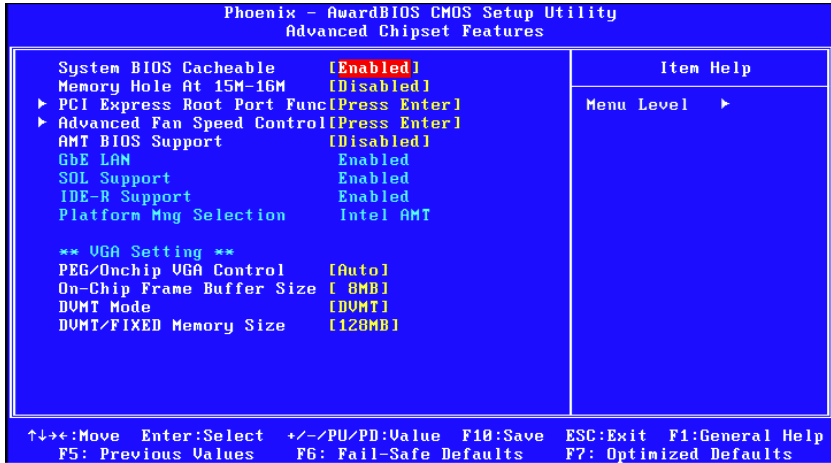

Figure 2.4: Advanced Chipset Features screen

Note: *DRAM default timings have been carefully chosen and should ONLY be changed if data is being lost. Please first contact technical support.*

2.5.1 Memory Hole At 15M-16M

Enabling this feature reserves 15 MB to 16 MB memory address space for ISA expansion cards that specifically require this setting. This makes memory from 15 MB and up unavailable to the system. Expansion cards can only access memory up to 16 MB. The default setting is “Disabled”.

2.5.2 Configure AMT BIOS Support (Intel® Active Management Technology)

Intel AMT Support [Enabled]

Allows you to enable or disable the Intel® AMT (Active Management Technology). Configuration options: [Disabled] [Enabled]

Intel® Active Management Technology is the next generation of client manageability via the wired network. Intel AMT is a set of advanced manageability features developed as a direct result of IT customer feedback gained through Intel market research. With the new implementation of System Defense in ICH8DO, the advanced manageability feature set of Intel AMT is further enhanced. Further details please browse Intel web site: www.intel.com.

Warning! *Intel® Active Management Technology requires Intel® AMT-enabled software. Also, the platform must be connected to a power source and an active LAN port.*



2.5.3 PEG / Onchip VGA Control

Use this field to select PEG or Onchip VGA. The default is AUTO.

2.5.4 On-Chip Frame Buffer Size

The On-Chip Frame Buffer Size can be set to 1 MB or 8 MB. This memory is shared with the system memory.

2.5.5 DVMT Mode

Displays the active system memory mode.

2.5.6 DVMT / FIXED Memory Size

Specify the size of DVMT / FIXED system memory to allocate for video memory.

2.6 Integrated Peripherals

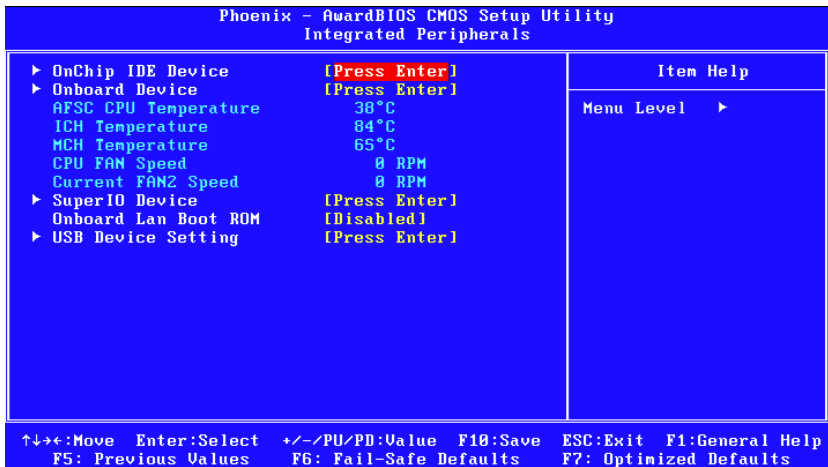

Figure 2.5: Integrated peripherals

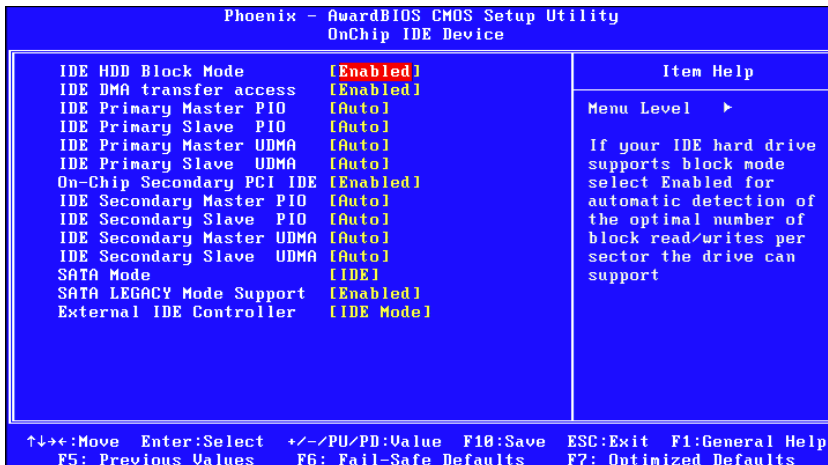

Figure 2.6: On-Chip IDE Device

2.6.1 On board Lan Boot ROM:

Options are “Enabled” and “Disabled”. Select “Disabled” if you don’t want to use the onboard LAN option ROM.

2.6.2 IDE HDD Block Mode

If your IDE hard drive supports block mode select “Enabled” for automatic detection of the optimal number of block read/writes per sector the drive can support.

2.6.3 IDE DMA Transfer Access

Use this field to enable or disable IDE DMA transfer access.

2.6.4 On-Chip Primary / Secondary IDE Device

IDE Primary Master/Slave PIO/UDMA Mode (Auto). The channel has both a master and a slave, making four IDE devices possible. Because two IDE devices may have a different Mode timing (0, 1, 2, 3, 4), it is necessary for these to be independent. The default setting “Auto” will allow auto detection to ensure optimal performance.

2.6.5 SATA Mode

The setting choices for the SATA Mode are IDE, RAID and AHCI Mode. Select [IDE] if you want to have SATA function as IDE. Select [AHCI] for Advanced Host Controller Interface (AHCI) feature, with improved SATA performance and native command queuing. Select [RAID] to use SATA for RAID.

2.6.6 Legacy Mode Support

This allows SATA system to support PATA mode. The choices are “Disabled” and “Enabled”.

Note: *Please refer to the PDF document Intel® Matrix Storage Technology Quickstartguide and Intel® Matrix Storage Manager User's Manual on this CD (in the MANUAL folder) to understand the necessary steps to build and configure your RAID 0, 1, 10, 5 system using the Intel® Matrix Storage Technology and Matrix Storage Manager.*

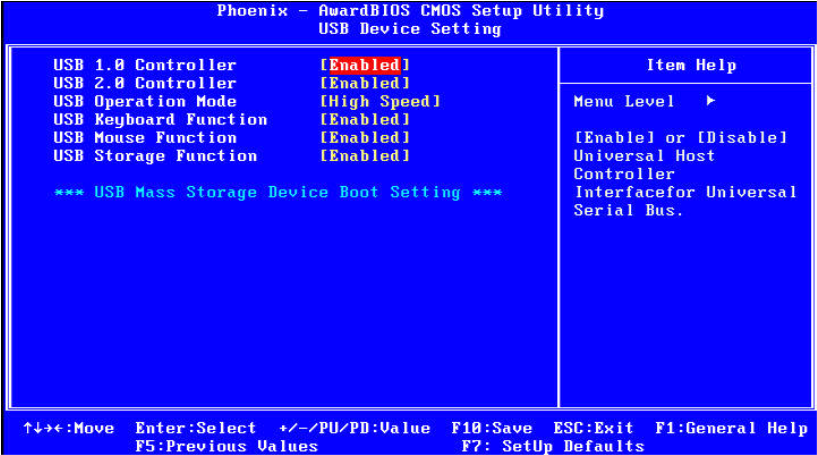

Figure 2.7: USB device setting

2.6.7 USB 1.0 Controller

Select “Enabled” if your system contains a Universal Serial Bus (USB) controller and you have USB peripherals. The choices are “Enabled” and “Disabled”.

2.6.8 USB Operation Mode

Set the USB 2.0 controller to Hi Speed (480 Mbps) or Full Speed (12 Mbps).

2.6.9 USB Storage Function:

Select “Enabled” if you plan to use an external USB storage device to boot system under DOS mode. The choices are “Enabled” and “Disabled”.

2.6.10 USB 2.0 Controller

This entry is used to disable/enable the USB 2.0 controller only. The BIOS itself may or may not have high-speed USB support. If the BIOS has high speed USB support built in, the support will automatically turn on when a high speed device is attached. The choices are “Enabled” or “Disabled”.

2.6.11 USB Keyboard / Mouse Support

Select “Enabled” if you plan to use a USB keyboard. The choices are “Enabled” and “Disabled”.

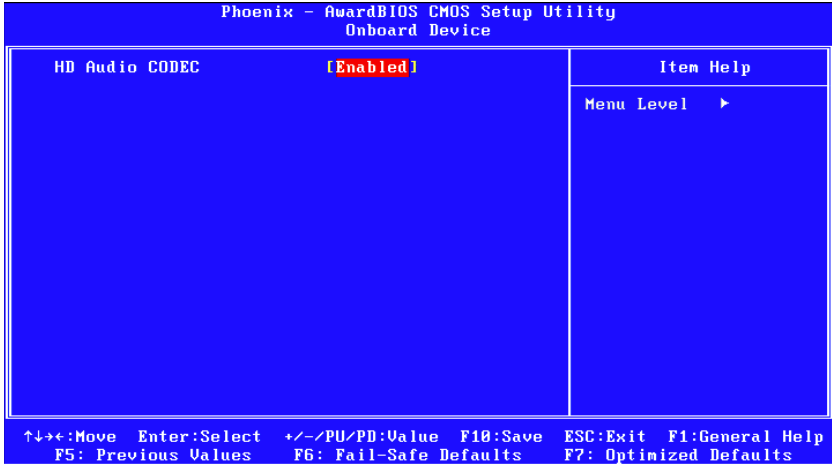

Figure 2.8: Onboard Device

2.6.12 HD Audio Codec

Allows you to enable or disable the High Definition Audio Controller. Configuration options: [Enabled] [Disabled]

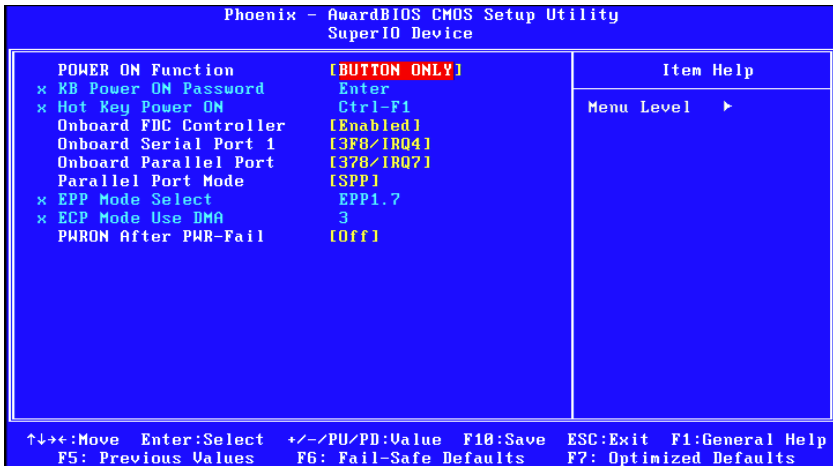

Figure 2.9: Super I/O Device

2.6.13 Onboard FDC Controller

When enabled, this field allows you to connect your floppy disk drives to the onboard floppy disk drive connector instead of a separate controller card. If you want to use a different controller card to connect the floppy disk drives, set this field to Disabled.

2.6.14 Onboard Serial Port 1

The settings are “3F8/IRQ4”, “2F8/IRQ3”, “3E8/IRQ4”, “2E8/IRQ3”, and “Disabled” for the on-board serial connector.

2.6.15 Onboard Serial Port 2

The settings are “3F8/IRQ4”, “2F8/IRQ3”, “3E8/IRQ4”, “2E8/IRQ3”, and “Disabled” for the on-board serial connector.

2.6.16 Onboard Parallel Port

This field sets the address of the on-board parallel port connector. You can select “378/IRQ7”, “278/IRQ5”, “3BC/IRQ7”, or “Disabled”. If you install an I/O card with a parallel port, make sure there is no conflict in the address assignments. The single board computer can support up to three parallel ports.

2.6.17 Parallel Port Mode

This field allows you to set the operation mode of the parallel port. The setting “Normal” allows normal speed operation, but in one direction only. “EPP” allows bidirectional parallel port operation at maximum speed. “ECP” allows the parallel port to operate in bidirectional mode and at a speed faster than the maximum data transfer rate. “ECP + EPP” allows normal speed operation in two-way mode.

2.6.18 EPP Mode Select

This field allows you to select EPP port type 1.7 or 1.9. The choices are “EPP1.9” and “EPP1.7”.

2.6.19 ECP Mode Use DMA

This selection is available only if you select “ECP” or “ECP + EPP” in the Parallel Port Mode field. In ECP Mode, you can select DMA channel 1 or DMA channel 3. Leave this field on the default setting.

2.6.20 PWRON After PWR-Fail

Use this to set up the system after power failure. The “Off” setting keeps the system powered off after power failure, the “On” setting boots up the system after failure.

2.7 Power Management Setup

The power management setup controls the single board computer's “green” features to save power. The following screen shows the manufacturer’s defaults.

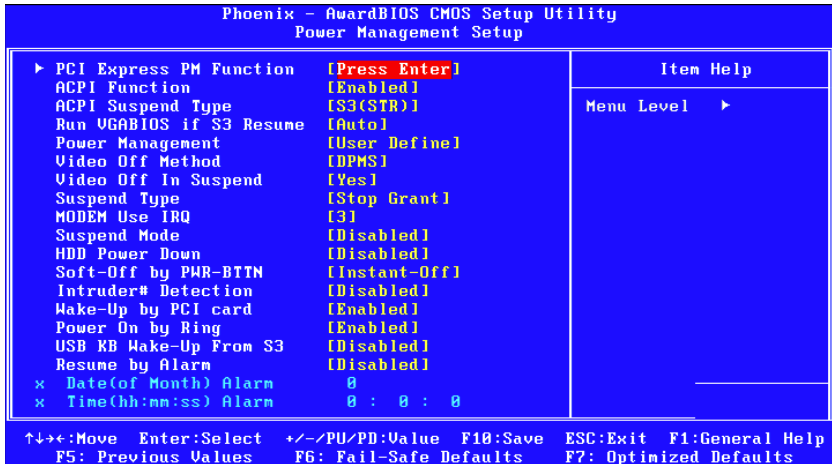

Figure 2.10: Power management setup screen

2.7.1 ACPI Function

The choices are: “Enabled” and “Disabled”.

2.7.2 ACPI Suspend Type

This item allows you to set ACPI suspend type to S1/POS(Power On Suspend).

2.7.3 Run VGA BIOS if S3 Resume

Select “Auto” to run VGA BIOS if S3 resumes automatically. “Yes” enables running VGA BIOS if S3 resumes. “No” disables this function.

2.7.4 Power Management

This category allows you to select the type (or degree) of power saving and is directly related to the following modes:

- HDD Power Down
- Suspend Mode

There are three selections for Power Management, and they have fixed mode settings.

Table 2.1: Power Saving

Saving Mode	Function
Min Saving	Minimum power management., Suspend Mode = 1 hr., and HDD Power Down = 15 min.
Max Saving	Maximum power management., Suspend Mode = 1 min., and HDD Power Down = 1 min.
User Defined (Default)	Allows you to set each mode individually. When not disabled, each of the ranges are from 1 min. to 1 hr. except for HDD Power Down which ranges from 1 min. to 15 min., and disabled.

2.7.5 Video Off Method

Use this to select the method to turn off the video. The choices are “Blank Screen”, “V/H SYNC+ Blank”, and “DPMS”.

2.7.6 Video Off In Suspend

When the system is in suspend mode, the video will turn off. The choices are “No” and “Yes”.

2.7.7 Suspend Type

The choices are “Stop Grant” and “PwrOn Suspend”.

2.7.8 Suspend Mode

Please refer to 3.7.5.

2.7.9 HDD Power Down

Please refer to 3.7.5.

2.7.10 Soft-Off by PWR-BTTN

If you choose “Instant-Off”, then pushing the ATX soft power switch button once will switch the system to “system off” power mode. You can choose “Delay 4 sec”. If you do, then pushing the button for more than 4 seconds will turn off the system, whereas pushing the button momentarily (for less than 4 seconds) will switch the system to “suspend” mode.

2.7.11 PowerOn by Modem or Power On by Ring

To enable or disable the function to power on the system via a Modem connection from a remote host. The choice “Enabled” and “Disabled”.

2.7.12 USB KB Wake Up From S3

When enabled, enter any key to wake up the system from S3 state. The choices are “Enabled” and “Disabled”.

2.7.13 PowerOn by Alarm or Resume by Alarm

The choices are “Enabled” and “Disabled”. Fields that follow below indicate date of current month and time of alarm settings, if enabled.

2.7.14 Wake-Up by PCI card

When enabled, the system will resume from suspend mode if Primary IDE 0 (1) or Secondary IDE 0 (1) becomes active. The choices are “Enabled” and “Disabled”.

2.7.15 FDD, COM, LPT PORT

When enabled, the system will resume from suspend mode if the FDD, interface, COM port, or LPT port is active. The choices are “Enabled” and “Disabled”.

2.7.16 PCI PIRQ [A-D]#

When enabled, the system resumes from suspend mode if an interrupt occurs. The choices are “Enabled” and “Disabled”.

2.8 PnP/PCI Configuration

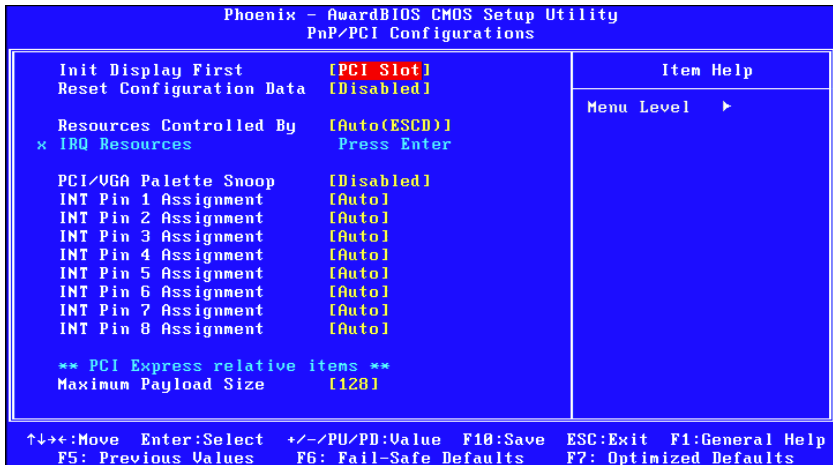

Figure 2.11: PnP/PCI configurations screen

2.8.1 Init Display First

Choose the first display interface to initiate while booting. The choice is “PCI Slot” or “Onboard”.

2.8.2 Reset Configuration Data

The default is “Disabled”. Select “Enabled” to reset Extended System Configuration Data (ESCD) if you have installed a new add-on card, and system configuration is in such a state that the OS cannot boot.

2.8.3 Resources Controlled By

The commands here are “Auto(ESCD)” or “Manual”. Choosing “Manual” requires you to choose resources from the following sub-menu. “Auto(ESCD)” automatically configures all of the boot and Plug and Play devices, but you must be using Windows 95 or above.

2.8.4 PCI / VGA Palette Snoop

This is set to “Disabled” by default.

2.8.5 Maximum Payload Size

This allows you to set the maximum TLP payload size for PCIe devices. The options are [128 bytes].

2.9 PC Health Status

Phoenix - AwardBIOS CMOS Setup Utility	
PC Health Status	
CPU FAN Profile Mode	[Silent Mode]
System Temperature	45°C / 113°F
CPU Temperature	38°C / 100°F
CHASSIS1 FAN	0 RPM
CPU FAN	1110 RPM
POWER FAN	0 RPM
CHASSIS2 FAN	0 RPM
Vcore	1.270V
+12V	12.030V
+5V	5.020V
VCC (V)	3.180V
VBAT (V)	3.280V
3VSB (V)	3.280V

Item Help
Menu Level ▶

↑↓+:-:Move	Enter:Select	+/-/PU/PD:Value	F10:Save	ESC:Exit	F1:General Help
F5: Previous Values	F6: Fail-Safe Defaults	F7: Optimized Defaults			

Figure 2.12: PC Health Status Screen

2.9.1 System Temperature

This shows you the current temperature of system.

2.9.2 CPU FAN Speed

This shows the current CPU FAN operating speed.

2.9.3 System FAN Speed

This shows the current System FAN, including Power and Chassis fan, operating speed.

2.9.4 VCORE and Other Voltages

This shows the voltage of VCORE, +3.3, +5V, +12V, -12V and VBAT(V).

2.10 Frequency / Voltage Control

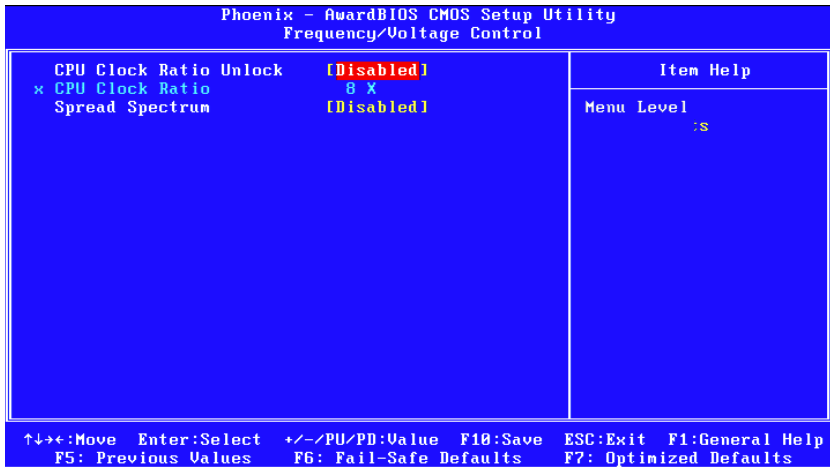

Figure 2.13: Spread Spectrum Frequency/Voltage Control screen

2.10.1 CPU Clock Ratio Unlock

It is suggested to keep this set this as disabled.

2.10.2 CPU Clock Ratio

Set CPU Ratio if CPU Ratio unlock is enabled.

The range is 8X~24X, depending on CPU Clock Ratio.

2.10.3 Spread Spectrum

This setting allows you to reduce EMI by modulating the signals the CPU generates so that the spikes are reduced to flatter curves. This is achieved by varying the frequency slightly so that the signal does not use any particular frequency for more than a moment. The choices are “Disabled” and “Enabled”.

2.11 TPM Support

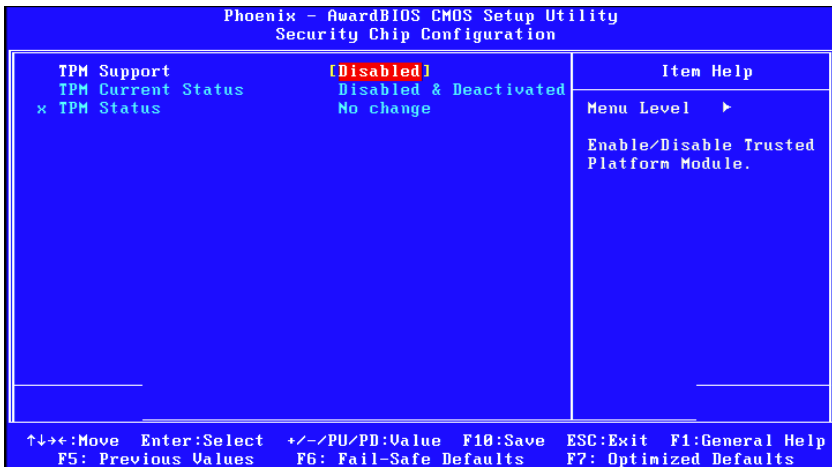

Figure 2.14: Security Chip Configuration

The items in this menu allow you to set the TPM (Trusted Platform Module) features. Select an item and then press <Enabled> to display the configuration options.

2.11.1 TPM Support [Disabled]

This item is not configurable.

2.11.2 TPM Status [No Change]

This item is not configurable.

Note: *To enable the TPM function, set the TPM Support item to [Enabled] and then save the change (see 2.13 Exit menu. for details). After rebooting, the TPM Configuration menu will change into the following one.*

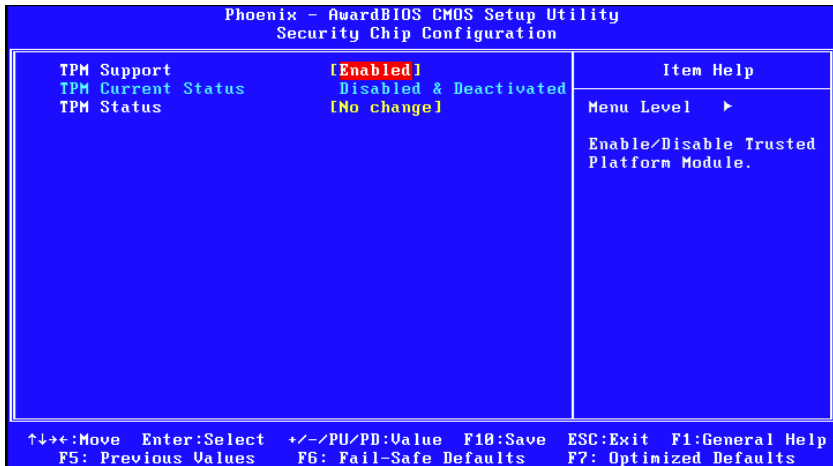

Figure 2.15: Security Chip Configuration

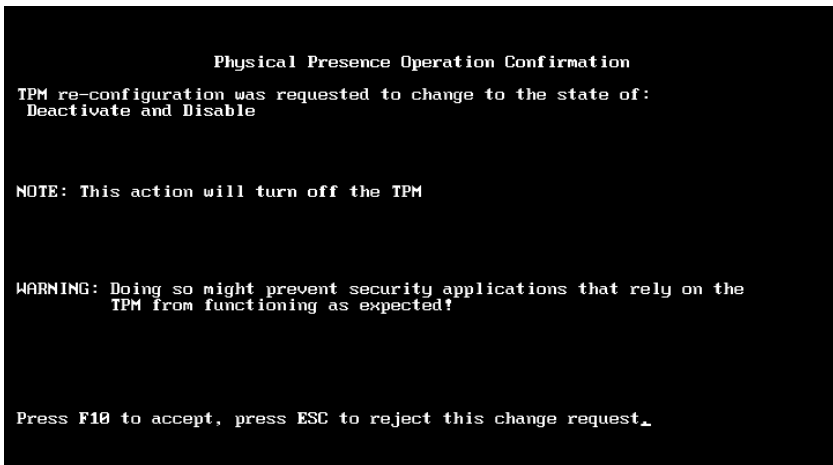

Figure 2.16: TPM POST Screen

Caution! Once the data saved in the TPM security chip is cleared, it can never be restored.



2.12 Password Setting

Follow these steps to change the password.

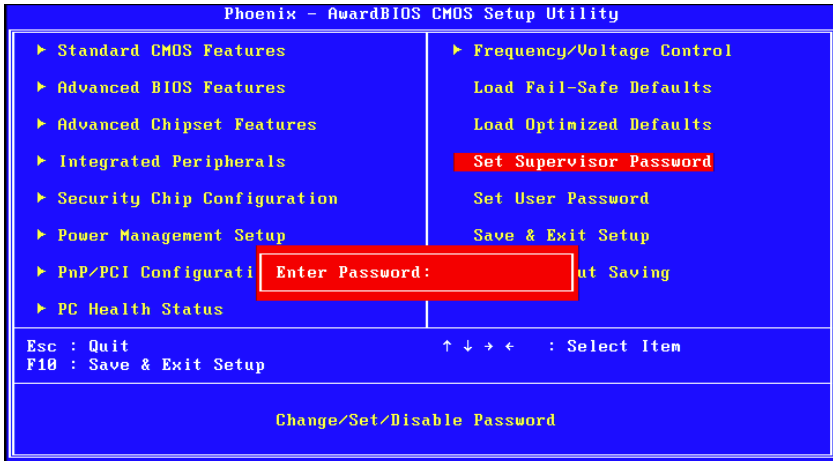

1. Choose the “Set Password” option from the “Initial Setup Screen” menu and press <Enter>. The screen displays the following message:

Please Enter Your Password

2. Press <Enter>.
3. If the CMOS is good and this option has been used to change the default password, the user is asked for the password stored in the CMOS. The screen displays the following message:

Please Confirm Your Password

4. Type the current password and press <Enter>.
5. After pressing <Enter> (ROM password) or the current password (user-defined), you can change the password stored in the CMOS. The password must be no longer than eight (8) characters. Remember, to enable the password setting feature, you must first select either “Setup” or “System” from the “Advanced BIOS Features” menu.

2.13 Save & Exit Setup

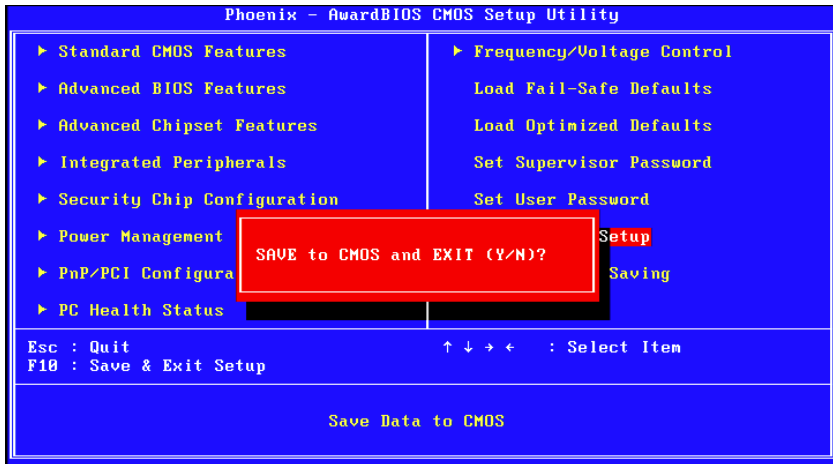

If you select this and press <Enter>, the values entered in the setup utilities will be recorded in the CMOS memory of the chipset. The processor will check this every time you turn your system on and compare this to what it finds as it checks the system. This record is required for the system to operate.

2.14 Exit Without Saving

Selecting this option and pressing <Enter> lets you exit the setup program without recording any new values or changing old ones.

