

REV.	DATE	DESCRIPTION
NC	12/13/00	INITIAL RELEASE
A	05/06/07	REVISE BARREL/FERRULE DIMENSIONS/UPDATE DRAWING FORMAT
B	01/06/08	ADD CABLE CALL OUT IN DESCRIPTION. REMOVE NOTE 2

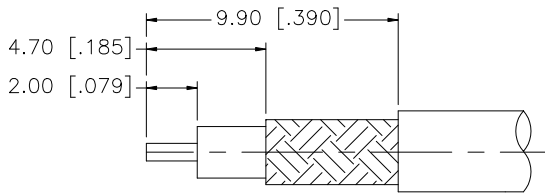

RECOMMENDED CABLE STRIPPING DIM'S

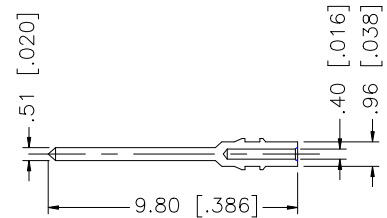
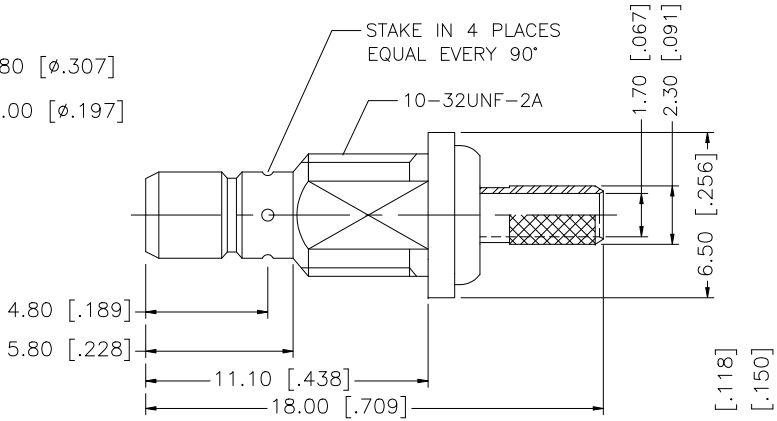
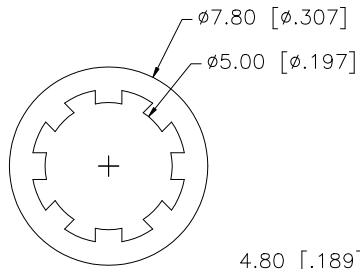
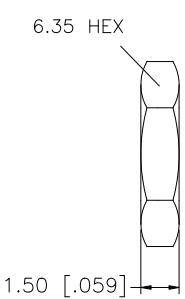
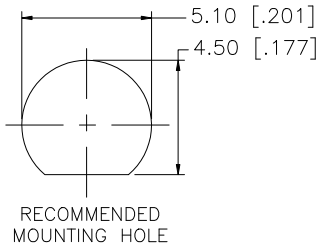
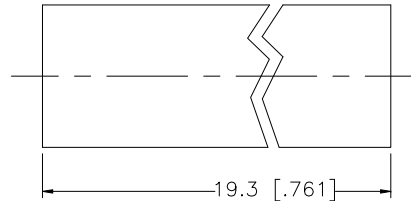
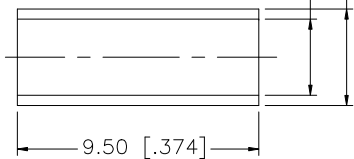

NOTE:
1. CRIMPED FERRULE HEX CRIMP SIZE .128"

QTY	DESCRIPTION	MATERIAL	FINISH
1	HEAT SHRINK TUBE	BLACK	
1	HEX NUT	BRASS	NICKEL
1	LOCK WASHER	BRASS	NICKEL
1	FERRULE	COPPER	NICKEL
1	CONTACT PIN	BRASS	GOLD
1	INSULATOR	TEFLON	NATURAL
1	BODY	BRASS	NICKEL

UNLESS OTHERWISE SPECIFIED DIMENSIONS ARE IN MILLIMETERS. DIMENSIONS IN [] ARE IN INCHES AND FOR CUSTOMER REFERENCE ONLY.

UNLESS OTHERWISE SPECIFIED TOLERANCES FOR MILLIMETERS ARE:
0.5 - 8mm ± 0.20mm
8 - 30mm ± 0.40mm
30 - 120mm ± 0.50mm

UNLESS OTHERWISE SPECIFIED TOLERANCES FOR INCHES ARE:
.020 - .315 = ± 0.007"
.315 - 1.180 = ± 0.015"
1.180 - 4.724 = ± 0.020"

DO NOT SCALE DRAWING

APPROVALS	DATE
DRAWN G.R.S.	01/06/08
CHECKED	
ISSUED	
SHEET 1 OF 1	
CAD FILE C:/142/142179-75.DWG	

Amphenol Connex

PART DESCRIPTION
**MINI SMB BULKHEAD CRIMP JACK
(FOR RG-179/U, 187/U CABLE)**

PART NO.
142179-75

DWG. NO.	142179-75.DWG	REV.	B	SIZE	A	SCALE	NA
----------	---------------	------	---	------	---	-------	----