

PERFORMANCE PLASTIC PACKAGE ULTRA MINIATURE PURE SILICON™ CLOCK OSCILLATORS

ASDMP



2.5 x 2.0 x 0.85 mm

ASDMP Series

Moisture Sensitivity Level – MSL 1



RoHS
Compliant

FEATURES:

- Ultra Miniature Pure Silicon™ Clock Oscillator
- High Performance MEMS Technology by Discera
- Low Power Consumption for high speed communication
- Exceptional Stability Over Temp. at -40 to +85°C, ±15ppm
- Extended Automotive Grade Temp. stability at -55 to +125°C, ±25ppm
- Available in 50kG Shock Resistance Configuration upon request
- MIL-STD-883 shock and vibration compliant
- Durable QFN Plastic Compact Packaging
- Standby or Disable Tri-state function
- Low jitter (Period jitter RMS and Phase jitter RMS)
- High power supply noise reduction, -50dBc

APPLICATIONS:

- Storage Area Networks (SATA, SAS, Fiber Channel)
- Passive Optical Networks (EPON, 10G-EPON, GPON, 10G-PON)
- Ethernet (1G, 10GBASE-T/KR/LR/SR, FCoE)
- HD/SD/SDI Video & Surveillance
- PCI Express
- Display port

STANDARD SPECIFICATIONS:

Common Key Electrical Specifications – CMOS, LVPECL, LVDS, and HCSL

| Parameters | Minimum | Typical | Maximum | Units | Notes | |
|--------------------------------------|--|---------|---------|---------|--------------------------------|-----------------------------------|
| Frequency Range | CMOS | 10.000 | ----- | 170.000 | MHz | Commercial, Industrial Temp range |
| | CMOS | 10.000 | ----- | 100.000 | | Automotive -55 ~ +125°C |
| | LVPECL | 10.000 | ----- | 460.000 | | Commercial, Industrial Temp range |
| | LVDS | 10.000 | ----- | 460.000 | | Commercial, Industrial Temp range |
| | HCSL | 10.000 | ----- | 460.000 | | Commercial, Industrial Temp range |
| Operating Temperature | -20 | ----- | +70 | °C | See options | |
| Storage Temperature | -55 | ----- | +150 | °C | | |
| Overall Frequency Stability | -50 | ----- | +50 | ppm | See options | |
| Supply Voltage (Vdd) | +2.25 | ----- | +3.6 | V | | |
| Startup Time | ----- | ----- | 5 | ms | | |
| Enable Time | ----- | ----- | 20 | ns | STD (Tri-state) | |
| | ----- | ----- | 5 | ms | PD option (Power Down) | |
| Disable Time | ----- | ----- | 5 | ns | | |
| Stand-by Current | ----- | 20 | 22 | mA | STD (Tri-state) | |
| Disable Current | ----- | ----- | 0.095 | | PD option (Power Down) | |
| Tri-state Function (Standby/Disable) | "1" (VIH ≥ 0.75*Vdd) or Open: Oscillation "0" (VIL < 0.25*Vdd) : Hi Z | | | V | 40kΩ pull-up resistor embedded | |
| Aging | -5.0 | ----- | +5.0 | ppm | First year | |

Key Electrical Specifications – CMOS

| Parameters | Minimum | Typical | Maximum | Units | Notes |
|--|-----------------|---------------------|---------------------|-------|------------------------|
| Supply Current (I _{dd}) | ----- | 31 | 35 | mA | CL=15pF, 125MHz |
| Output Logic Level | V _{OH} | 0.9*V _{dd} | ----- | V | I _F =±6mA |
| | V _{OL} | ----- | 0.1*V _{dd} | V | |
| Rise Time | ----- | 1.1 | 2.0 | ns | CL=15pF 20%/80%*VDD |
| Fall Time | ----- | 1.3 | 2.0 | ns | |
| Duty Cycle | 45 | ----- | 55 | % | |
| Integrated Phase Jitter (J _{PH}) | ----- | 0.30 | 2 | ps | 200kHz ~ 20MHz@125MHz |
| | ----- | 0.38 | 2 | | 100kHz ~ 20MHz@125MHz |
| | ----- | 1.70 | 2 | | 12kHz ~ 20MHz@125MHz |
| Period Jitter RMS (J _{PER}) | ----- | 3.0 | ----- | ps | |

ABRACON IS
ISO 9001:2008
CERTIFIED



ABRACON
CORPORATION

Visit www.abracon.com for Terms & Conditions of Sale
30332 Esperanza, Rancho Santa Margarita, California 92688
tel 949-546-8000 | fax 949-546-8001 | www.abracon.com

Revised: 08.27.12

PERFORMANCE PLASTIC PACKAGE ULTRA MINIATURE PURE SILICON™ CLOCK OSCILLATORS

ASDMP



2.5 x 2.0 x 0.85 mm

ASDMP Series



RoHS
Compliant

Key Electrical Specifications – LVPECL

| Parameters | | Minimum | Typical | Maximum | Units | Notes |
|--|----------|---------------|---------|---------------|-------|--------------------------------|
| Supply Current (I_{dd}) | | ----- | 56.5 | 58 | mA | RL=50Ω |
| Output Logic Level | V_{OH} | $V_{dd}-1.08$ | ----- | ----- | V | RL=50Ω |
| | V_{OL} | ----- | ----- | $V_{dd}-1.55$ | V | |
| Peak to Peak Output Swing (V_{pp}) | | ----- | 800 | ----- | mV | Single ended |
| Rise Time | T_r | ----- | 250 | ----- | ps | RL=50Ω , CL=0pF 20%/80%*VDD |
| Fall Time | T_f | ----- | 250 | ----- | | |
| Duty Cycle | | 48 | ----- | 52 | % | Differential |
| Integrated Phase Jitter (J_{PH}) | | ----- | 0.25 | 2 | ps | 200kHz ~ 20MHz @156.25MHz |
| | | ----- | 0.38 | 2 | | 100kHz ~ 20MHz @156.25MHz |
| | | ----- | 1.70 | 2 | | 12kHz ~ 20MHz @156.25MHz |
| Period Jitter RMS (J_{PER}) | | ----- | 2.5 | ----- | ps | |

Key Electrical Specifications – LVDS

| Parameters | | Minimum | Typical | Maximum | Units | Notes |
|--|-------|---------|---------|---------|-------|--------------------------------|
| Supply Current (I_{dd}) | | ----- | 29 | 32 | mA | RL=100Ω |
| Output Offset Voltage (V_{OS}) | | 1.125 | ----- | 1.4 | V | RL=100Ω differential |
| Delta Offset Voltage (ΔV_{OS}) | | ----- | ----- | 50 | mV | |
| Peak to Peak Output Swing (V_{pp}) | | ----- | 350 | ----- | mV | Single ended |
| Rise Time | T_r | ----- | 200 | ----- | ps | RL=50Ω , CL=2pF 20%/80%*VDD |
| Fall Time | T_f | ----- | 200 | ----- | | |
| Duty Cycle | | 48 | ----- | 52 | % | Differential |
| Integrated Phase Jitter (J_{PH}) | | ----- | 0.28 | 2 | ps | 200kHz ~ 20MHz @156.25MHz |
| | | ----- | 0.40 | 2 | | 100kHz ~ 20MHz @156.25MHz |
| | | ----- | 1.70 | 2 | | 12kHz ~ 20MHz @156.25MHz |
| Period Jitter RMS (J_{PER}) | | ----- | 2.5 | ----- | ps | |

Key Electrical Specifications – HCSL

| Parameters | | Minimum | Typical | Maximum | Units | Notes |
|--|----------|---------|---------|---------|-------|--------------------------------|
| Supply Current (I_{dd}) | | ----- | 40 | 42 | mA | RL=50Ω |
| Output Logic Level | V_{OH} | 0.725 | ----- | ----- | V | RL=50Ω |
| | V_{OL} | ----- | ----- | 0.1 | V | |
| Peak to Peak Output Swing (V_{pp}) | | ----- | 750 | ----- | mV | Single ended |
| Rise Time | T_r | 200 | ----- | 400 | ps | RL=50Ω , CL=2pF 20%/80%*VDD |
| Fall Time | T_f | 200 | ----- | 400 | | |
| Duty Cycle | | 48 | ----- | 52 | % | Differential |
| Integrated Phase Jitter (J_{PH}) | | ----- | 0.25 | 2 | ps | 200kHz ~ 20MHz @156.25MHz |
| | | ----- | 0.37 | 2 | | 100kHz ~ 20MHz @156.25MHz |
| | | ----- | 1.70 | 2 | | 12kHz ~ 20MHz @156.25MHz |
| Period Jitter RMS (J_{PER}) | | ----- | 2.5 | ----- | ps | |

ABRACON IS
ISO 9001:2008
CERTIFIED



ABRACON
CORPORATION

Visit www.abracon.com for Terms & Conditions of Sale
30332 Esperanza, Rancho Santa Margarita, California 92688
tel 949-546-8000 | fax 949-546-8001 | www.abracon.com

Revised: 08.27.12

PERFORMANCE PLASTIC PACKAGE ULTRA MINIATURE PURE SILICON™ CLOCK OSCILLATORS

ASDMP



2.5 x 2.0 x 0.85 mm

ASDMP Series



Absolute Maximum Ratings

| Item | Minimum | Maximum | Unit | Condition |
|-----------------|---------|----------------------|------|-----------|
| Supply Voltage | -0.3 | +4.0 | V | |
| Input Voltage | -0.3 | V _{dd} +0.3 | V | |
| Junction Temp. | ----- | +150 | °C | |
| Storage Temp. | -55 | +150 | °C | |
| Soldering Temp. | ----- | +260 | °C | 40sec max |
| ESD | | | V | |
| HBM | | 4,000 | | |
| MM | | 400 | | |
| CDM | | 1,500 | | |

PART IDENTIFICATIONS:

Programmed Orders (Quantity > 1,000pcs)

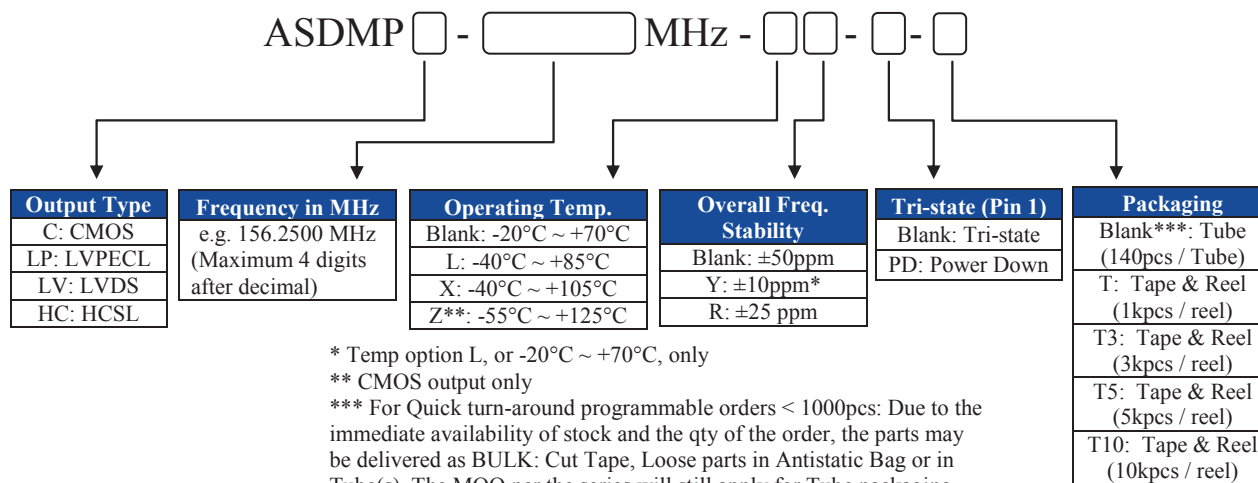

4.0.2 Un-Programmed Orders

Blank un-programmed oscillators and our low cost portable programmer are available for quick turn engineering requirements. Please call ABRACON or visit MEMSpeed Pro II site <http://www.abracon.com/memspeedpro/MEMSpeedProFlyerII.pdf> for more information.

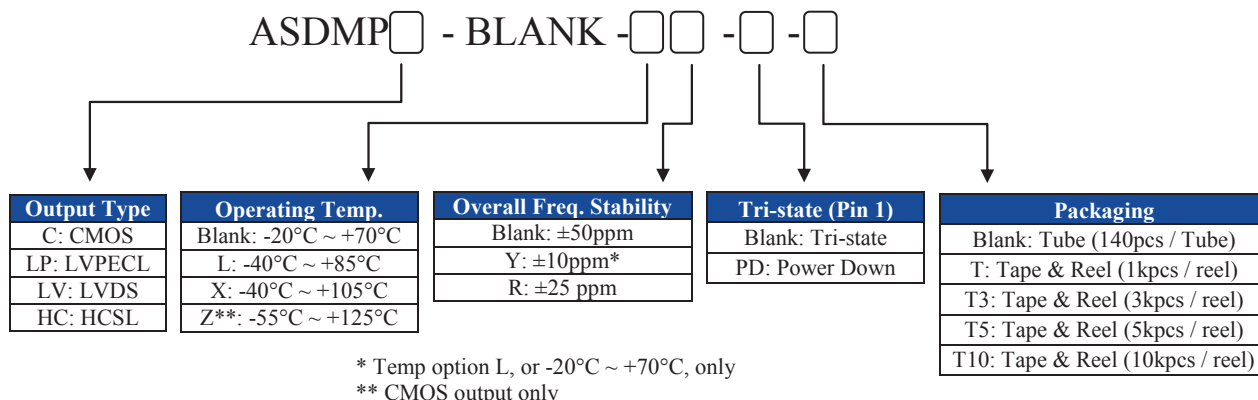

ABRACON IS
ISO 9001:2008
CERTIFIED



Visit www.abracon.com for Terms & Conditions of Sale
30332 Esperanza, Rancho Santa Margarita, California 92688
tel 949-546-8000 | fax 949-546-8001 | www.abracon.com

Revised: 08.27.12

PERFORMANCE PLASTIC PACKAGE ULTRA MINIATURE PURE SILICON™ CLOCK OSCILLATORS

ASDMP



2.5 x 2.0 x 0.85 mm

ASDMP Series



RoHS
Compliant

CMOS OUTPUT:

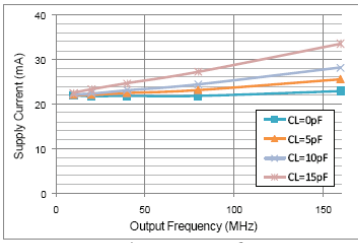

Supply current over freq

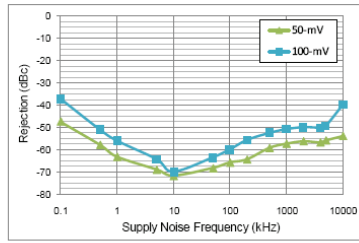

Power supply rejection ratio

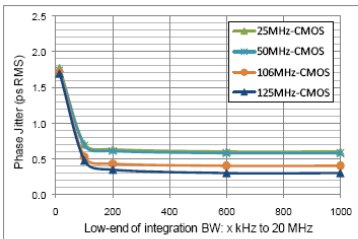

Phase jitter (integrated phase noise)

TEST CIRCUIT:

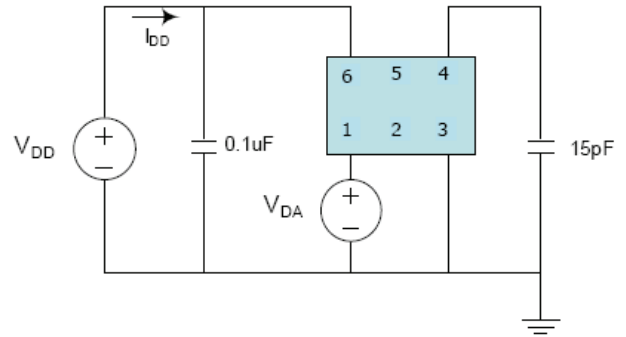

LVPECL OUTPUT:

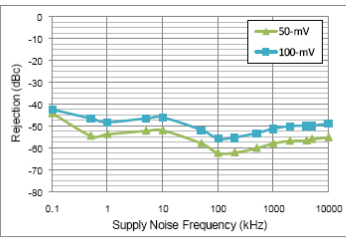

Power supply rejection ratio

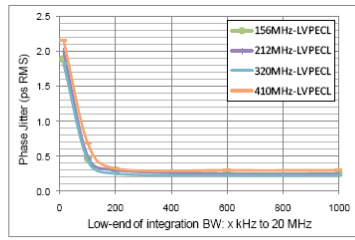

Phase jitter (integrated phase noise)

TEST CIRCUIT:

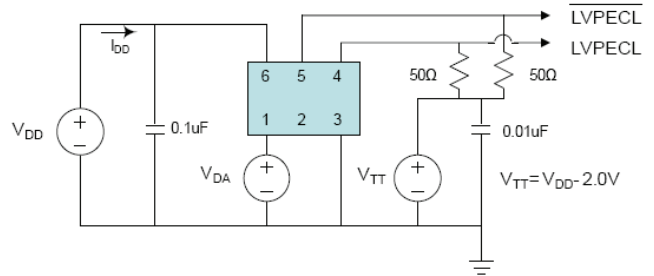

LVDS OUTPUT:

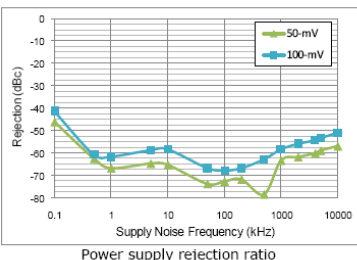

Power supply rejection ratio

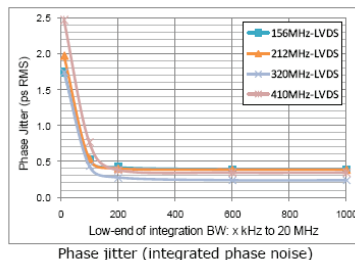

Phase jitter (integrated phase noise)

TEST CIRCUIT:

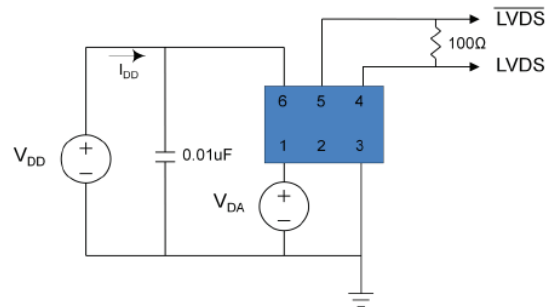

ABRACON IS
ISO 9001:2008
CERTIFIED



ABRACON
CORPORATION

Visit www.abracon.com for Terms & Conditions of Sale
30332 Esperanza, Rancho Santa Margarita, California 92688
tel 949-546-8000 | fax 949-546-8001 | www.abracon.com

Revised: 08.27.12

PERFORMANCE PLASTIC PACKAGE ULTRA MINIATURE PURE SILICON™ CLOCK OSCILLATORS

ASDMP



2.5 x 2.0 x 0.85 mm

ASDMP Series



HCSL OUTPUT:

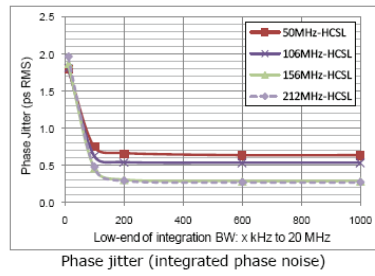
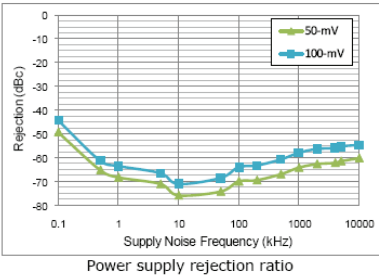

TEST CIRCUIT:

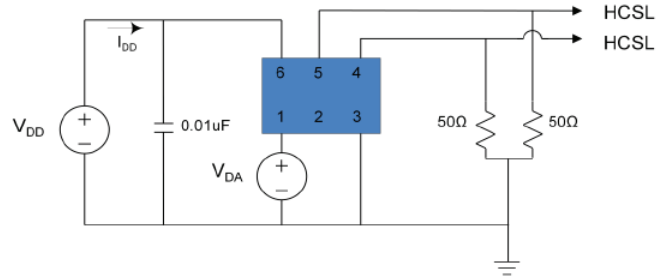

OUTLINE DRAWING:

2.5±0.05 [0.098±0.002]

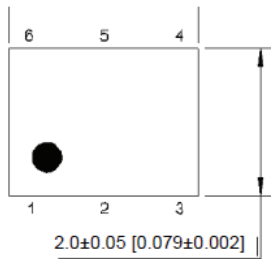

0.825 [.032]

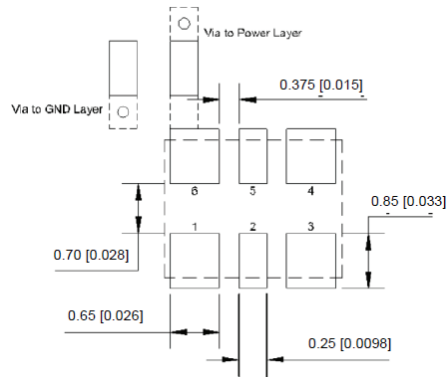
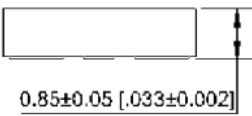
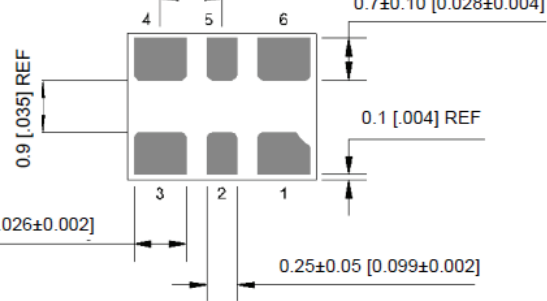

Recommended Land Pattern for LVPECL, LVDS, HCSL

| Pin # | Function |
|-------|--|
| 1 | Tri-state |
| 2 | NC |
| 3 | GND |
| 4 | Output |
| 5 | NC (CMOS) Output (LVPECL, LVDS, HCSL) |
| 6 | Vdd |

Note: Recommend using an approximately 0.01uF bypass capacitor between PIN 6 and 3.

Dimensions: mm (inches)

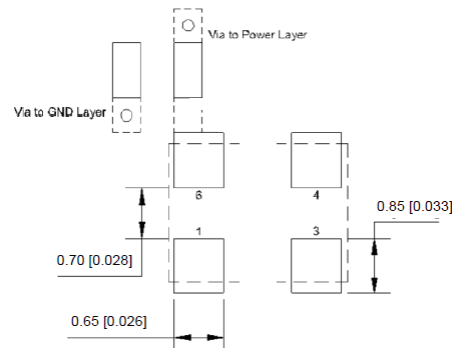

Recommended Land Pattern for CMOS

PERFORMANCE PLASTIC PACKAGE ULTRA MINIATURE PURE SILICON™ CLOCK OSCILLATORS

ASDMP



2.5 x 2.0 x 0.85 mm

ASDMP Series



REFLOW PROFILE:

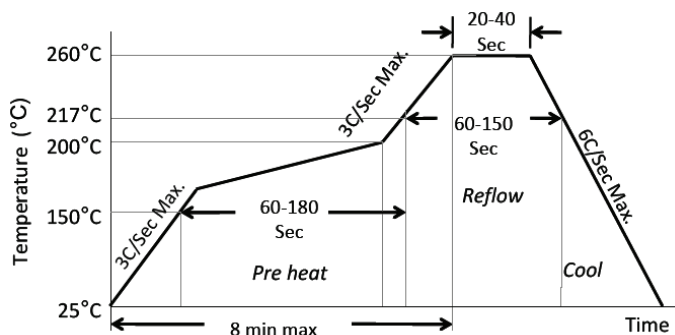

| | |
|-----------------------------------|--------------|
| Ramp-Up Rate (200°C to Peak Temp) | 3°C/Sec Max. |
| Preheat Time 150°C to 200°C | 60-180 Sec |
| Time maintained above 217°C | 60-150 Sec |
| Peak Temperature | 255-260°C |
| Time within 5°C of actual Peak | 20-40 Sec |
| Ramp-Down Rate | 6°C/Sec Max. |
| Time 25°C to Peak Temperature | 8 min Max. |

TAPE & REEL:

T= 1,000pcs/reel (D=180mm)
T3= 3,000pcs/reel (D=180mm)
T5= 5,000pcs/reel (D=330mm)
T10= 10,000pcs/reel (D=330mm)

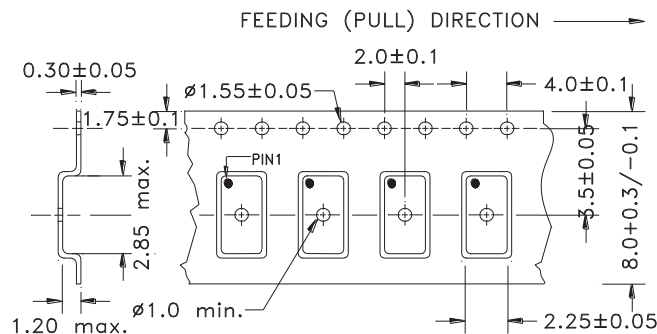

Tube: 140 pcs/tube

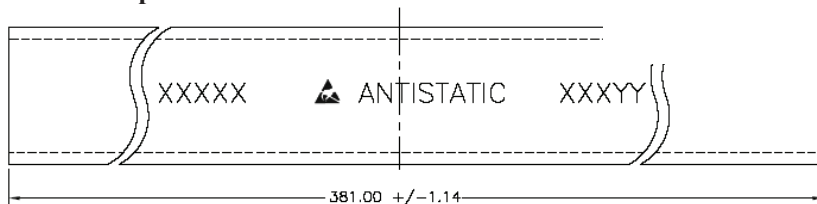

Unit orientation in tube:

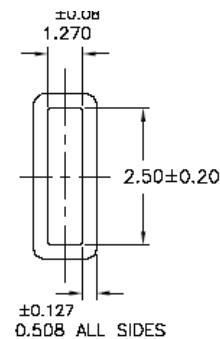
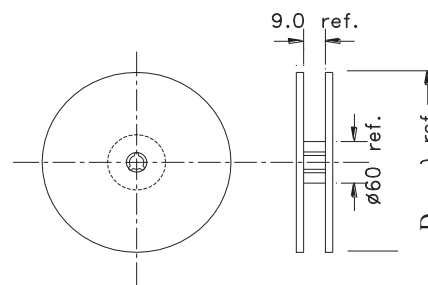

Dimensions: mm

ATTENTION: Abracon Corporation's products are COTS – Commercial-Off-The-Shelf products; suitable for Commercial, Industrial and, where designated, Automotive Applications. Abracon's products are not specifically designed for Military, Aviation, Aerospace, Life-dependant Medical applications or any application requiring high reliability where component failure could result in loss of life and/or property. For applications requiring high reliability and/or presenting an extreme operating environment, written consent and authorization from Abracon Corporation is required. Please contact Abracon Corporation for more information.

ABRACON IS
ISO 9001:2008
CERTIFIED



Visit www.abracon.com for Terms & Conditions of Sale
30332 Esperanza, Rancho Santa Margarita, California 92688
tel 949-546-8000 | fax 949-546-8001 | www.abracon.com

Revised: 08.27.12