

DETAILS

Product Number	CN13129_MIRELLA-50-W-PF
Family	Mirella
Type	RefPack
Color	metal
Diameter	49,9 mm
Height	24,8 mm
Style	round
Optic Material	
Holder Material	
Fastening	glue, screw
Status	production ready
ROHS Compliant	Yes
Date Updated	31/10/2016



OPTICAL PROPERTIES

LED	Viewing	Light	Efficiency	cd/lm	Connector
	Angle	Beam			
CLL01x	36 deg	Wide	90 %	1.800	-
CLL02x/CLU02x (LES10)	41 deg	Wide	90 %	1.800	-
CLU700/701	33 deg	Wide	88 %	1.900	-
MT-G	48 deg	Wide	90 %	1.400	-
MT-G2	46 deg	Wide	91 %	0.800	-
MK-R	30 deg	Wide	85 %	2.100	-
XHP70	39 deg	Wide	86 %	1.500	-
XHP50	33 deg	Wide	87 %	1.800	-
MHD-E/G	38 deg	Wide	89 %	1.500	-
COB 4W	38 deg	Wide	89 %	1.700	-
CXM-6	36 deg	Wide	85 %	1.800	-
CXM-7	38 deg	Wide	86 %	1.600	-
CXM-9	44 deg	Wide	88 %	1.300	-
Duris S10	38 deg	Wide	87 %	1.700	LEDiL: LEDiL
Soleriq S9	sim: 46	Wide	sim: 91 %	sim: 1.400	LEDiL: LEDiL
ZC4/6	42 deg	Wide	86 %	1.400	-
Mini Zenigata (GW6BM)	38 deg	Wide	88 %	1.500	-
SLE G5 LES6	35 deg	Wide	88 %	1.760	LEDiL: LEDiL
SLE G5 LES11	45 deg	Wide	87 %	1.320	LEDiL: LEDiL

Relative intensity of CN13129_MIRELLA-50-W-PF-(CLL010)

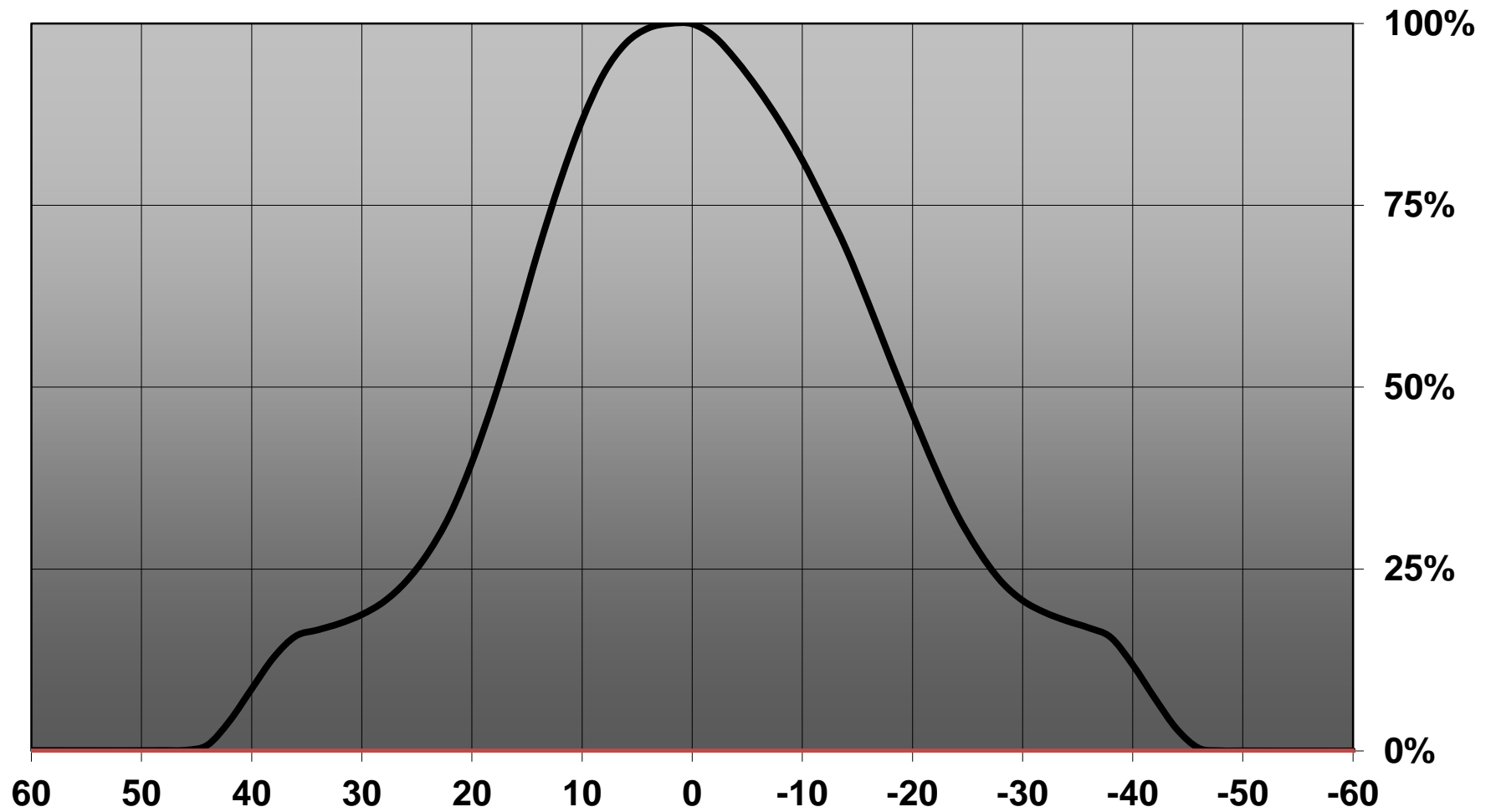

Relative intensity of CN13129_MIRELLA-50-W-PF-(CLL020)

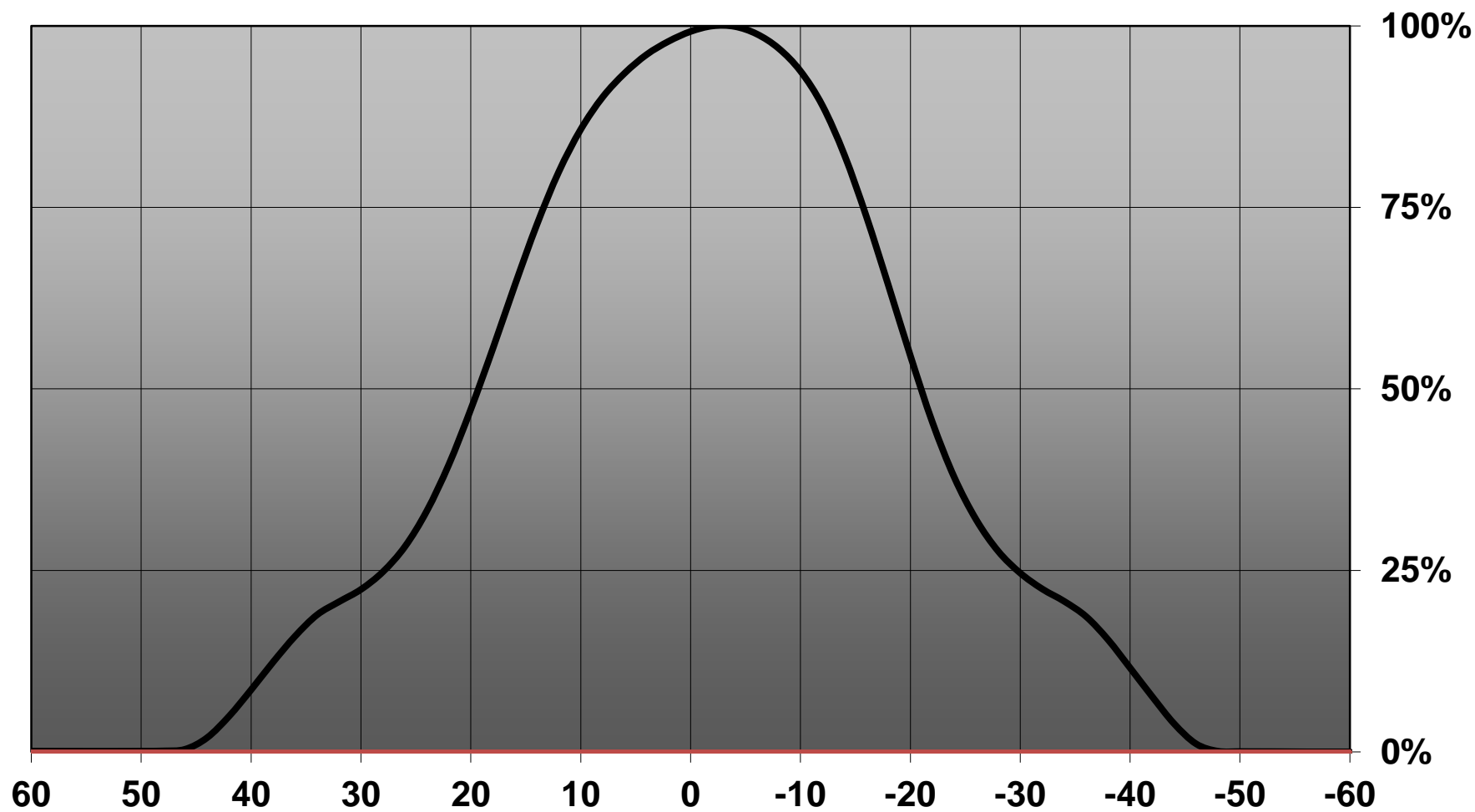

Relative intensity of CN13129_MIRELLA-50-W-PF-(MTG)

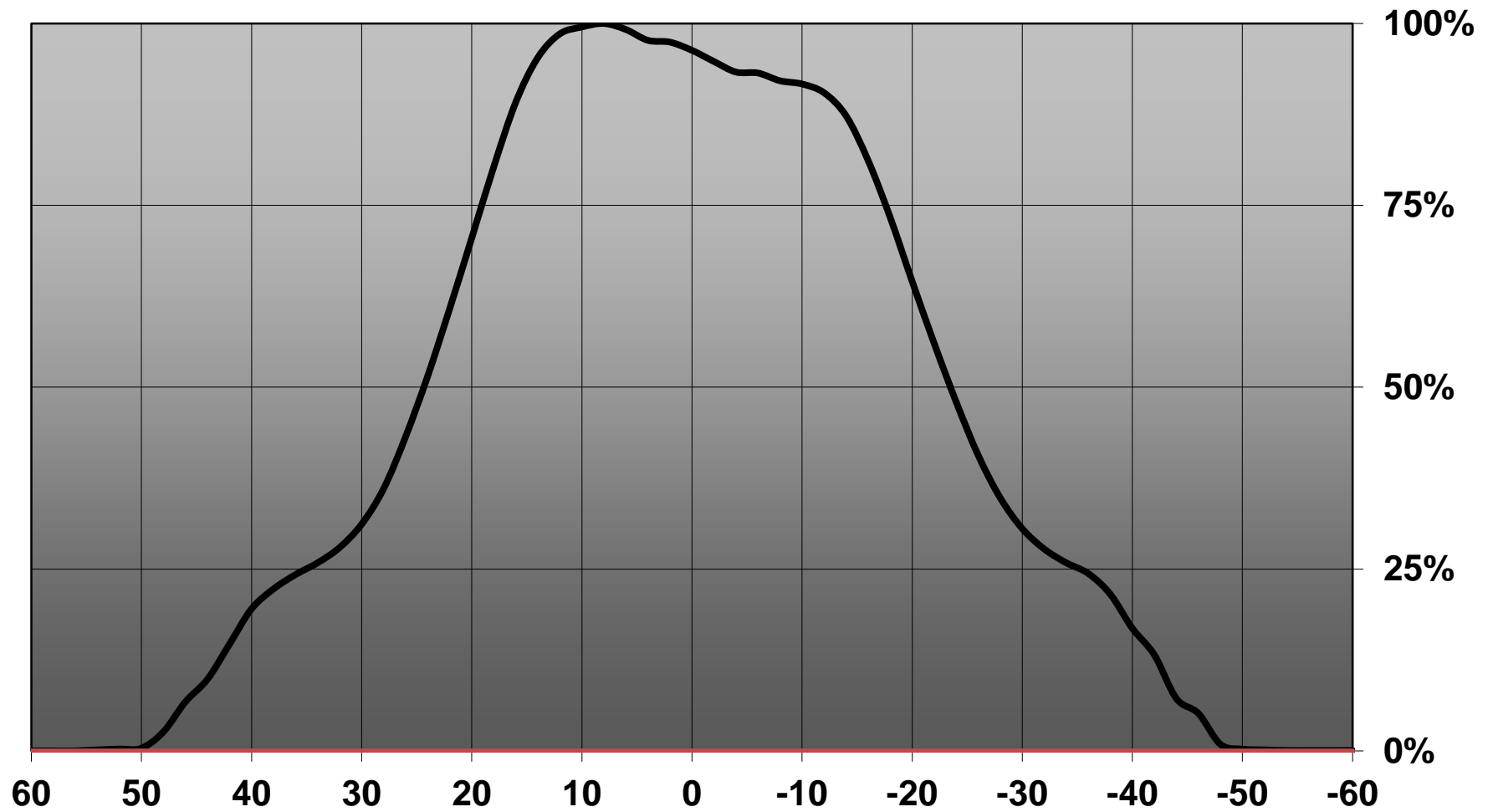

Relative intensity of CN13129_MIRELLA-50-W-PF-(MTG2)

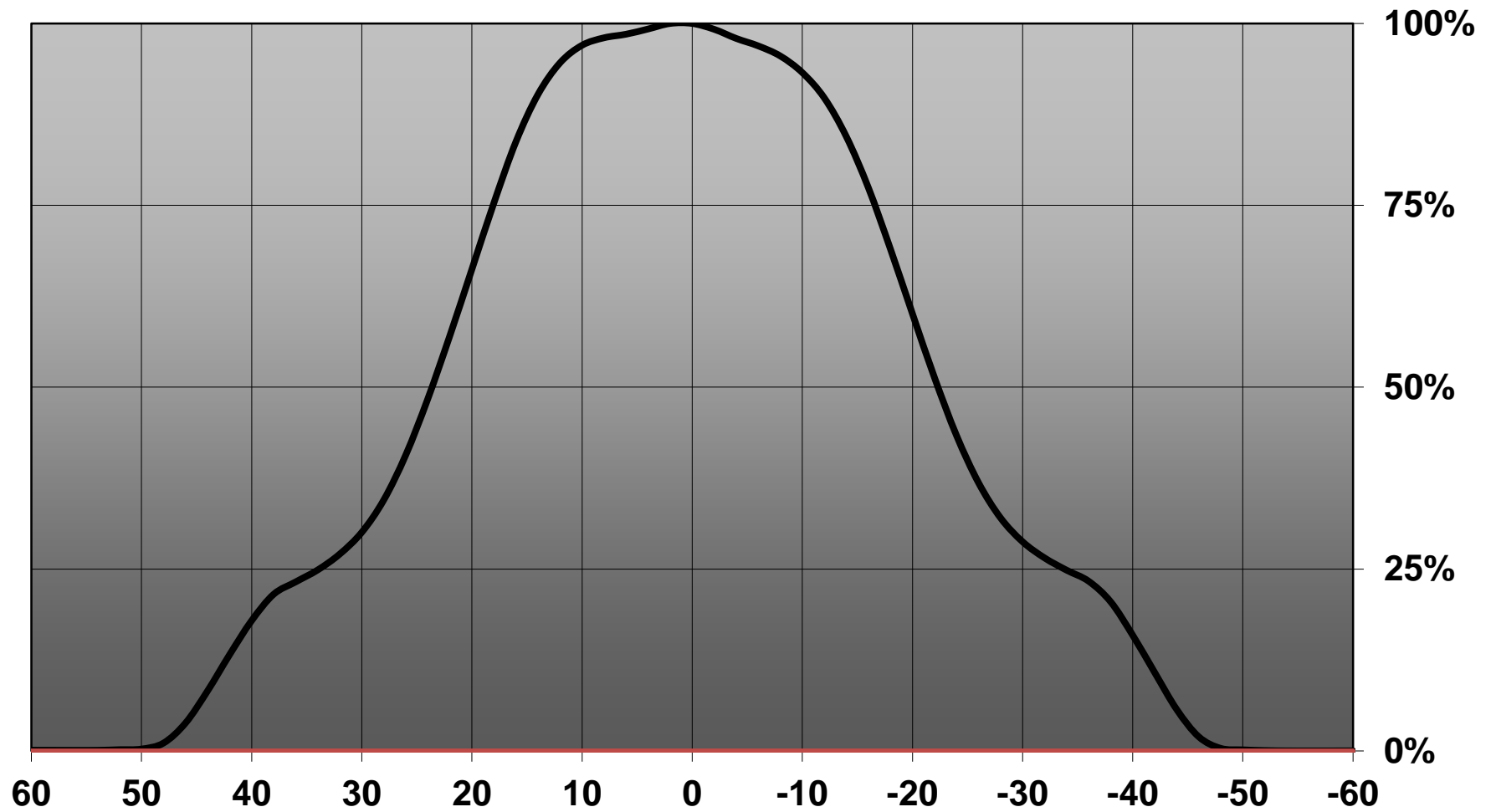

Relative intensity of Mirella-W-4WLG

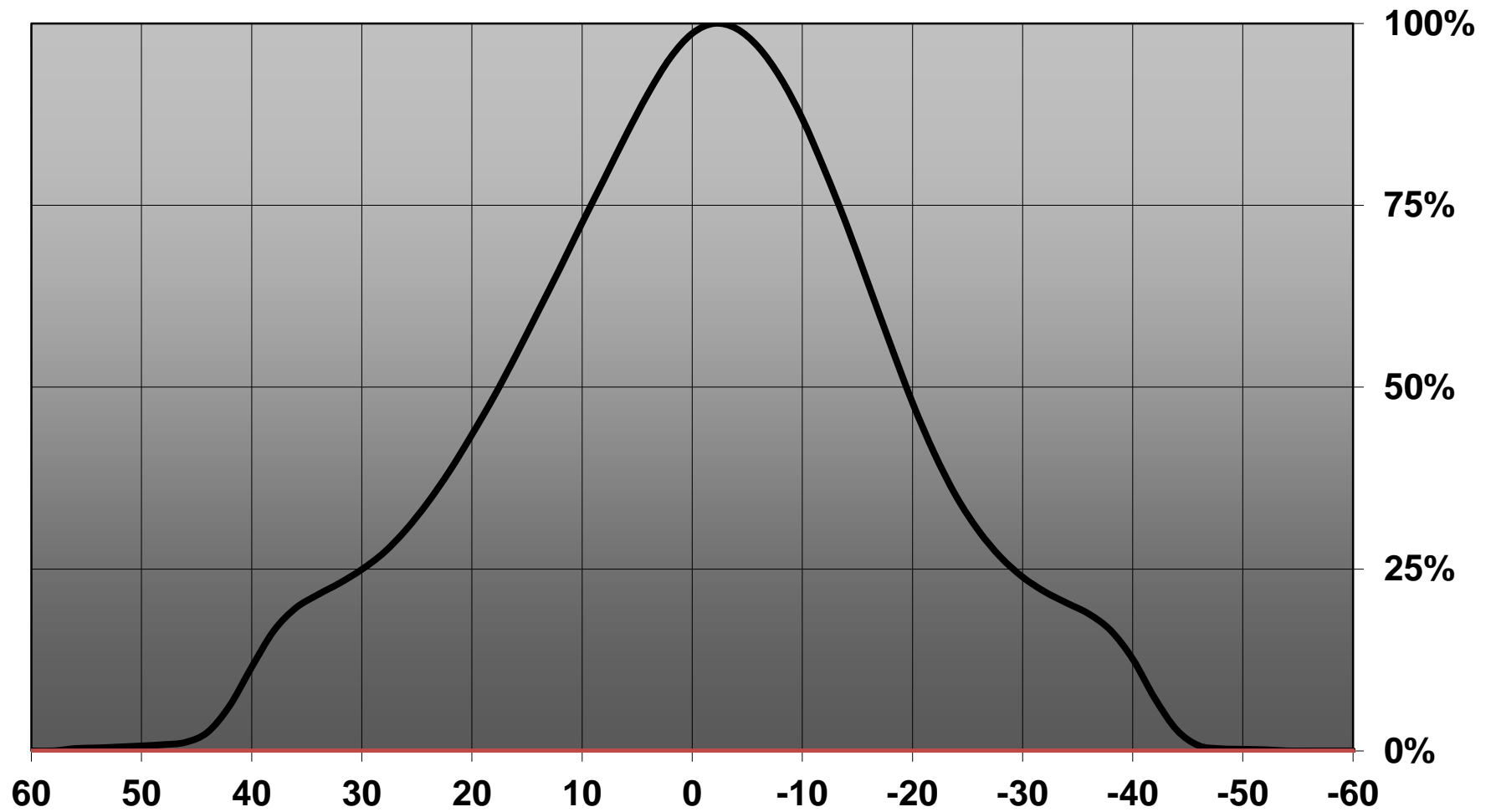

Relative intensity of CN13129_MIRELLA-50-W-PF_(Duris_S10)

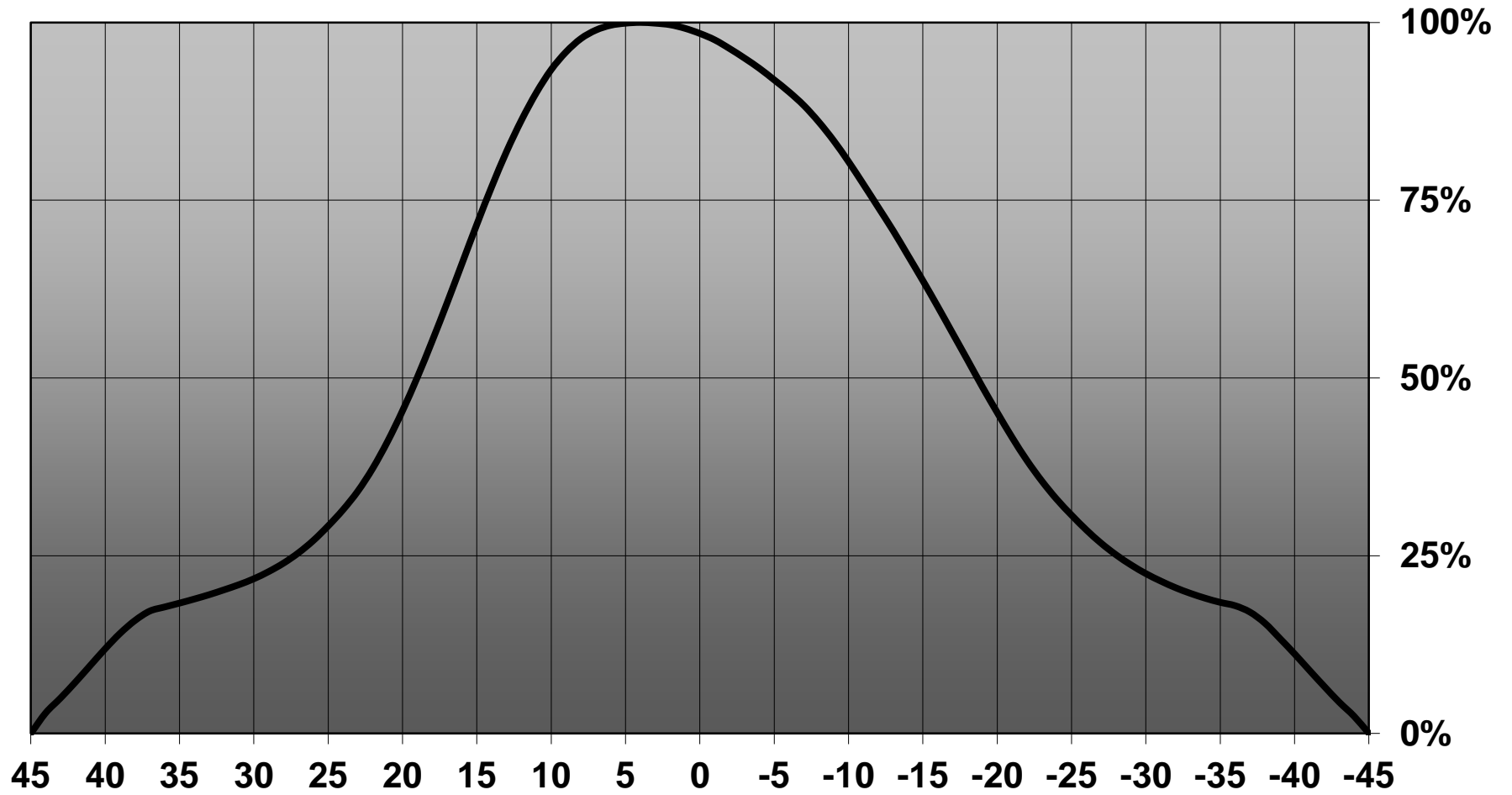

D

C

B

A

4

4

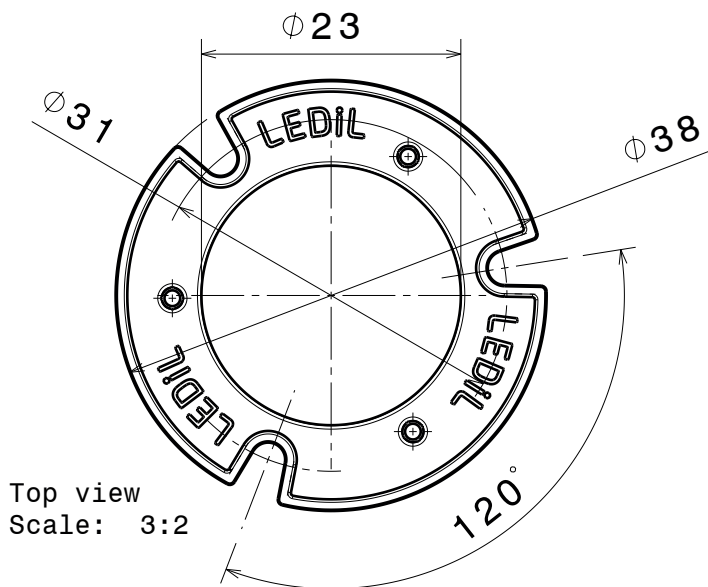

Top view
Scale: 3:2

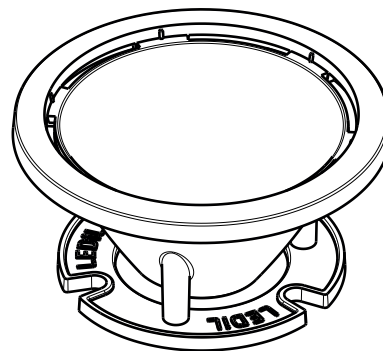

Isometric view

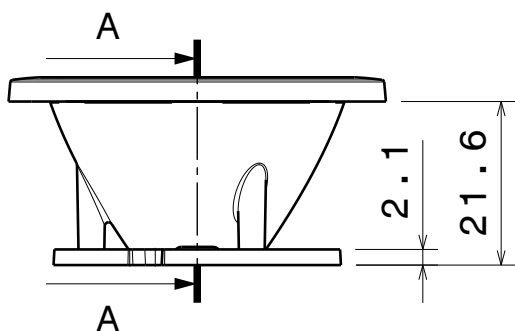

Front view

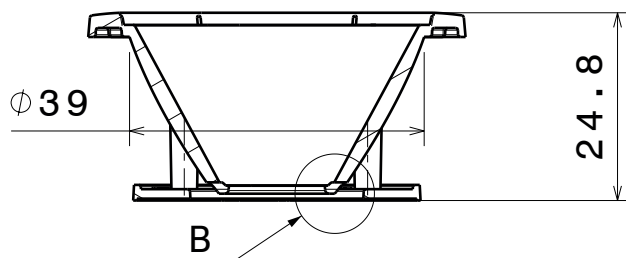

Section view A-A

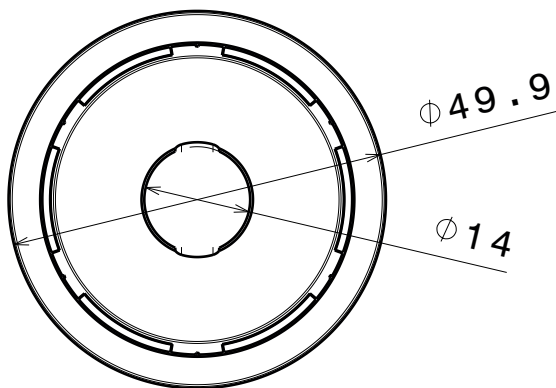

Top view

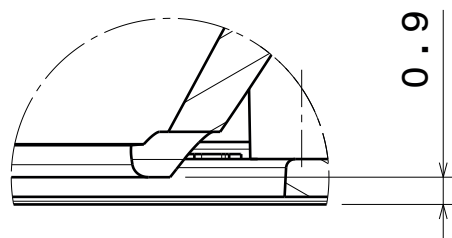

Detail B

NOTE: It is recommended to use glue like DELO-PUR 9895 for pin fastening.
[http://www.delo.de/fileadmin/datasheet/DELO-PUR_9895_\(TIDB-GB\).pdf](http://www.delo.de/fileadmin/datasheet/DELO-PUR_9895_(TIDB-GB).pdf)

This drawing is our property.
It can't be reproduced
or communicated without
our written agreement.

LEDIL

Ledil Oy
Salorankatu 10
FIN 24240 SALO
Finland

DRAWING TITLE

Mechanical drawing

DRAWN BY

as

DATE

28.8.2012

MIRELLA-PF

CHECKED BY

VS

DATE

28.8.2012

SIZE

A4

REV

001

DESIGNED BY

as

DATE

SCALE

1:1

WEIGHT

-

SHEET

1/1

D

A

1

1

Luminaire: LEDiL Oy CN13129_MIRELLA-50-W-PF_(CLU700)

Lamps: 1 x Citizen_CLU700_C13083_PF-SOCKET_394.785lm@100mA_P=2.92999W_I=0.1044A

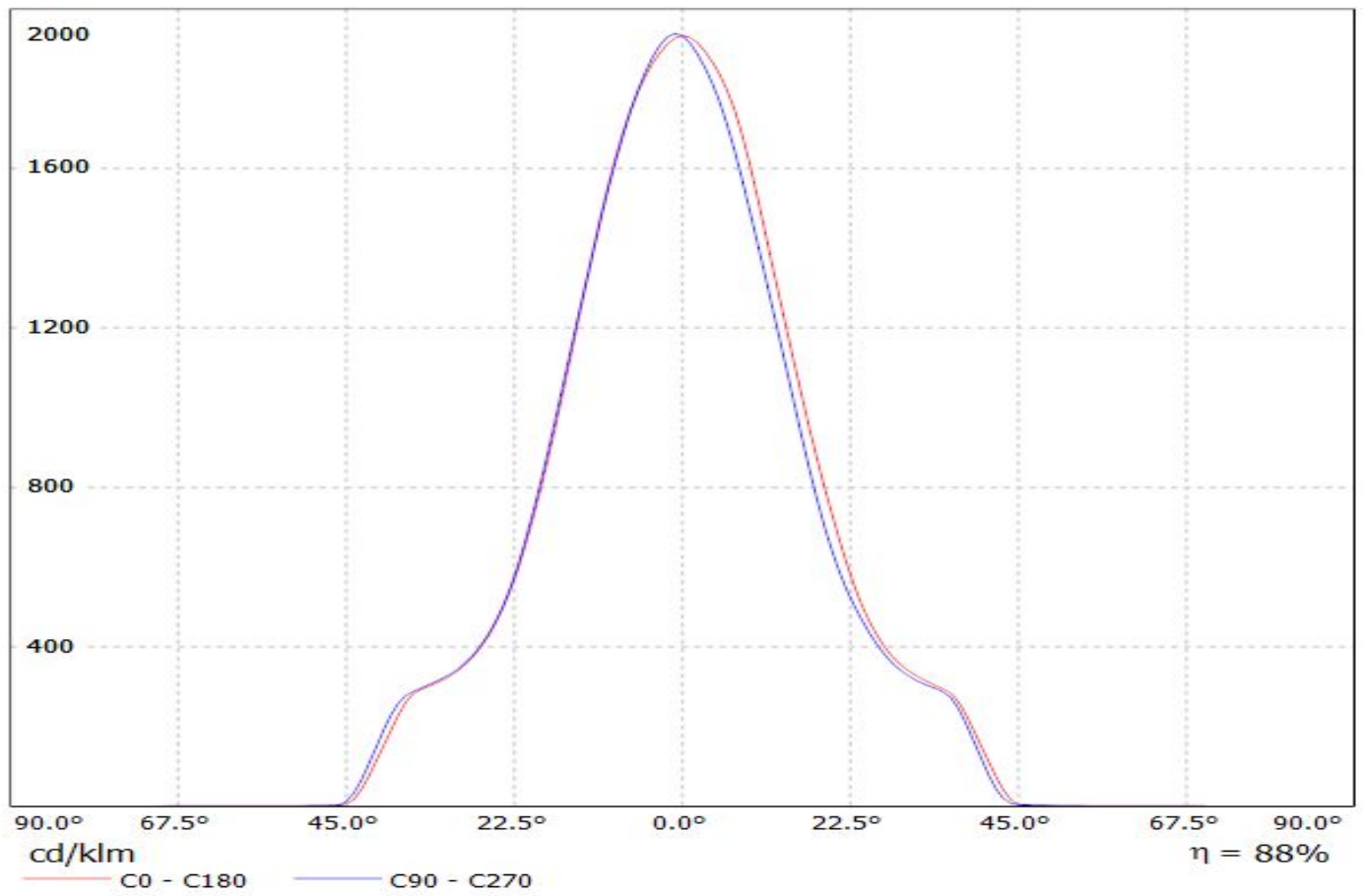

Luminaire: LEDiL Oy CN13129_MIRELLA-50-W-PF_(MK-R) Eff.85.3%
Lamps: 1 x CREE_MK-R_358.348lm@250mA_P=2.84311W_I=249.9mA

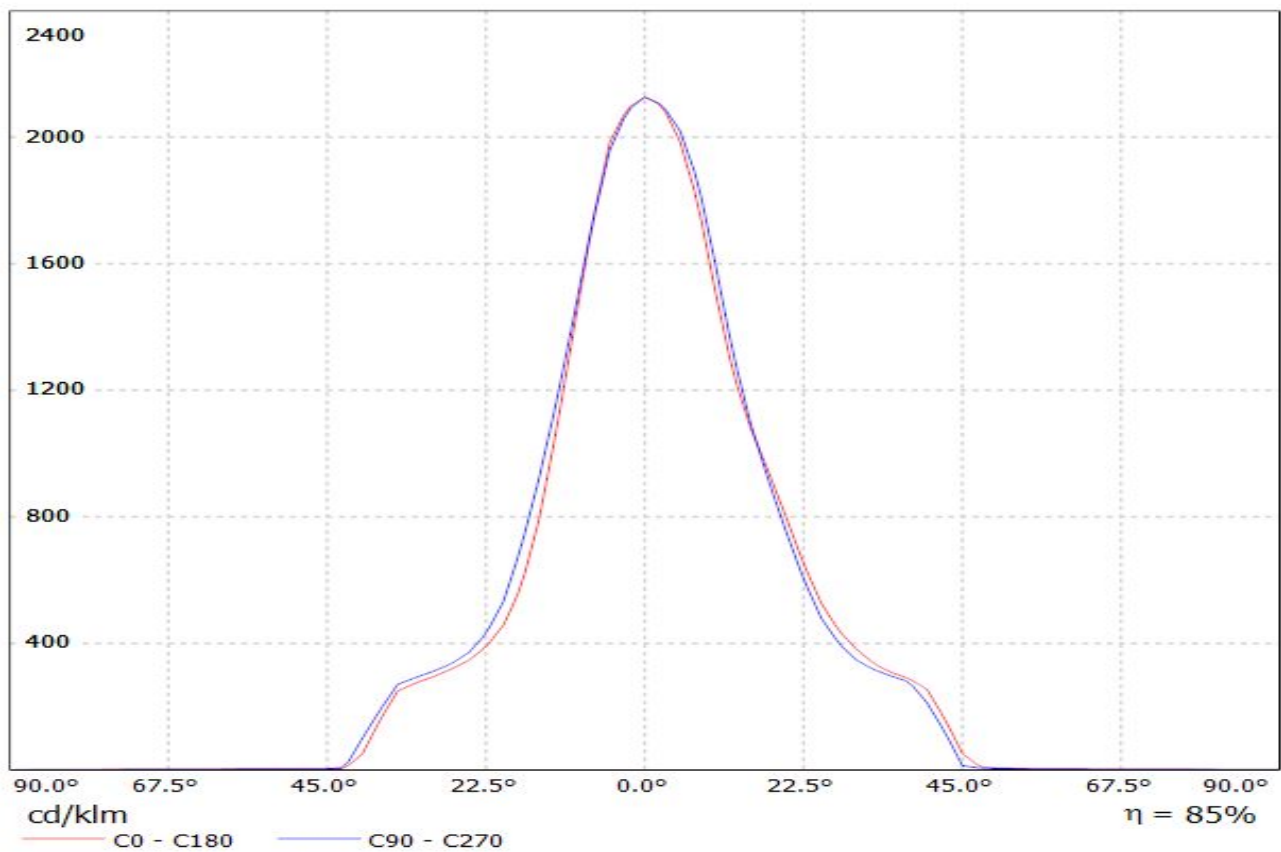

Luminaire: LEDiL Oy CN13129_MIRELLA-50-W-PF_(Cree_XHP70)
Lamps: 1 x Cree_XHP70_261.339lm@250mA_P=1.3827W_I=0.2499A

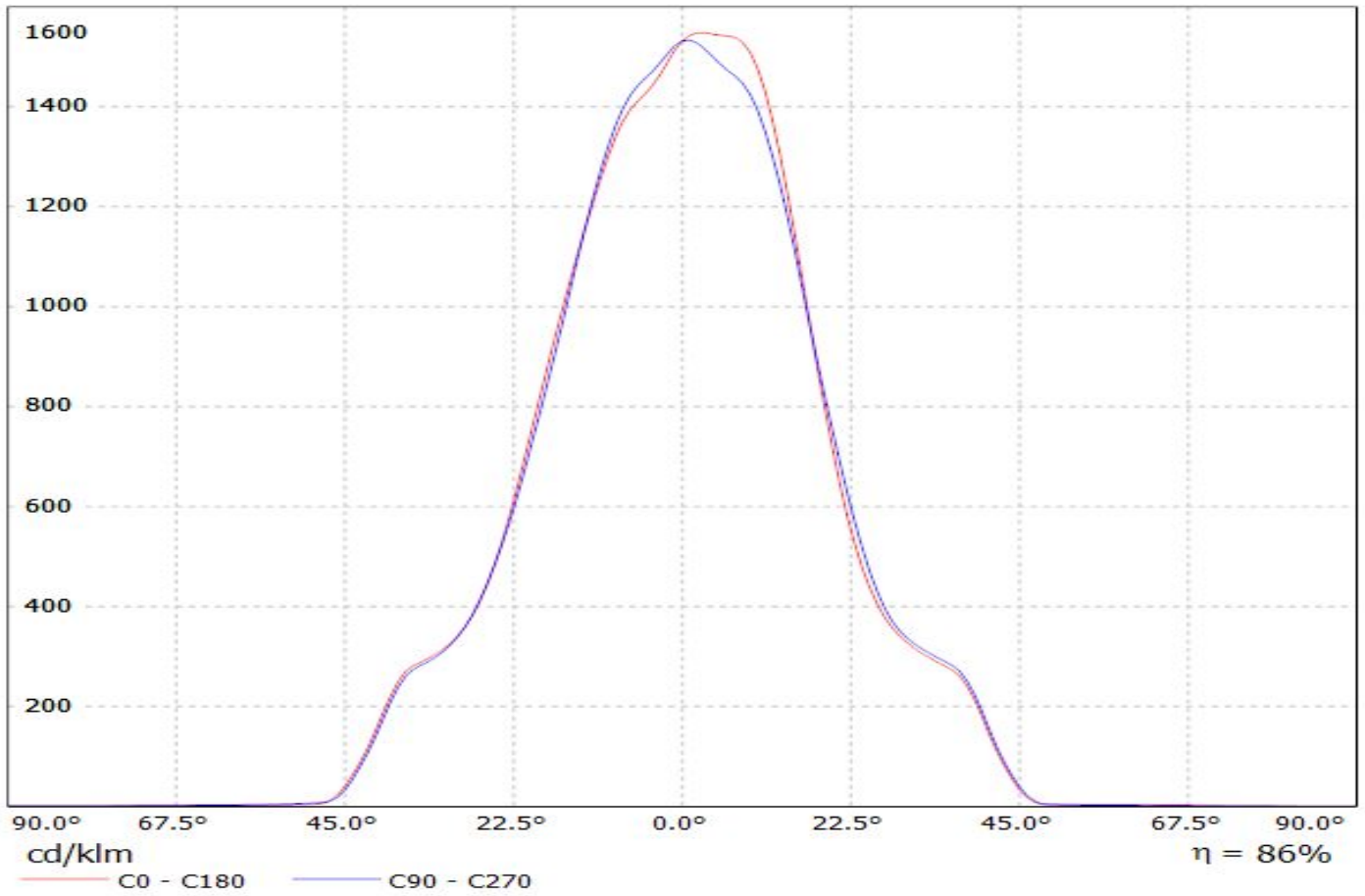

Luminaire: LEDiL Oy CN13129_MIRELLA-50-W-PF_(Cree_XHP50_WW)
Lamps: 1 x Cree_XHP50_WW_196.271lm@250mA_P=1.39897W_I=0.2499A

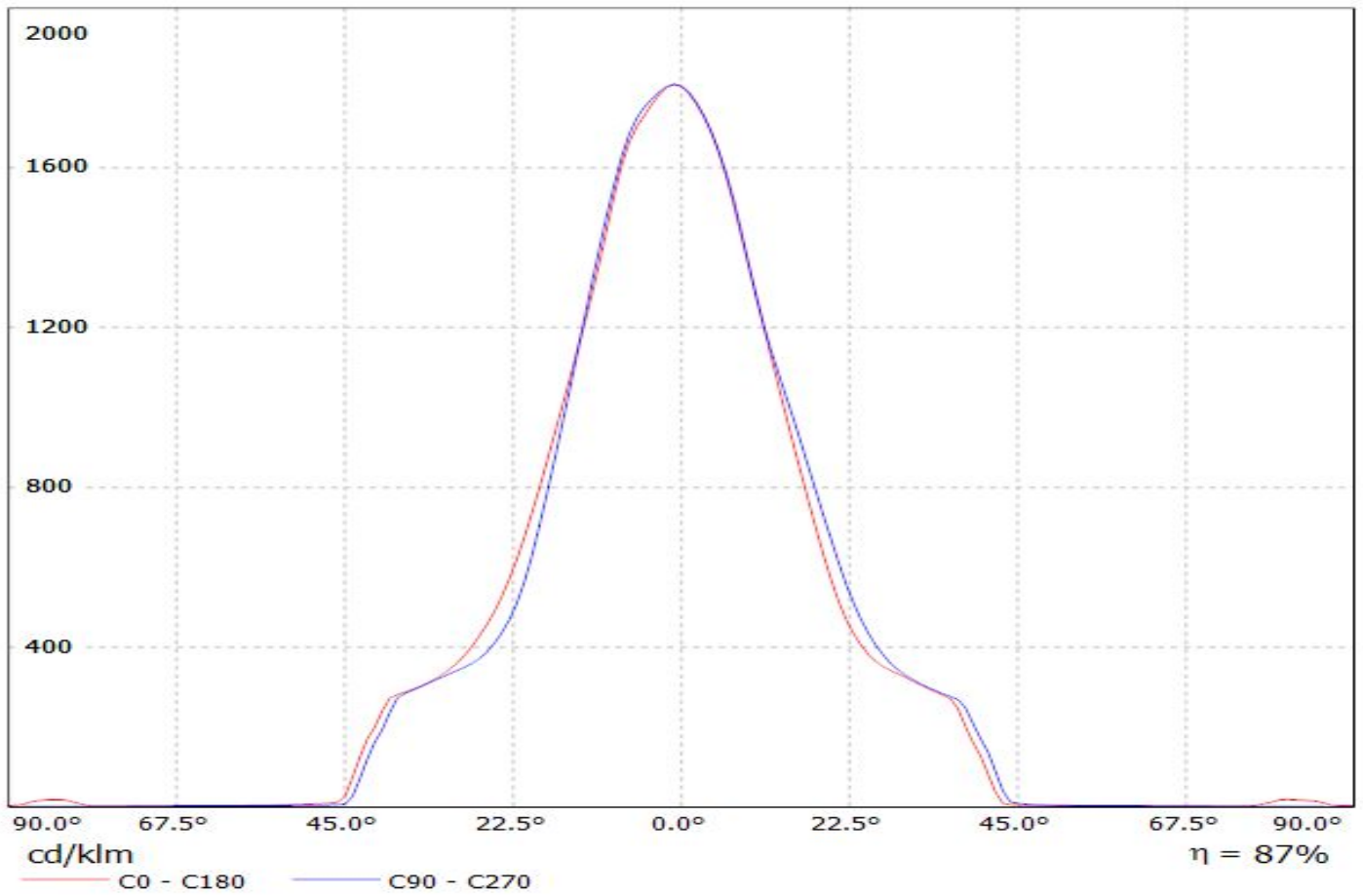

Luminaire: Ledil CN13129_MIRELLA-50-W-PF_(MHD-G)
Lamps: 1 x Cree MHD-G_530.44lm@100mA_P=3.0W_I=0.100A

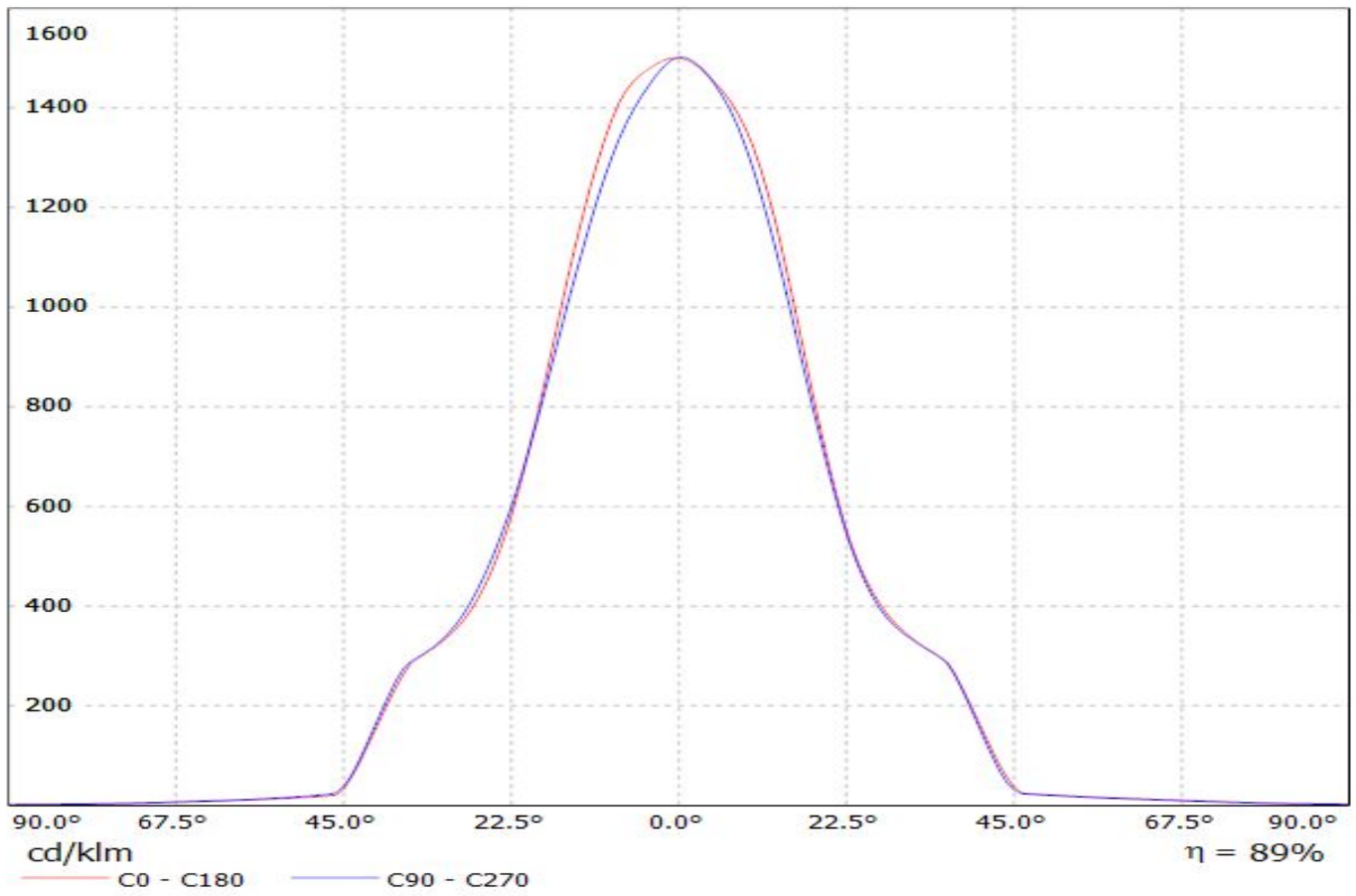

Luminaire: LEDil Oy CN13129_MIRELLA-50-W-PF_(CXM-6) Efficiency=85%
Lamps: 1 x Luminus XNOVA CXM-6 (437lm @ 120mA) CCT=3200K P=4.2W I=120mA

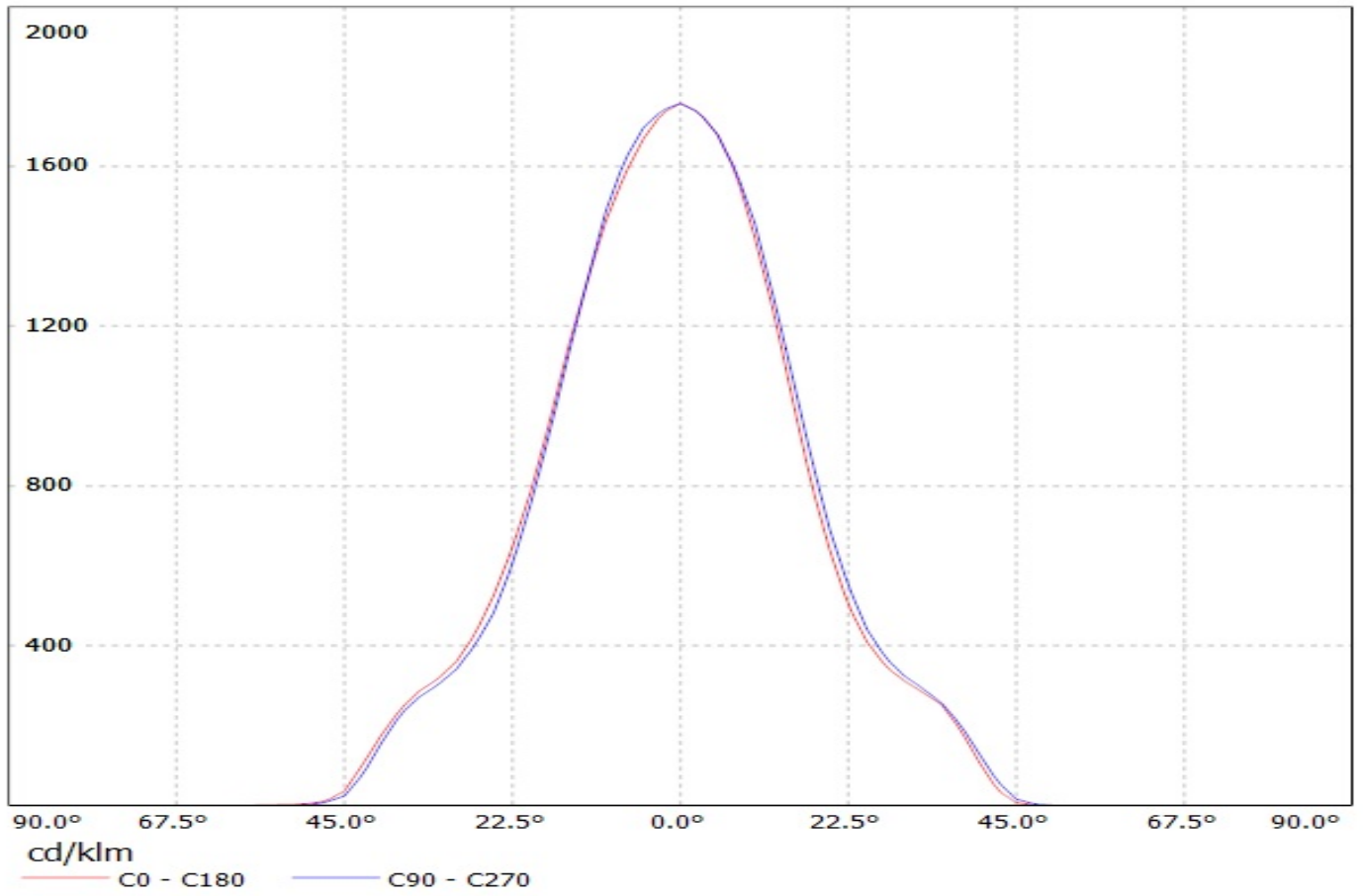

Luminaire: LEDil Oy CN13129_MIRELLA-50-W-PF_(CXM-7) Efficiency=86%
Lamps: 1 x Luminus XNOVA CXM-7 (522lm @ 160mA) CCT=2900K P=5.6W I=160mA

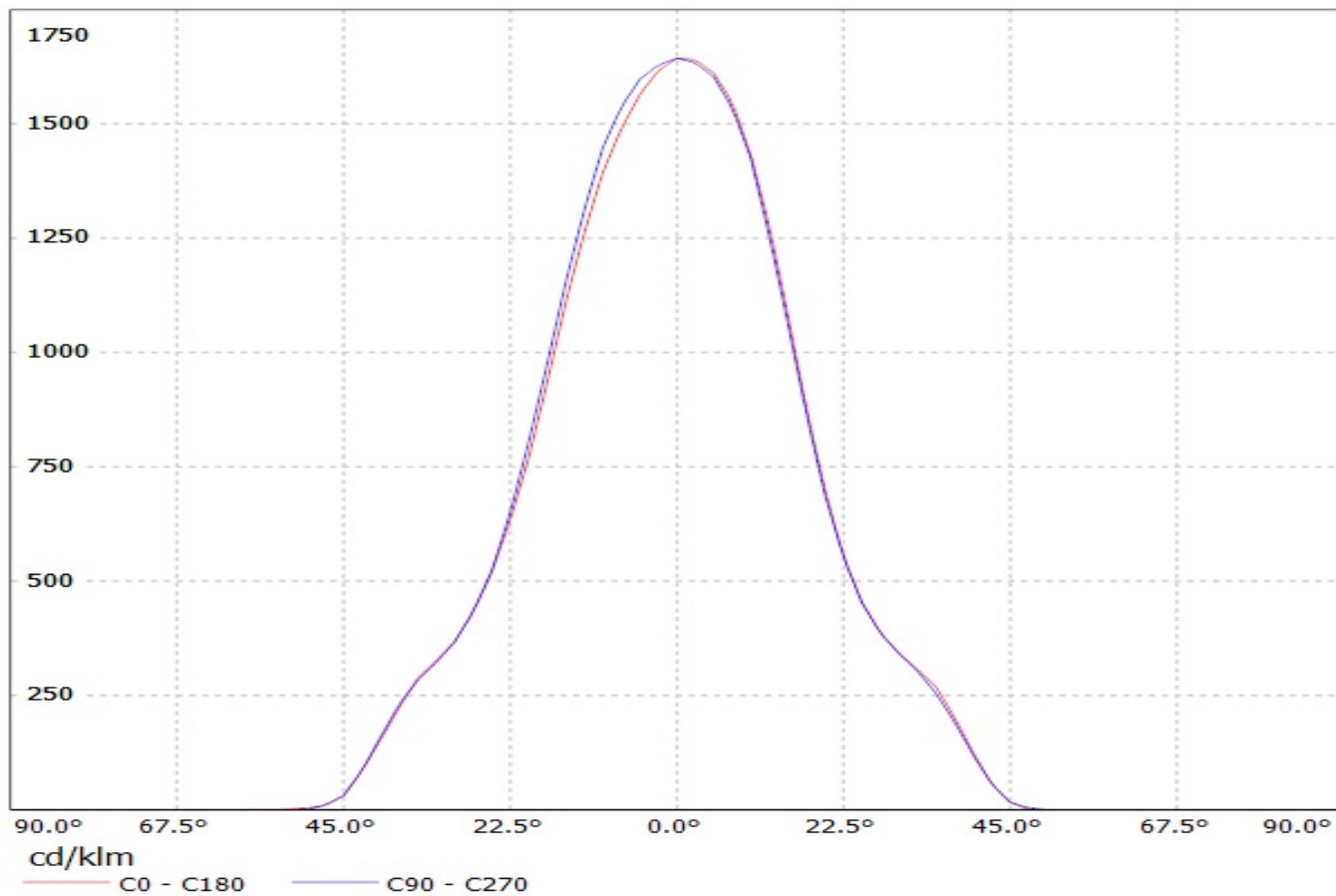

Luminaire: LEDiL Oy CN13129_MIRELLA-50-W-PF_(CXM-9)

Lamps: 1 x Luminus_XNOVA_CXM-9_(AA00)_974.297lm@240mA_P=8.2836W_I=240mA

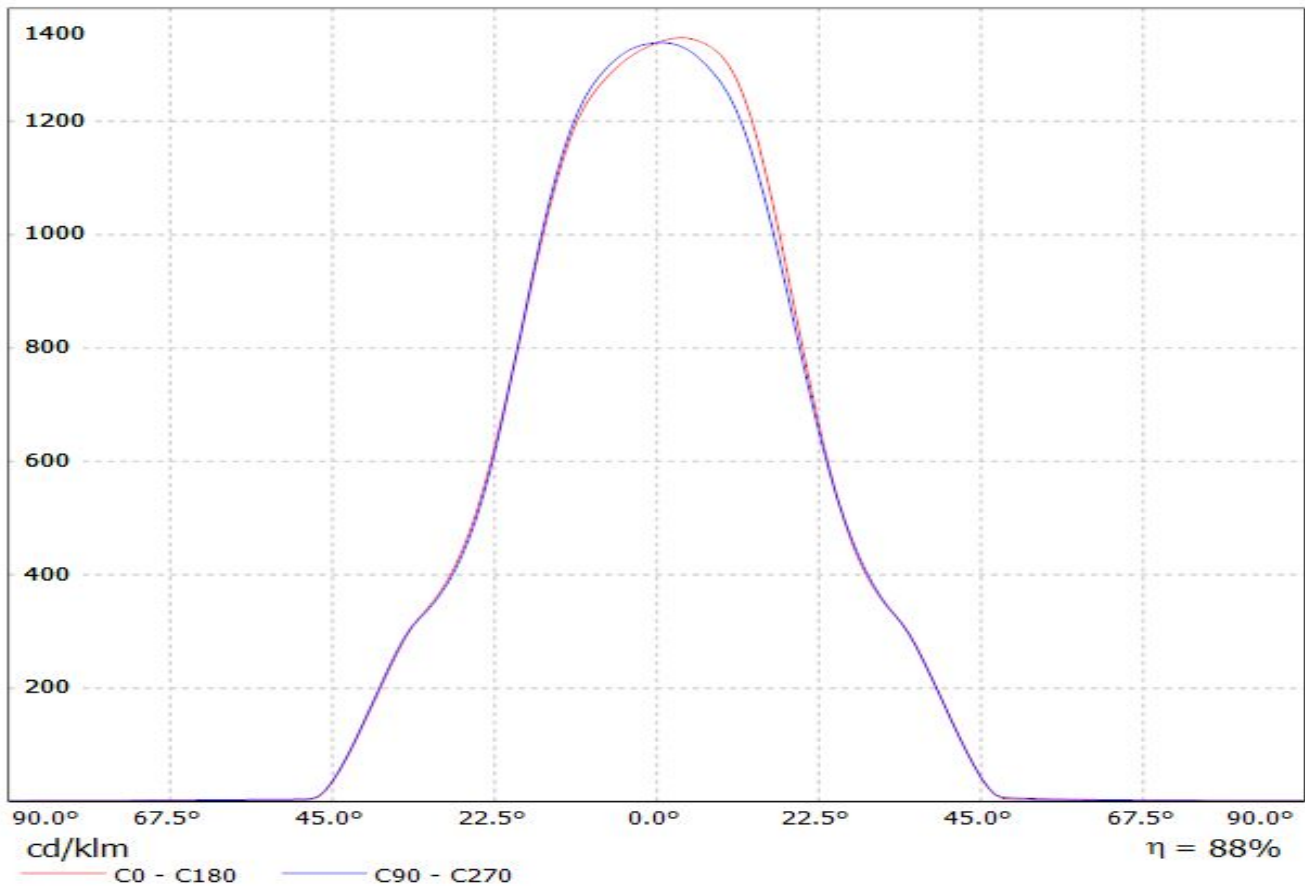

Luminaire: Ledil Oy CN13129_MIRELLA-50-W-PF_(Soleriq_S9)_SIMULATED
Lamps: 1 x Osram Soleriq S9 (GW KAJFB3.EM)

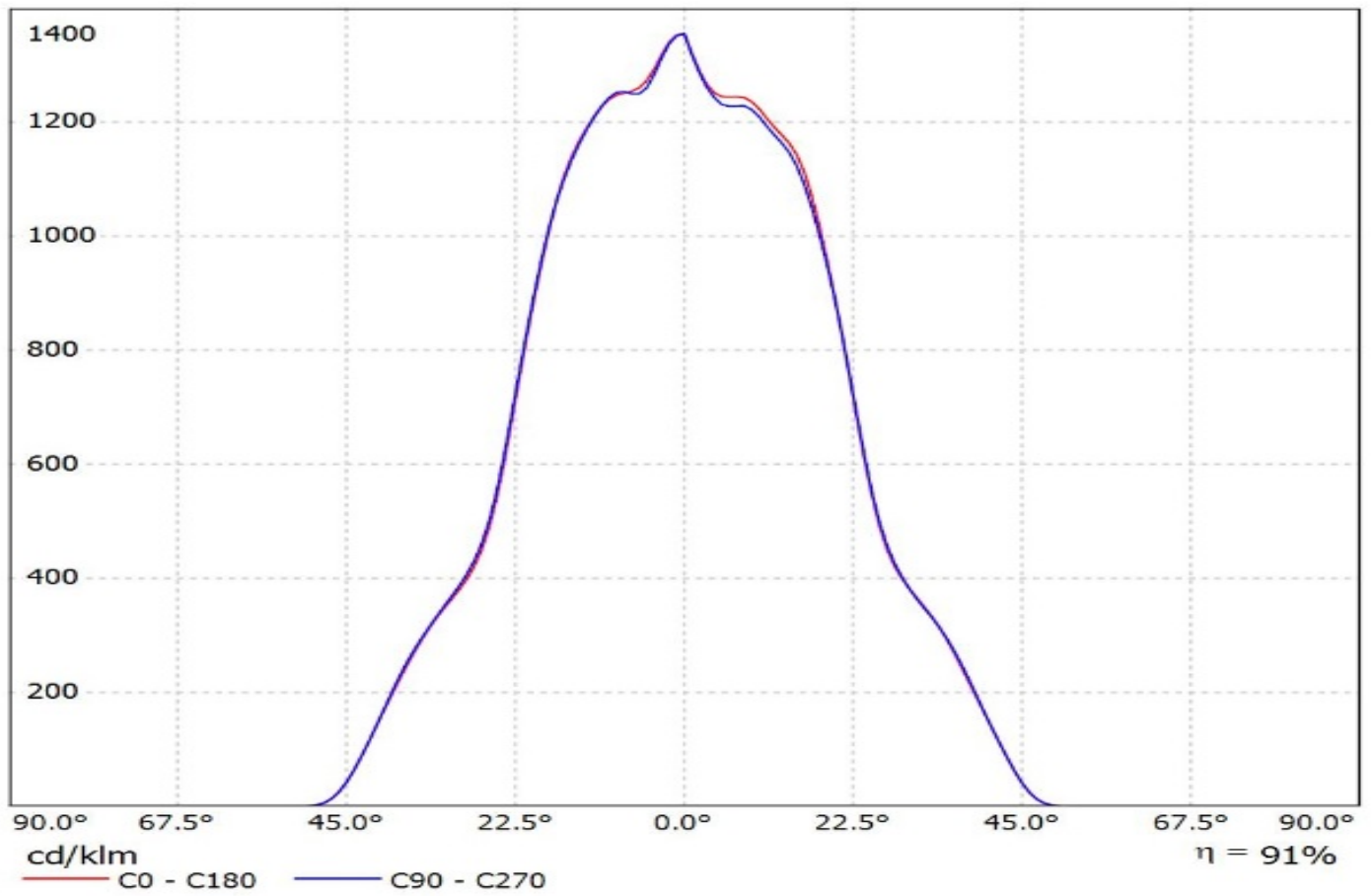

Luminaire: LEDil Oy CN13129_MIRELLA-50-W-PF_(ZC6) Efficiency=86%
Lamps: 1 x Seoul ZC6 (SDW81F1C) 422lm @ 100mA CCT=3100K P=3.4W I=100mA

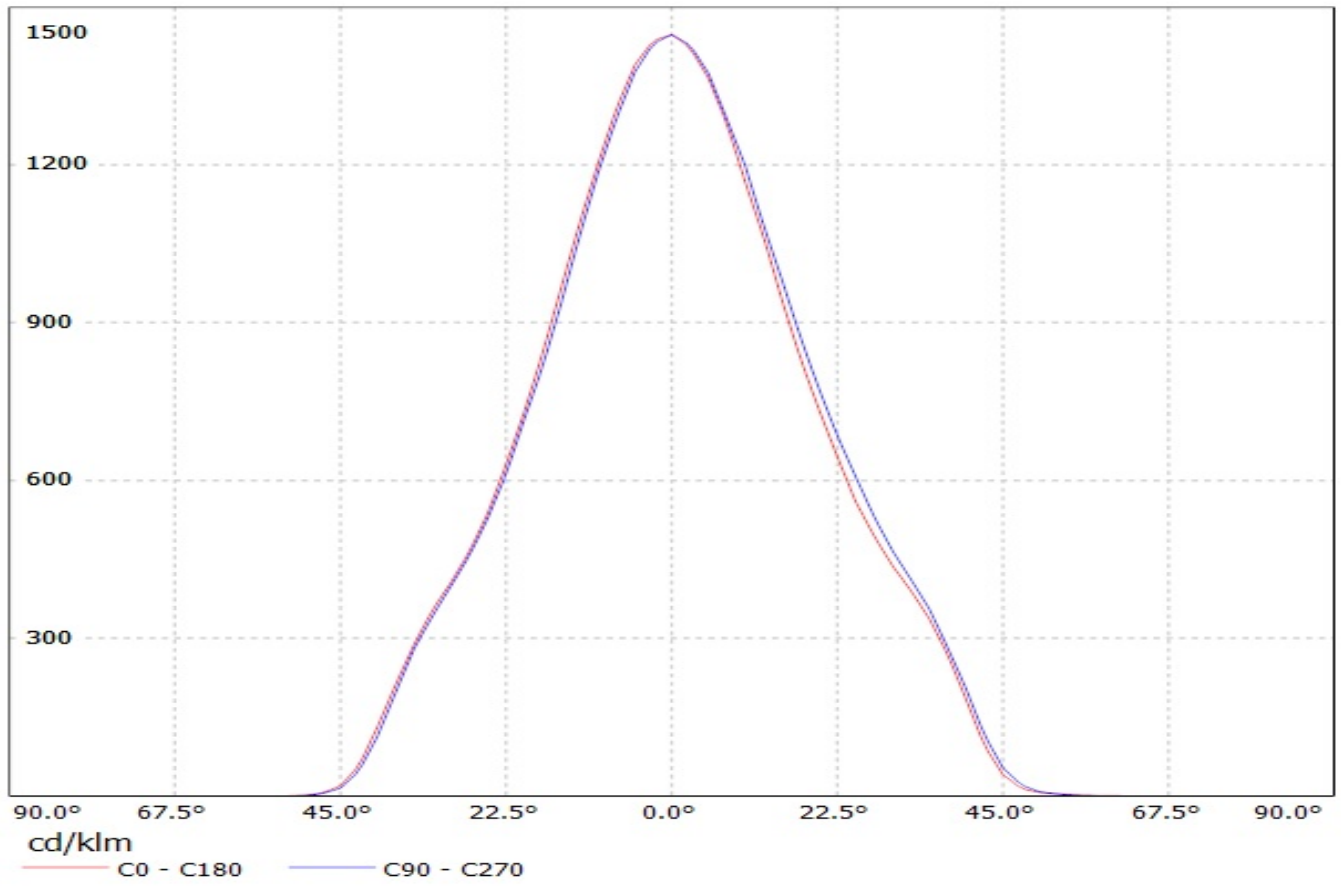

Luminaire: LEDiL Oy CN13129_MIRELLA-50-W-PF_(Mini_Zenigata_GW6BM) Eff.87.7%
Lamps: 1 x Mini_Zenigata_GW6BM (803.772lm@250mA)

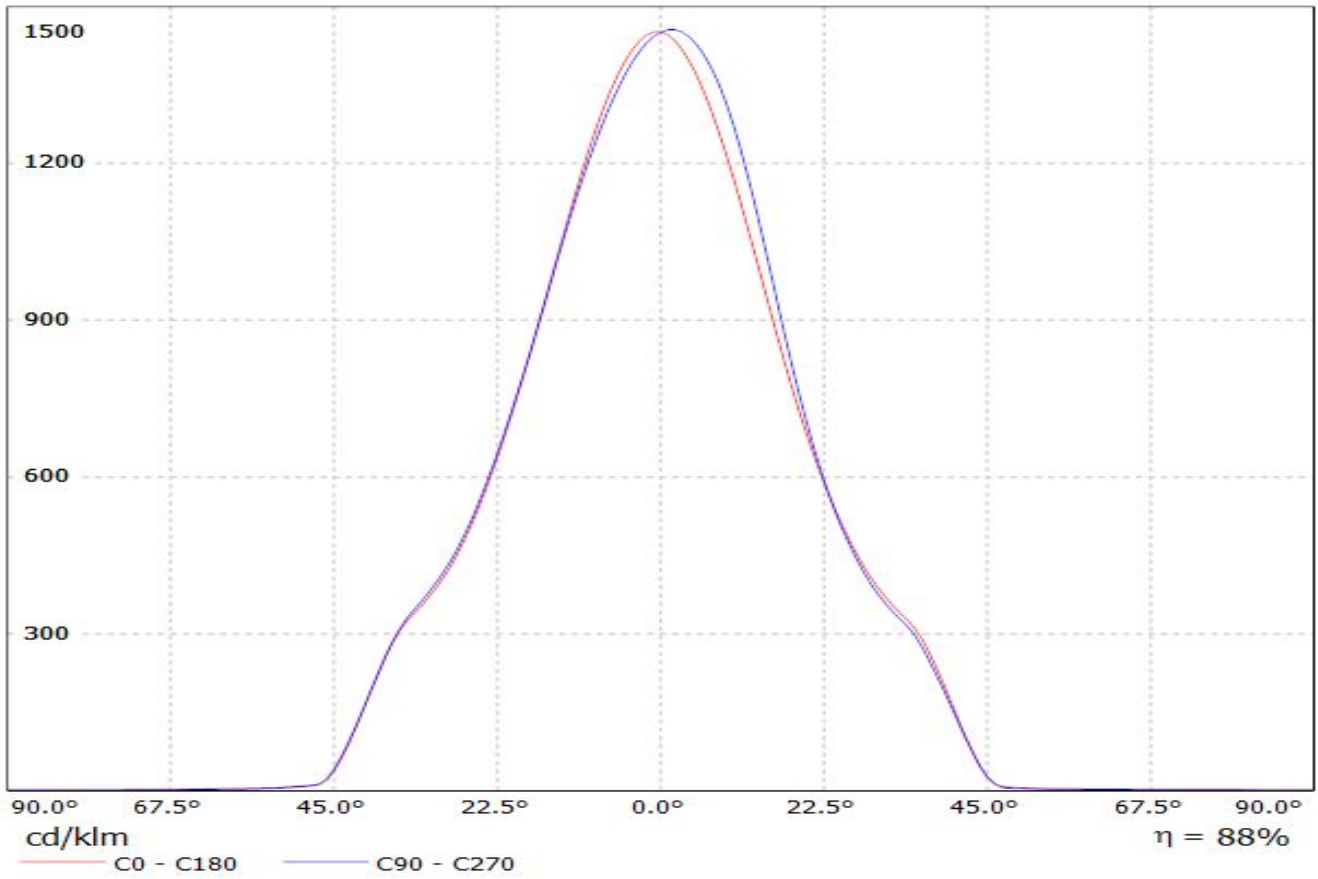

Luminaire: LEDiL Oy CN13129_MIRELLA-50-W-PF_(SLE-G5_LES-6)_C13083_PF-SOCKET
Lamps: 1 x Tridonic_SLE-G5_LES-6_468.743lm@100mA_P=3.3717W_I=0.100A

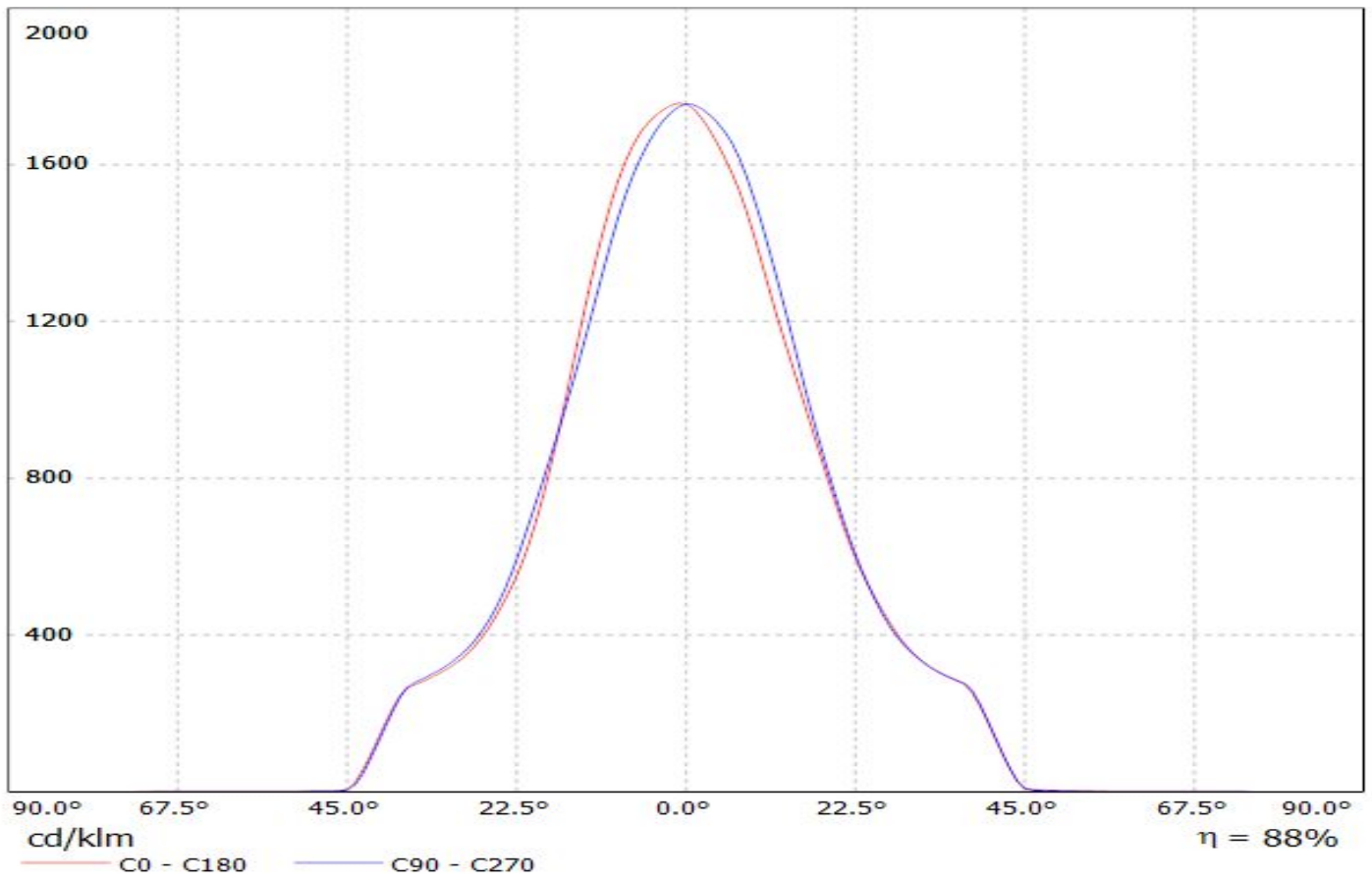

Luminaire: LEDiL Oy CN13129_MIRELLA-50-W-PF_(SLE-G5_LES-11)
Lamps: 1 x Tridonic_SLE-G5_LES-11_1166.25lm@250mA_P=8.3218W_I=0.250A

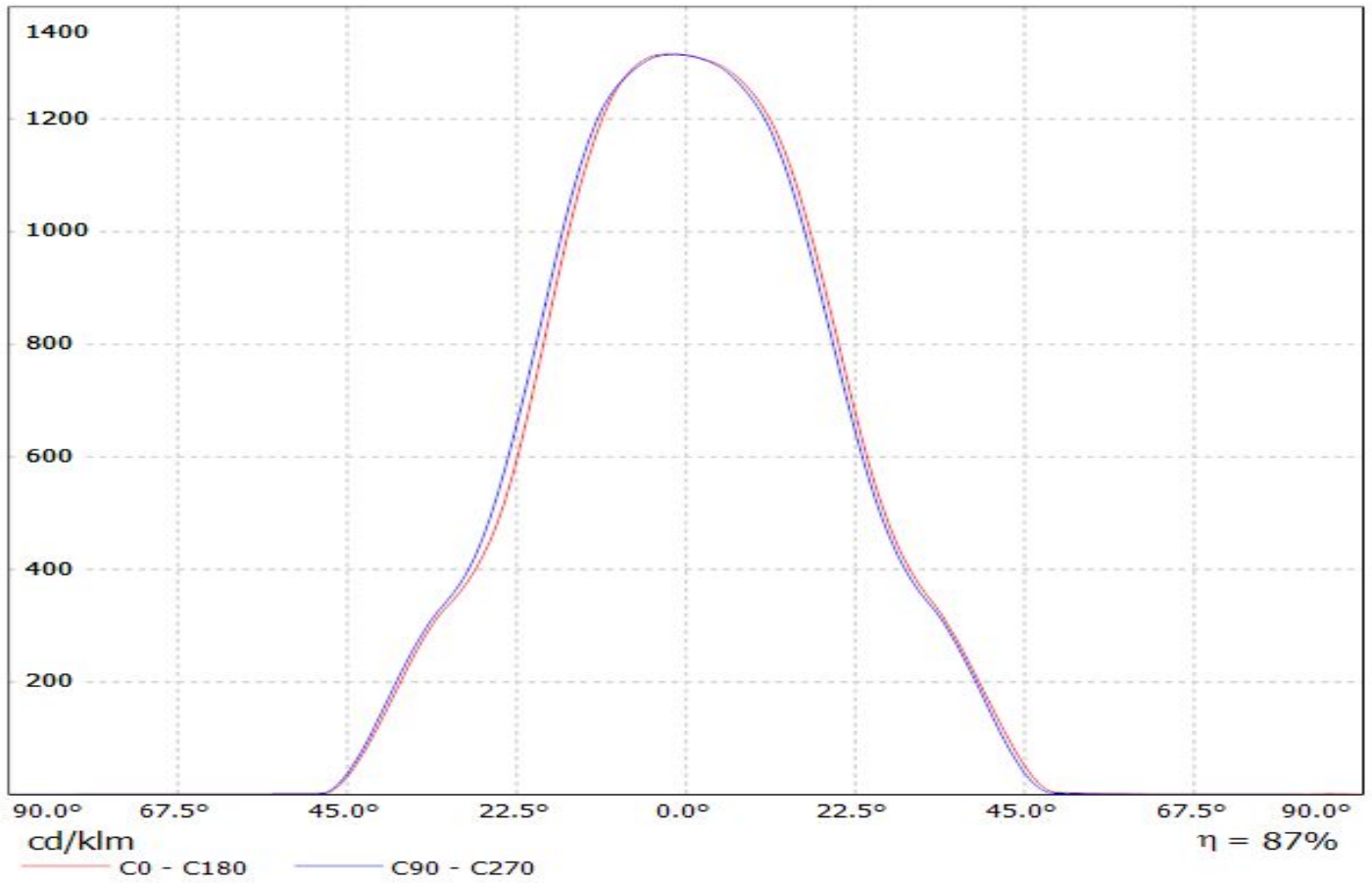

Luminaire: LEDiL Oy CN13129_MIRELLA-50-W-PF_(CLU700)

Lamps: 1 x Citizen_CLU700_C13083_PF-SOCKET_394.785lm@100mA_P=2.92999W_I=0.1044A

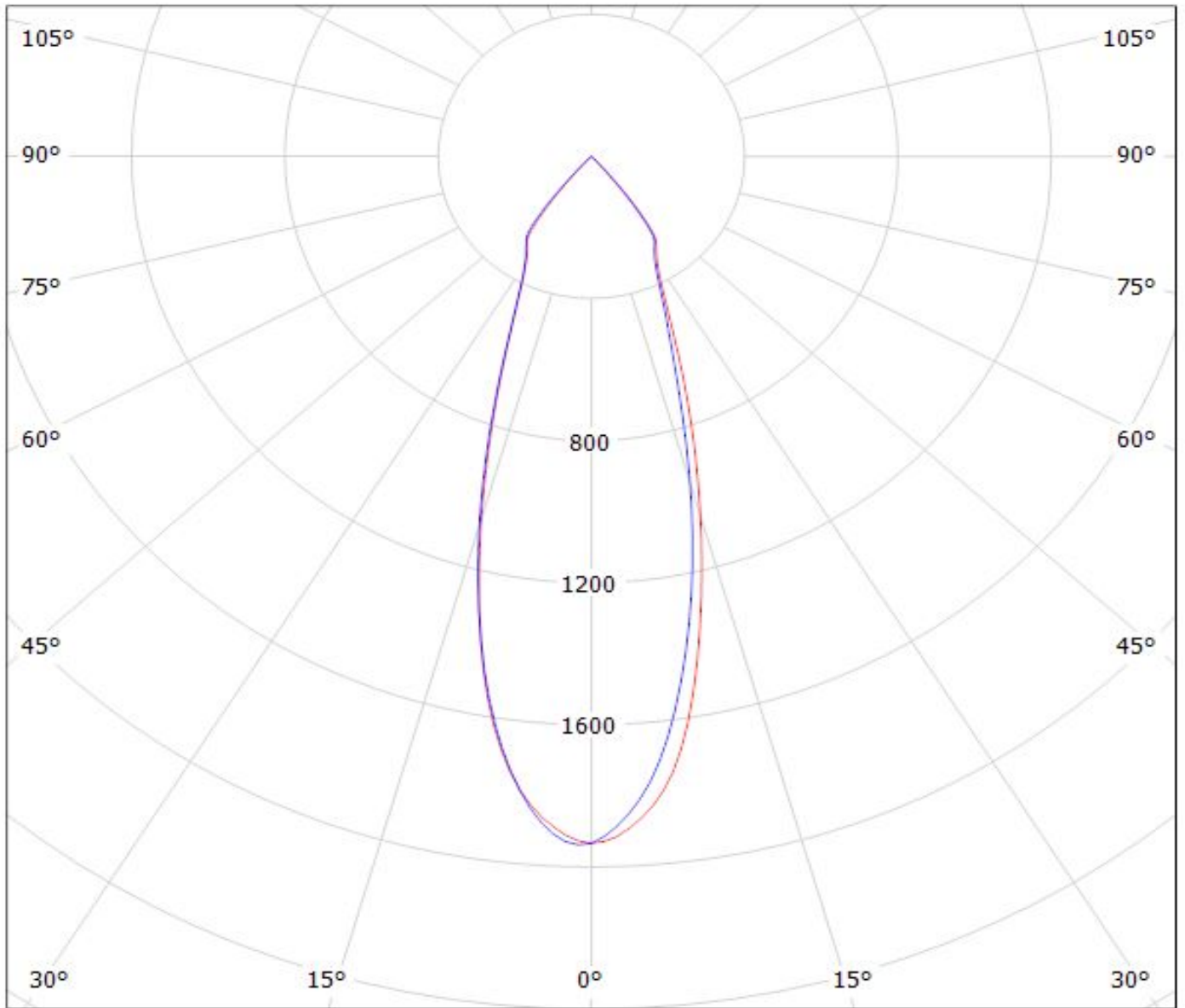

cd/klm

$\eta = 88\%$

— C0 - C180

— C90 - C270

Luminaire: LEDiL Oy CN13129_MIRELLA-50-W-PF_(MK-R) Eff.85.3%
Lamps: 1 x CREE_MK-R_358.348lm@250mA_P=2.84311W_I=249.9mA

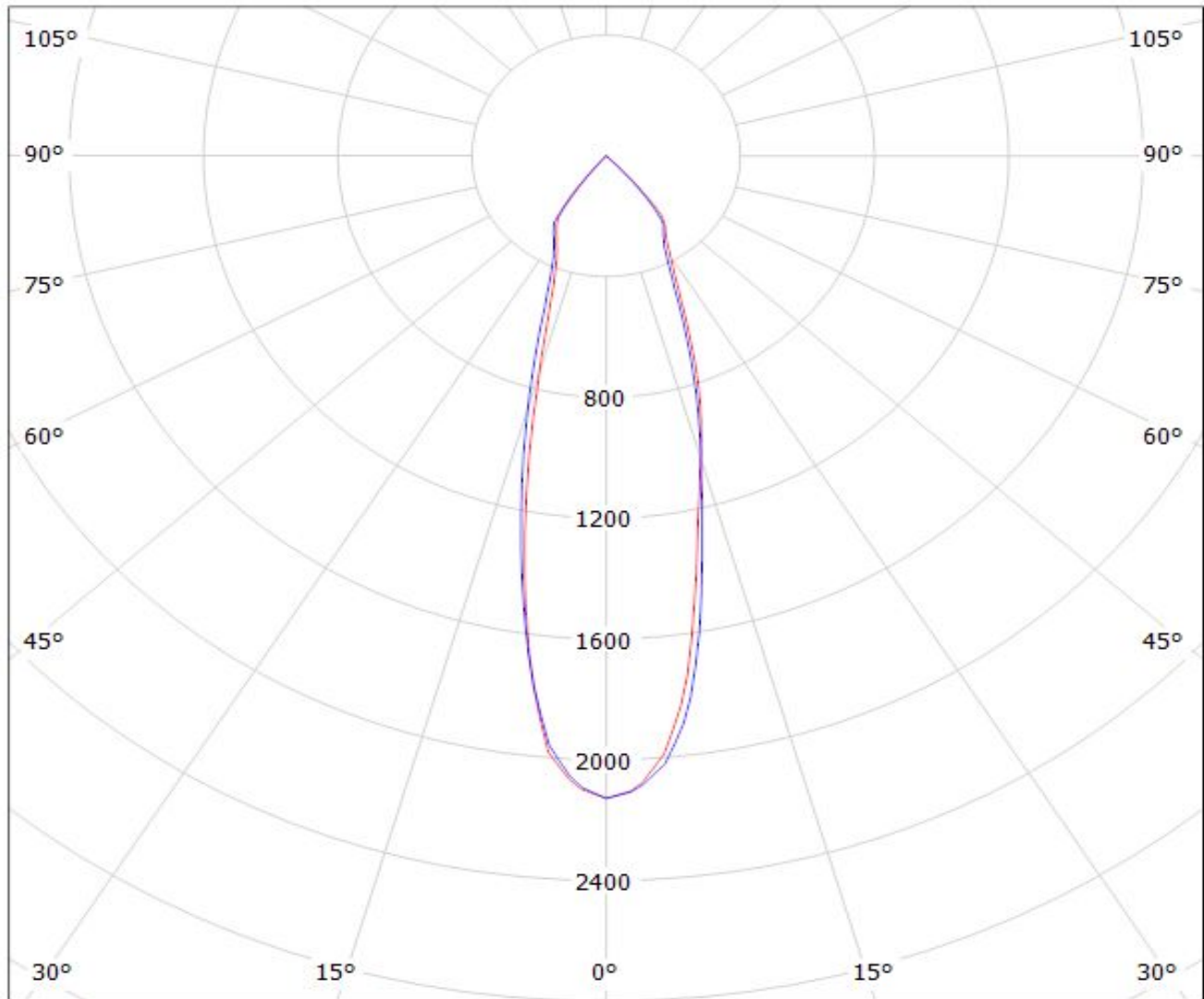

cd/klm

$\eta = 85\%$

— C0 - C180

— C90 - C270

Luminaire: LEDiL Oy CN13129_MIRELLA-50-W-PF_(Cree_XHP70)
Lamps: 1 x Cree_XHP70_261.339lm@250mA_P=1.3827W_I=0.2499A

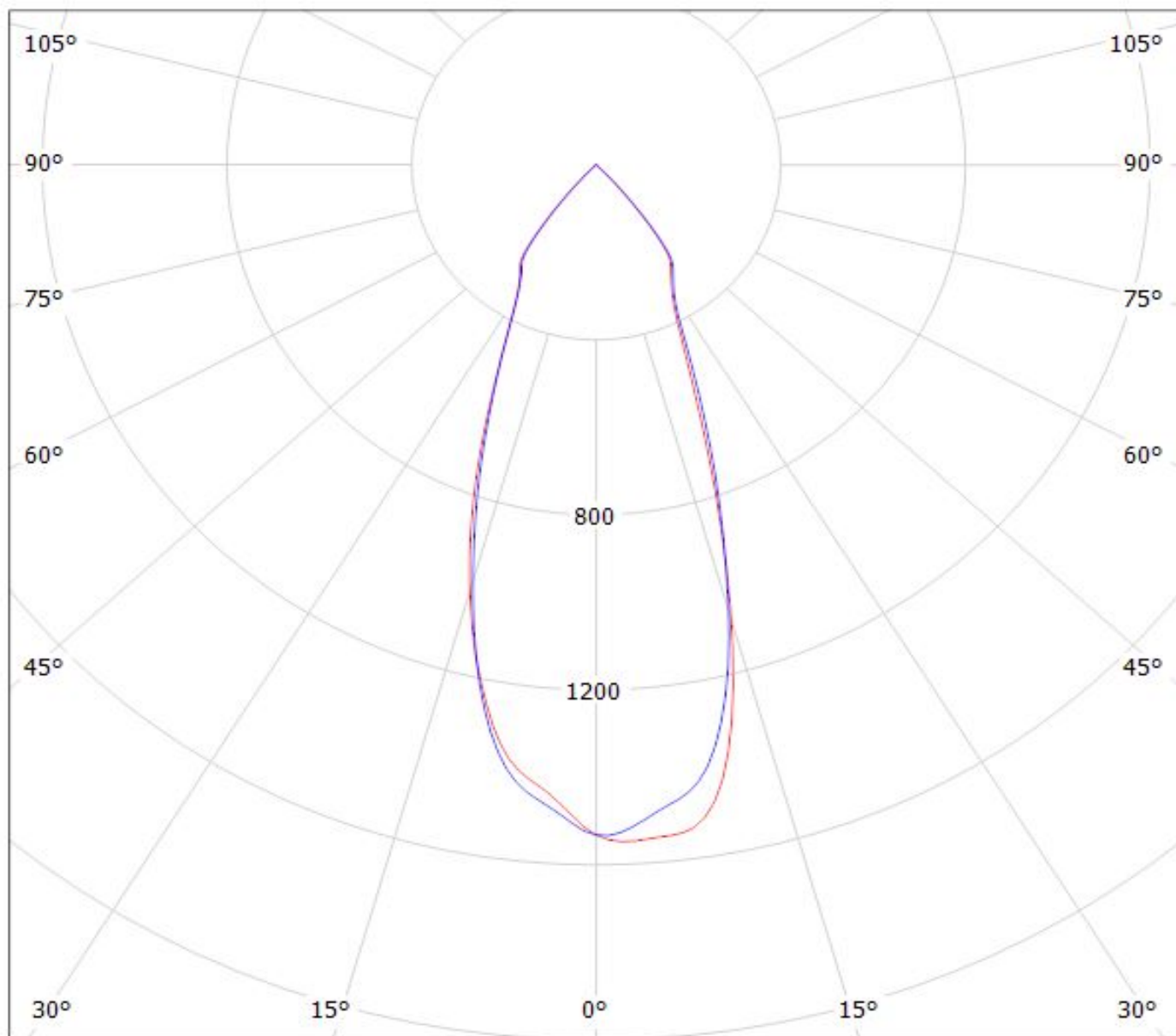

cd/klm

— C0 - C180 — C90 - C270

$\eta = 86\%$

Luminaire: LEDiL Oy CN13129_MIRELLA-50-W-PF_(Cree_XHP50_WW)
Lamps: 1 x Cree_XHP50_WW_196.271lm@250mA_P=1.39897W_l=0.2499A

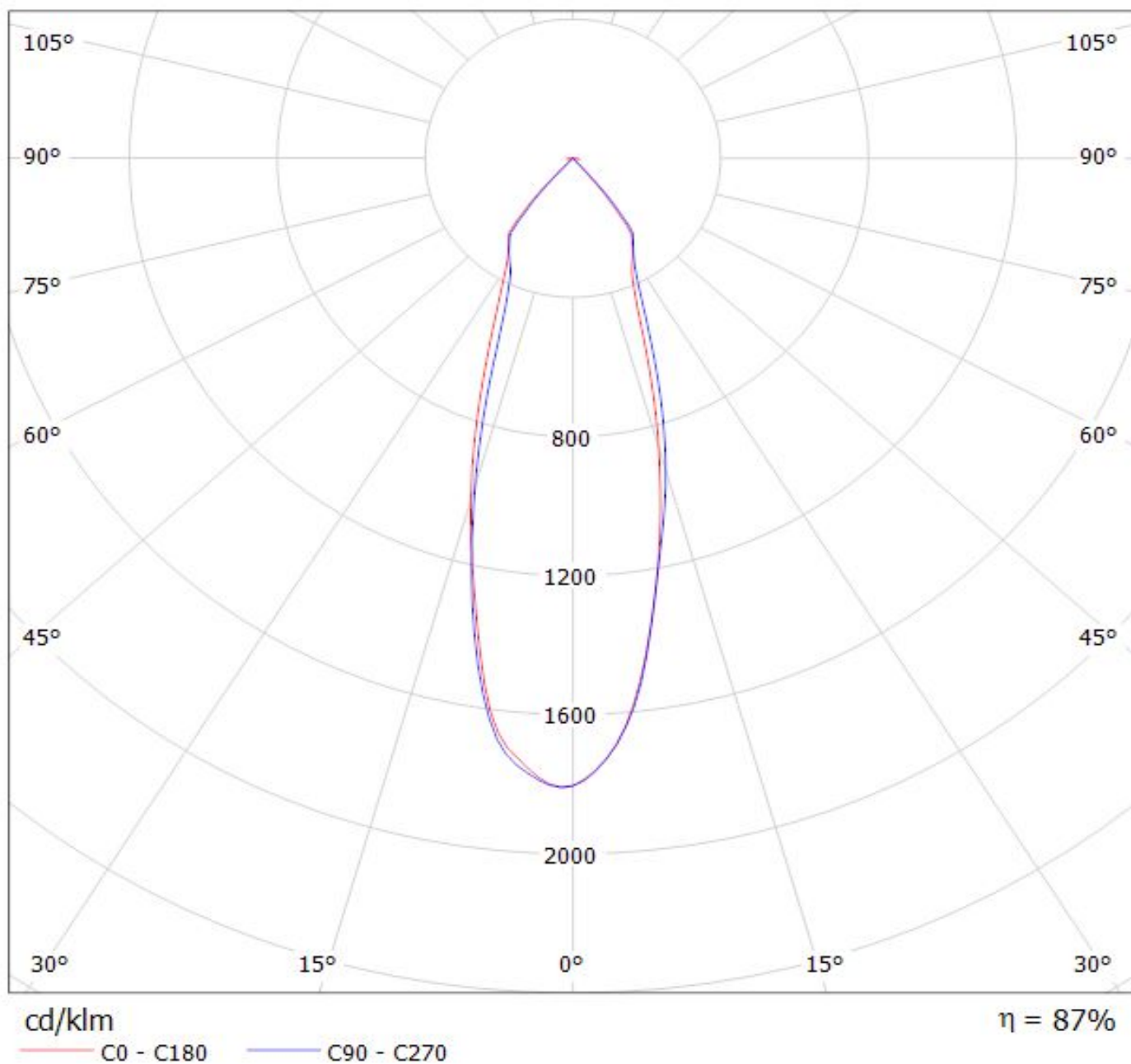

Luminaire: Ledil CN13129_MIRELLA-50-W-PF_(MHD-G)
Lamps: 1 x Cree MHD-G_530.44lm@100mA_P=3.0W_I=0.100A

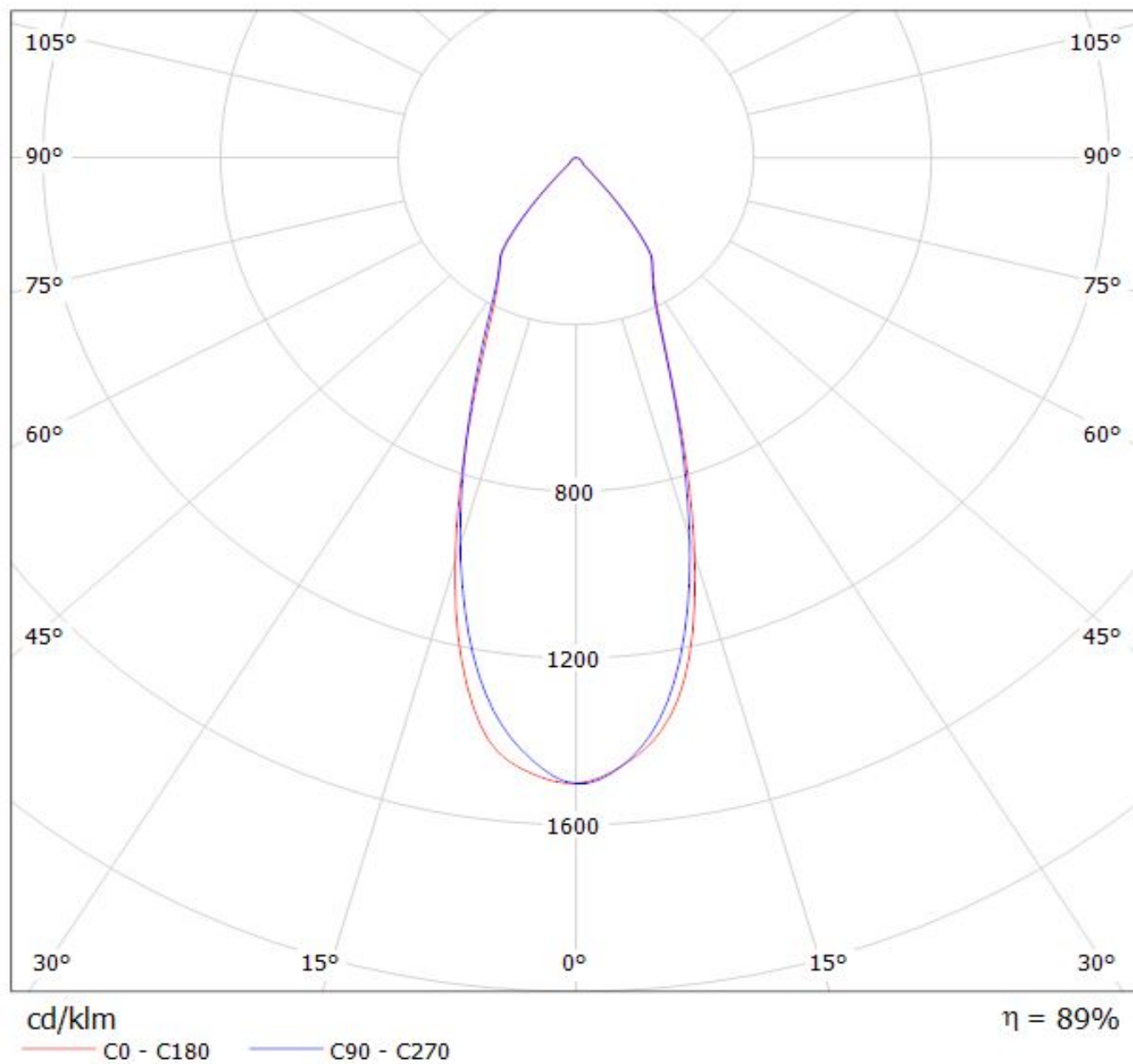

Luminaire: LEDil Oy CN13129_MIRELLA-50-W-PF_(CXM-6) Efficiency=85%
Lamps: 1 x Luminus XNOVA CXM-6 (437lm @ 120mA) CCT=3200K P=4.2W I=120mA

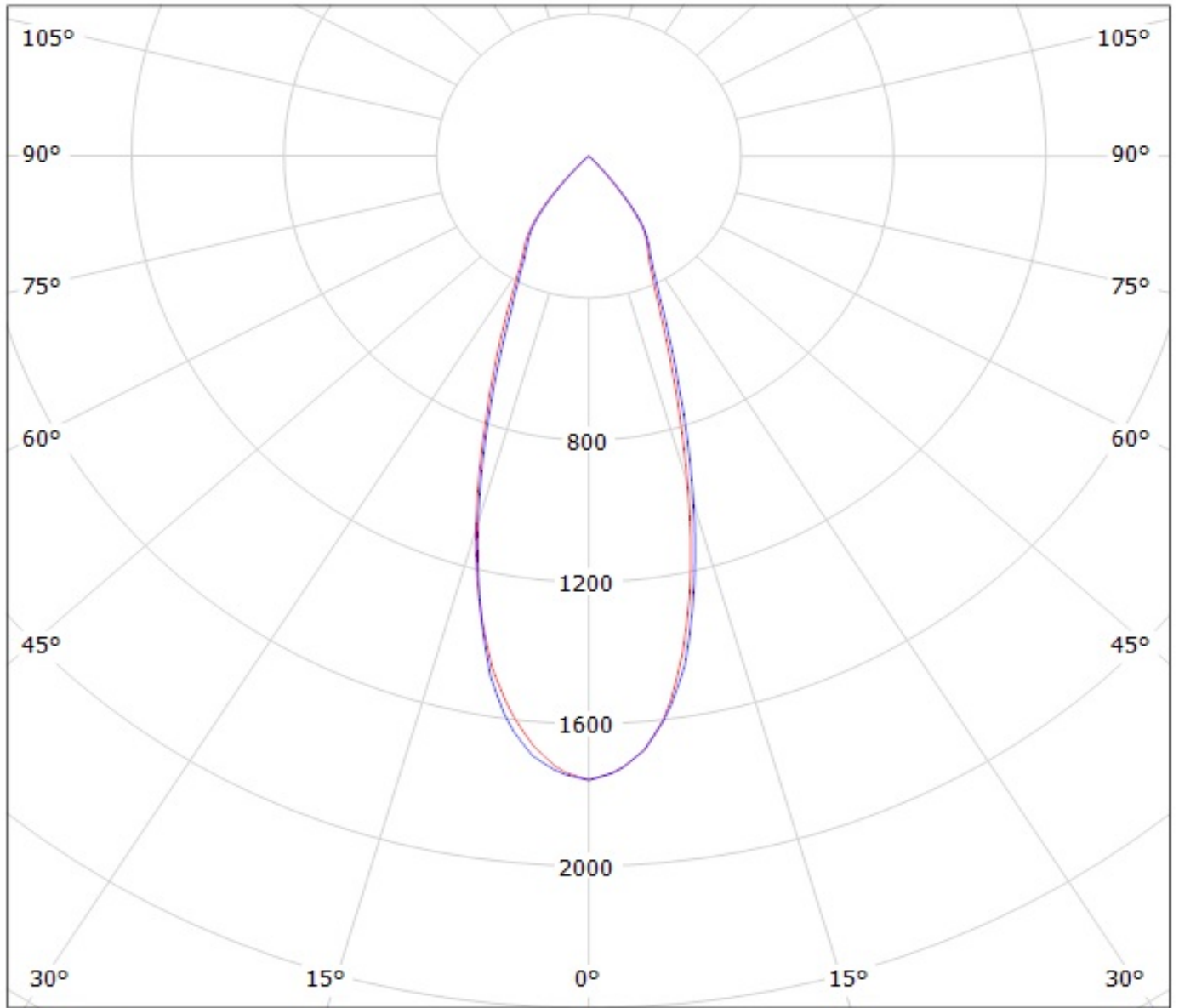

cd/klm

— C0 - C180 — C90 - C270

Luminaire: LEDil Oy CN13129_MIRELLA-50-W-PF_(CXM-7) Efficiency=86%
Lamps: 1 x Luminus XNOVA CXM-7 (522lm @ 160mA) CCT=2900K P=5.6W I=160mA

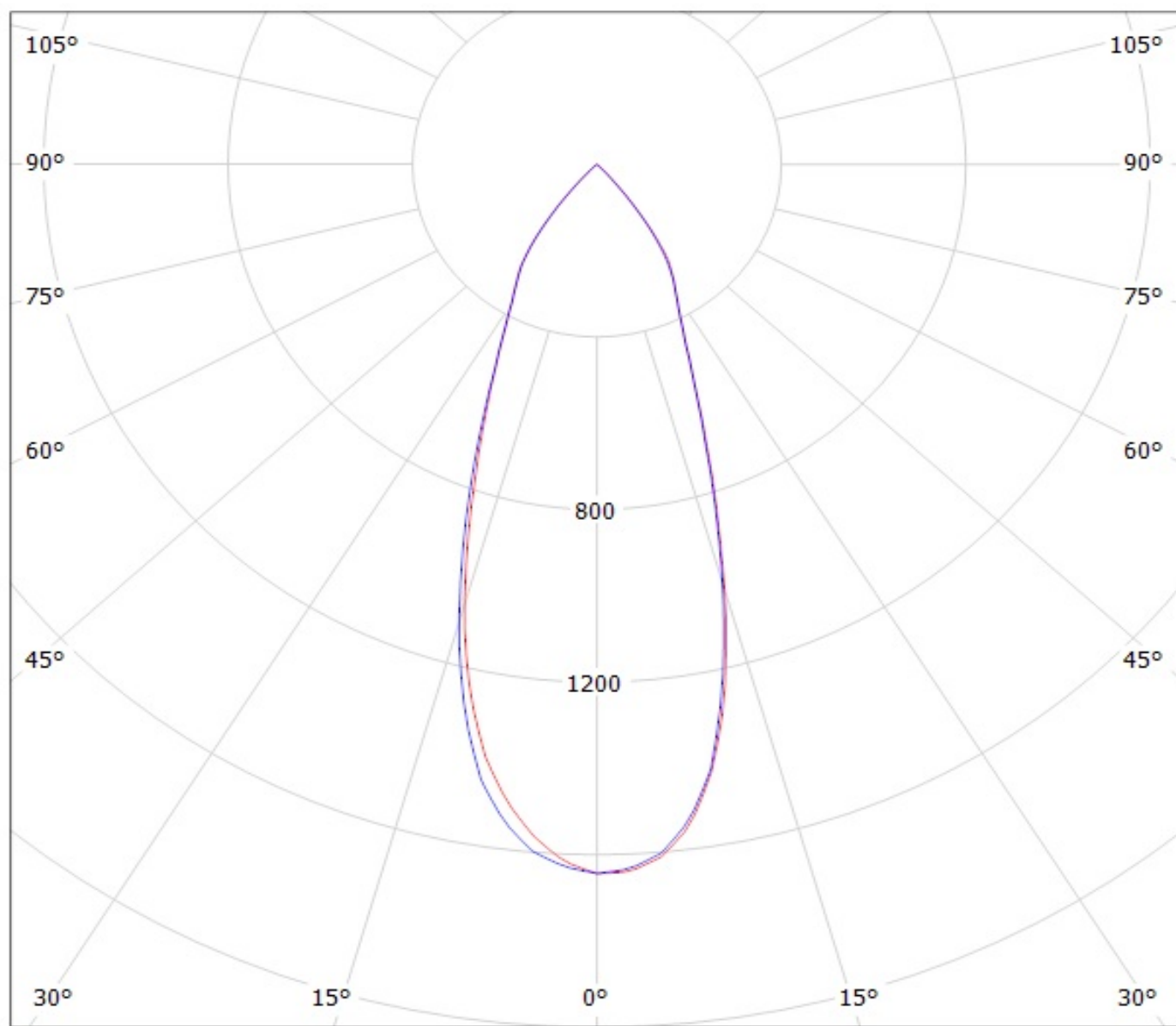

cd/klm

— C0 - C180

— C90 - C270

Luminaire: LEDiL Oy CN13129_MIRELLA-50-W-PF_(CXM-9)

Lamps: 1 x Luminus_XNOVA_CXM-9_(AA00)_974.297lm@240mA_P=8.2836W_I=240mA

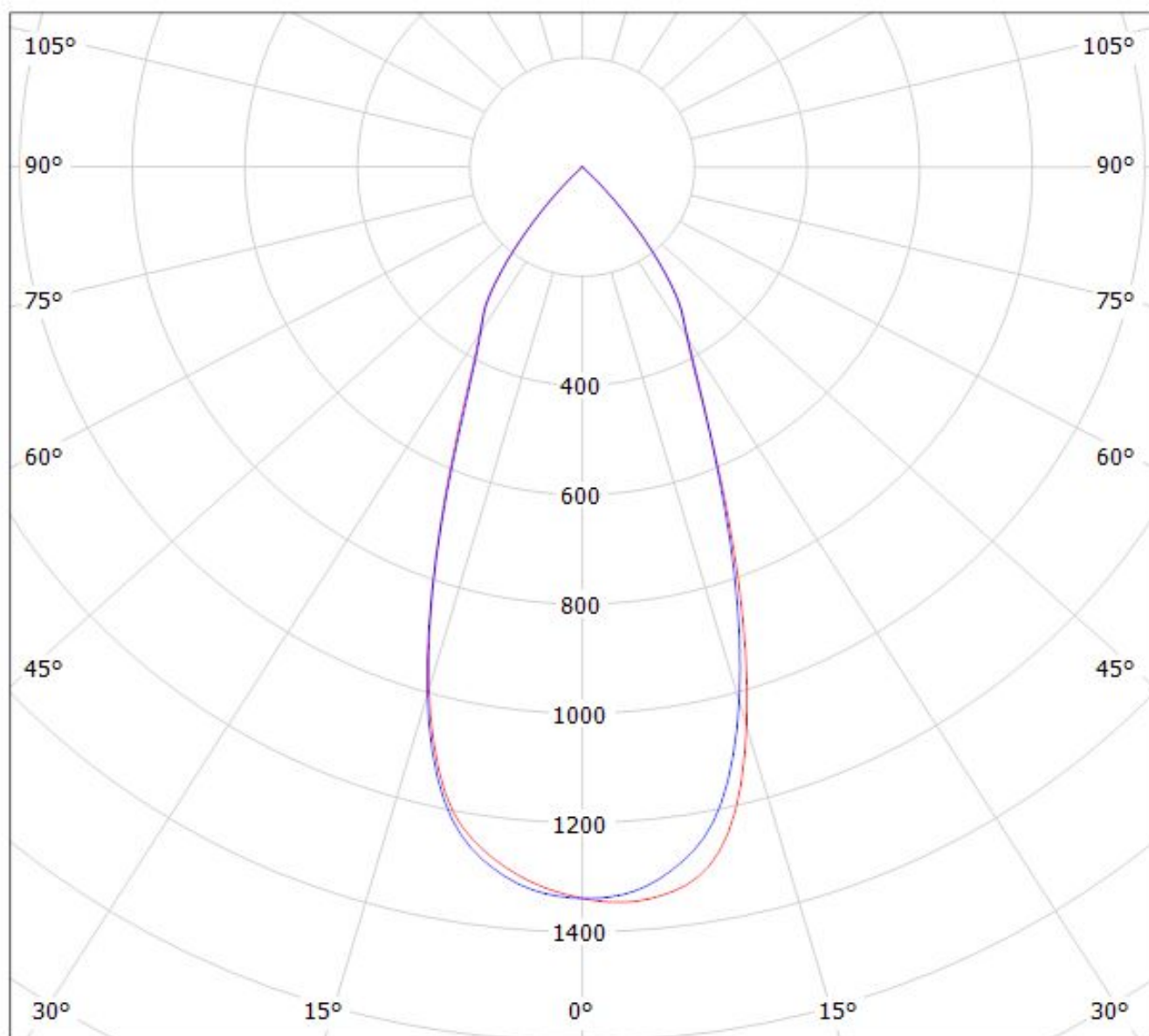

cd/klm

$\eta = 88\%$

— C0 - C180

— C90 - C270

Luminaire: Ledil Oy CN13129_MIRELLA-50-W-PF_(Soleriq_S9)_SIMULATED
Lamps: 1 x Osram Soleriq S9 (GW KAJFB3.EM)

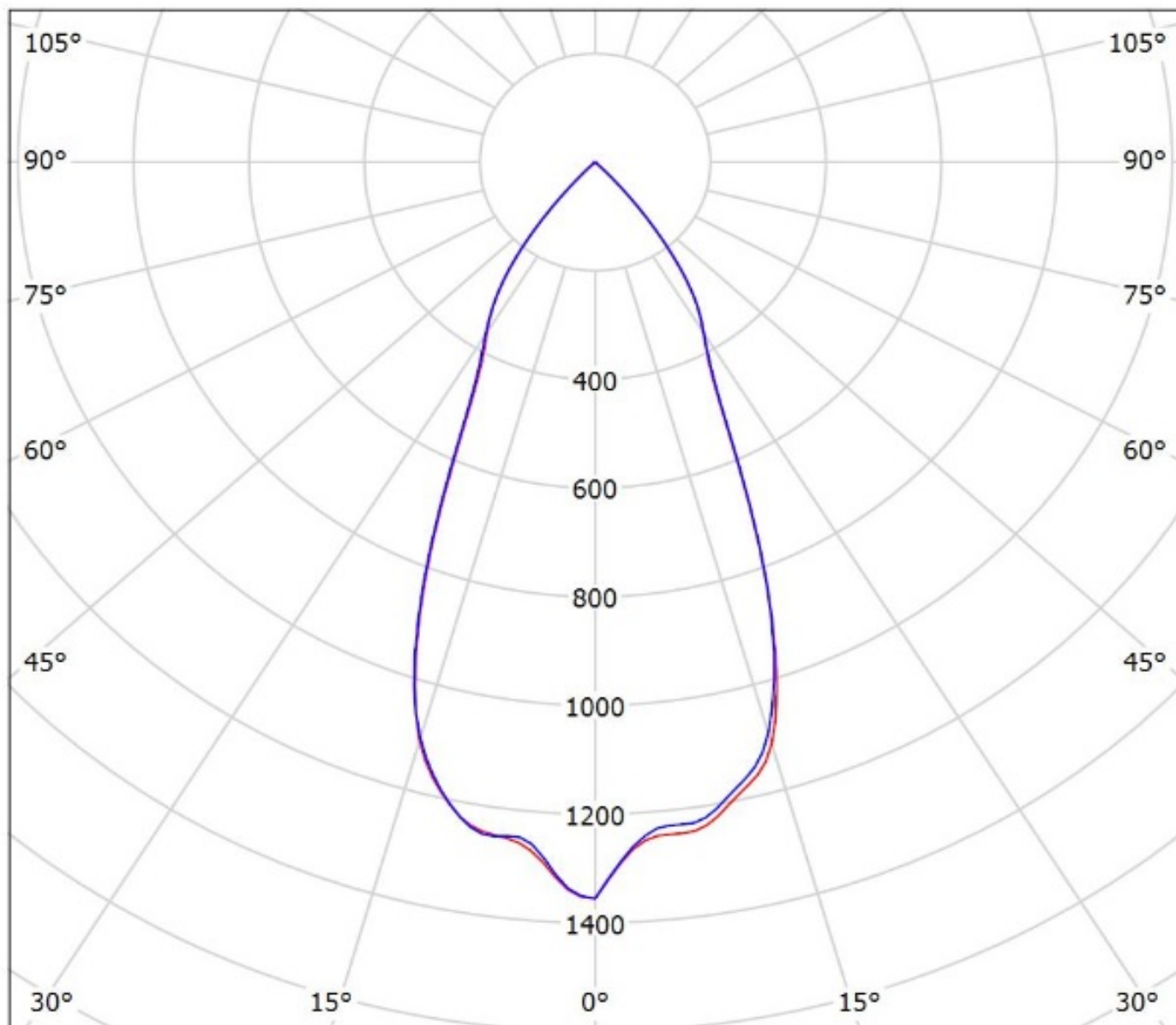

cd/klm

— C0 - C180 — C90 - C270

$\eta = 91\%$

Luminaire: LEDil Oy CN13129_MIRELLA-50-W-PF_(ZC6) Efficiency=86%
Lamps: 1 x Seoul ZC6 (SDW81F1C) 422lm @ 100mA CCT=3100K P=3.4W I=100mA

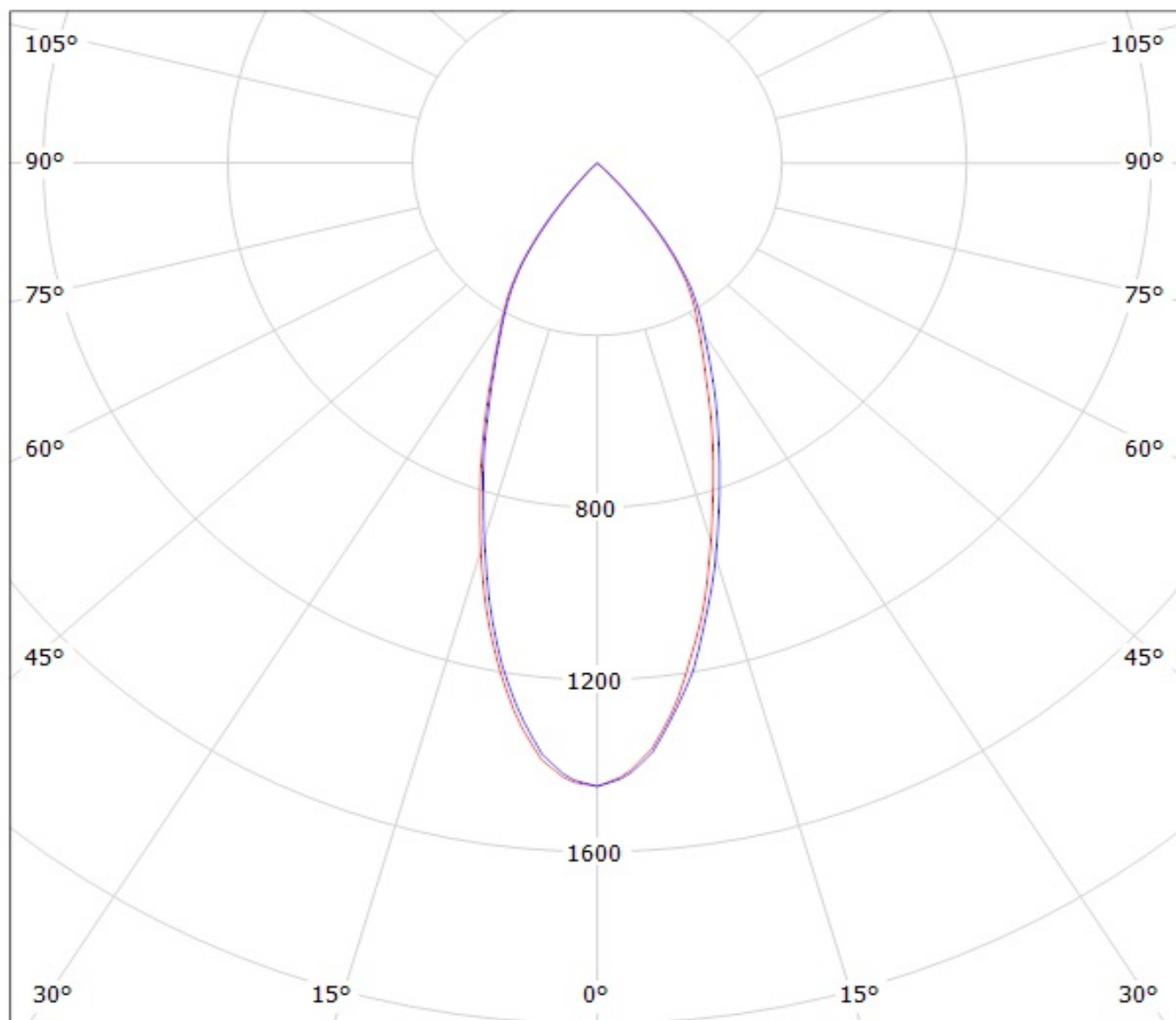

cd/klm

— C0 - C180

— C90 - C270

Luminaire: LEDiL Oy CN13129_MIRELLA-50-W-PF (Mini_Zenigata_GW6BM) Eff.87.7%
Lamps: 1 x Mini_Zenigata_GW6BM (803.772lm@250mA)

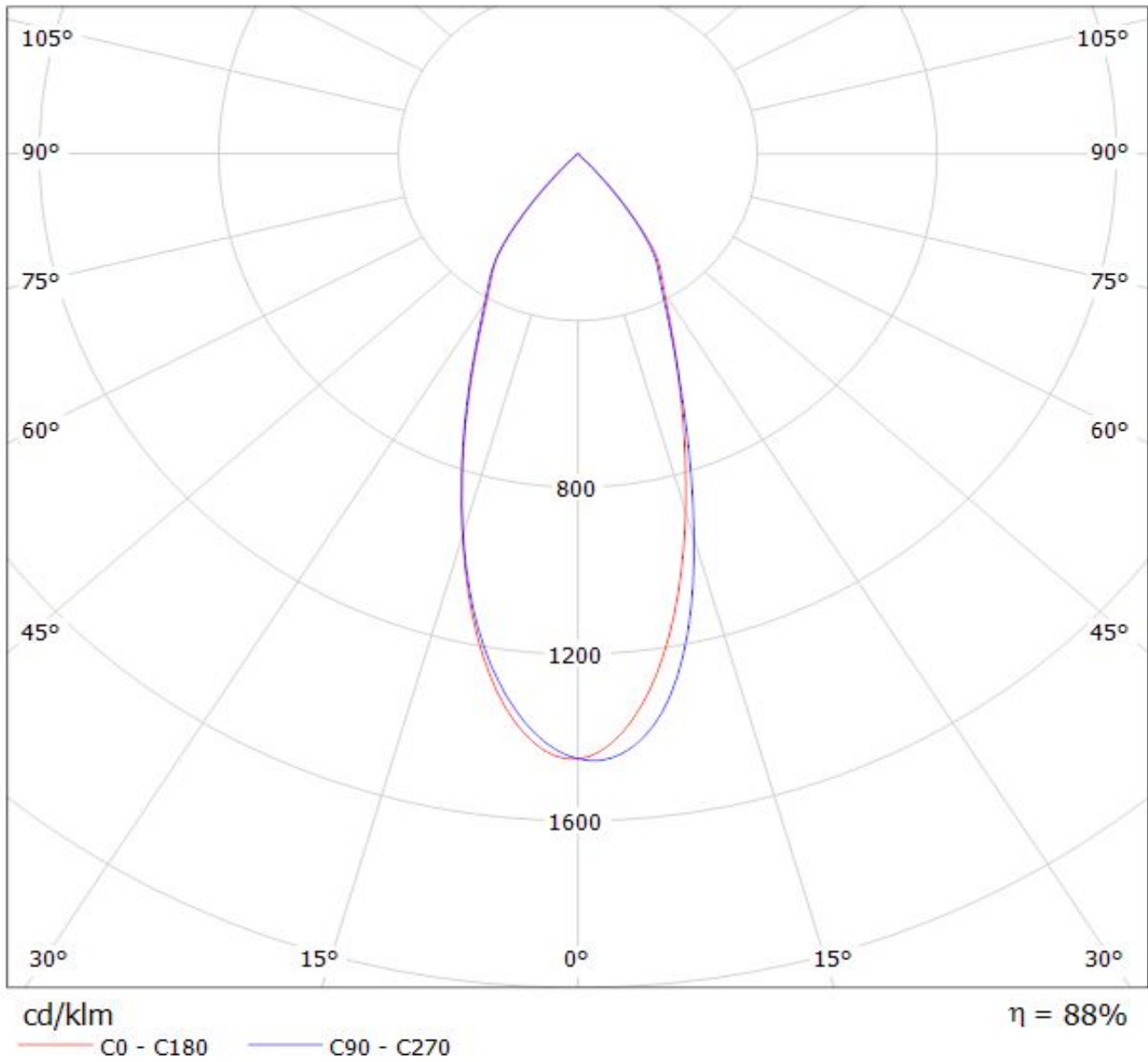

Luminaire: LEDiL Oy CN13129_MIRELLA-50-W-PF_(SLE-G5_LES-6)_ (C13083_PF-SOCKET)
Lamps: 1 x Tridonic_SLE-G5_LES-6_468.743lm@100mA_P=3.3717W_I=0.100A

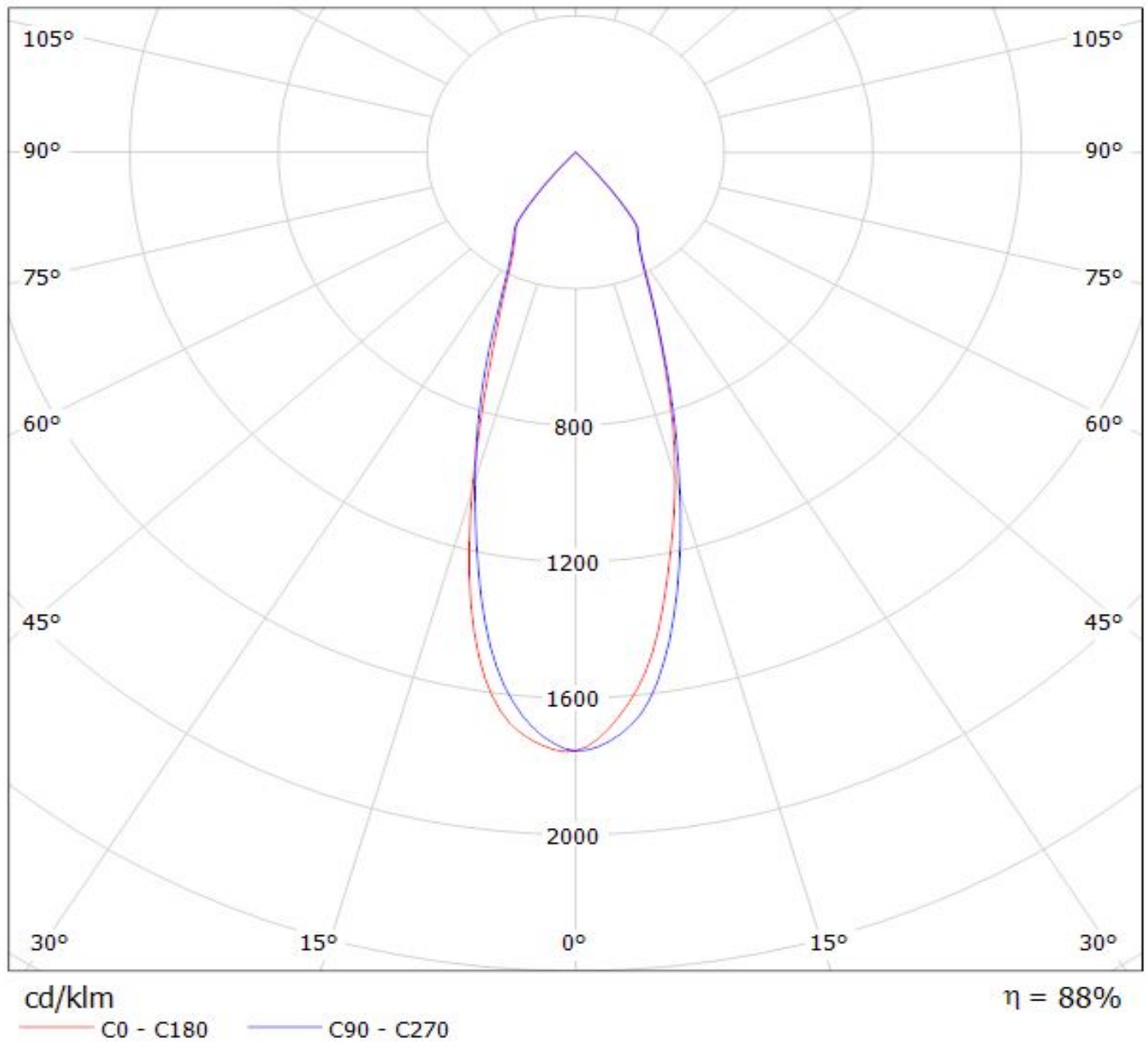

Luminaire: LEDiL Oy CN13129_MIRELLA-50-W-PF_(SLE-G5_LES-11)

Lamps: 1 x Tridonic_SLE-G5_LES-11_1166.25lm@250mA_P=8.3218W_I=0.250A

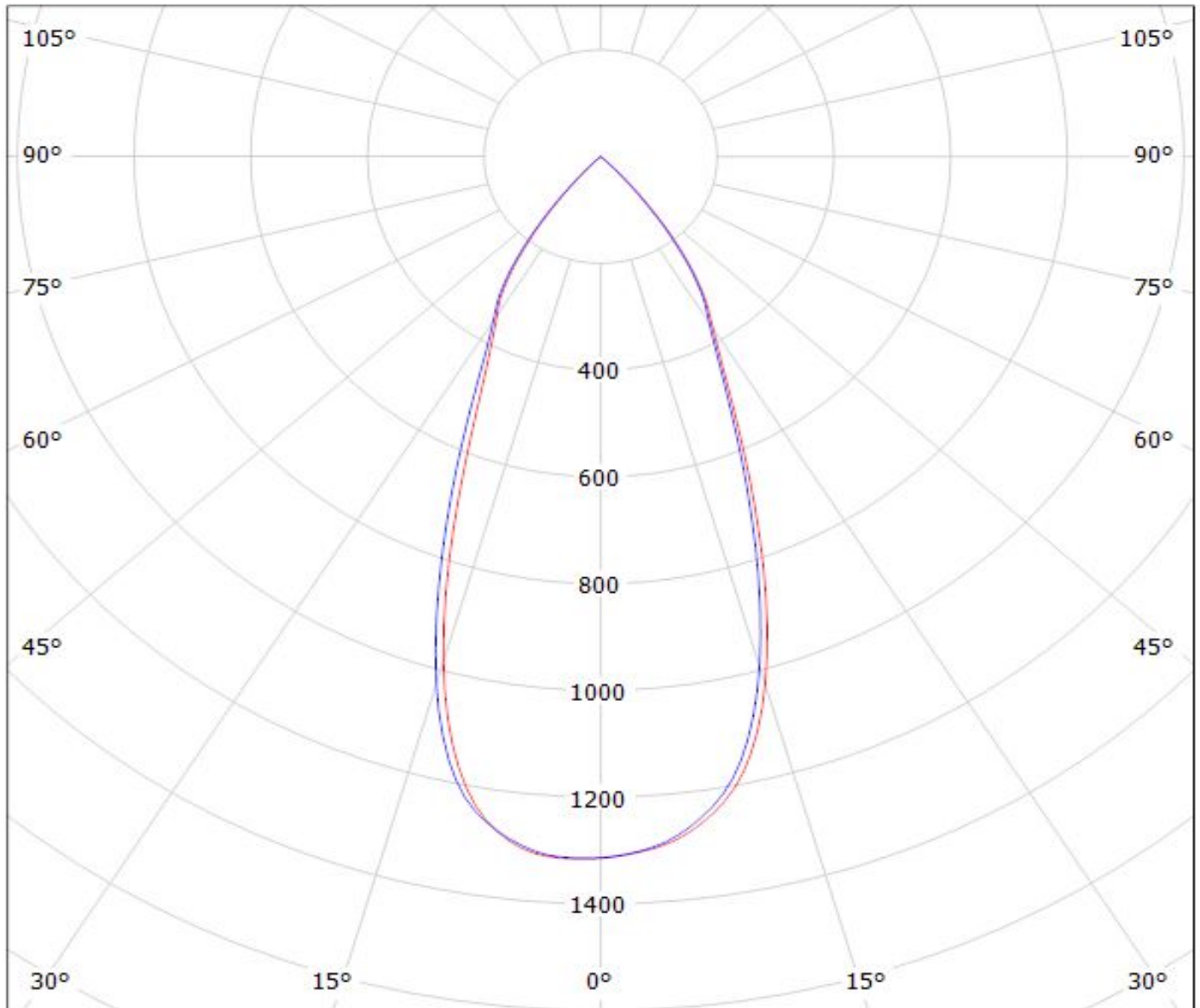

cd/klm

— C0 - C180 — C90 - C270

$\eta = 87\%$

NOTE: The typical divergence will be changed by different color, chip size and chip position tolerance. The typical total divergence is the full angle measured where the luminous intensity is half of the peak value.

GENERAL INFORMATION

- Product series especially designed & optimized for series of LEDs.
- Special care taken to make light distribution as uniform as possible.

Note! Due to use of high power COB's with this product, special attention to proper thermal design is highly recommended. LEDiL has no liability for direct, indirect or consecutive damages arising from the LEDiL products being used outside of the recommended temperature range.